

ABE7R16T370

sub-base - soldered electromechanical relays ABE7 -
16 channels - relay 12.5 mm



Main

Range of product	Advantys Telefast ABE7
Product or component type	Sub-base with plug-in electromechanical relay
Sub-base type	Output sub-base
[Us] rated supply voltage	19...30 V conforming to IEC 61131-2
Number of channels	16

Complementary

Supply circuit type	DC
Product compatibility	ABR7S37
Status LED	1 LED per channel, green for channel status 1 LED, green for power ON
Polarity distribution	Volt-free
Short circuit protection	1 A internal fuse, 5 x 20 mm, fast blow (PLC end)
Fixing mode	By clips on 35 mm symmetrical DIN rail By screws on solid plate with fixing kit
Supply current	<= 1 A
Voltage drop on power supply fuse	0.3 V
[Ui] rated insulation voltage	2000 V between terminals/mounting rails 300 V between coil circuit/contact circuits conforming to IEC 60947-1
[Uimp] rated impulse withstand voltage	2.5 kV
Installation category	II conforming to IEC 60664-1
Tightening torque	0.6 N.m (with flat Ø 3.5 mm)
Product weight	1.3 kg

Environment

Product certifications	BV CSA DNV GL LROS (Lloyds register of shipping)
IP degree of protection	IP2x conforming to IEC 60529
Resistance to incandescent wire	750 °C conforming to IEC 60695-2-11
Shock resistance	15 gn for 11 ms conforming to IEC 60068-2-27
Vibration resistance	2 gn (f = 10...150 Hz) conforming to IEC 60068-2-6
Resistance to electrostatic discharge	4 kV (contact) conforming to IEC 61000-4-2 level 3 8 kV (air) conforming to IEC 61000-4-2 level 3
Resistance to radiated fields	10 V/m (26000000...1000000000 Hz) conforming to IEC 61000-4-3 level 3
Resistance to fast transients	2 kV conforming to IEC 61000-4-4 level 3
Ambient air temperature for operation	-5...60 °C conforming to IEC 61131-2
Ambient air temperature for storage	-40...80 °C conforming to IEC 61131-2
Pollution degree	2 conforming to IEC 60664-1

Dimensions

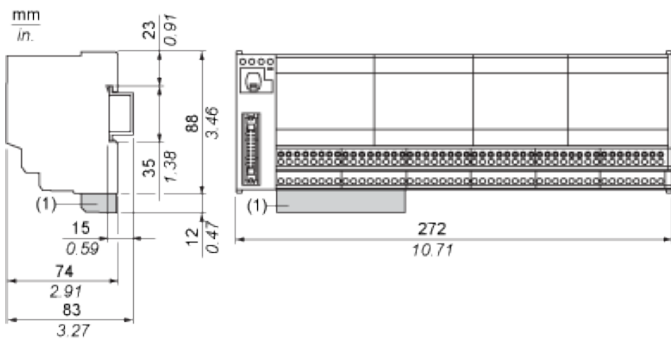

(1) ABE7BV10 / BV20, ABE7BV10E / BV20E

Mounting

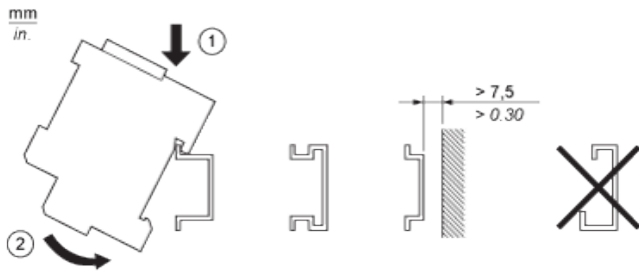

HE10 16 Channels

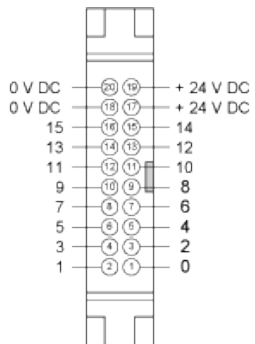

Wiring Diagram with Other Relays not Supplied

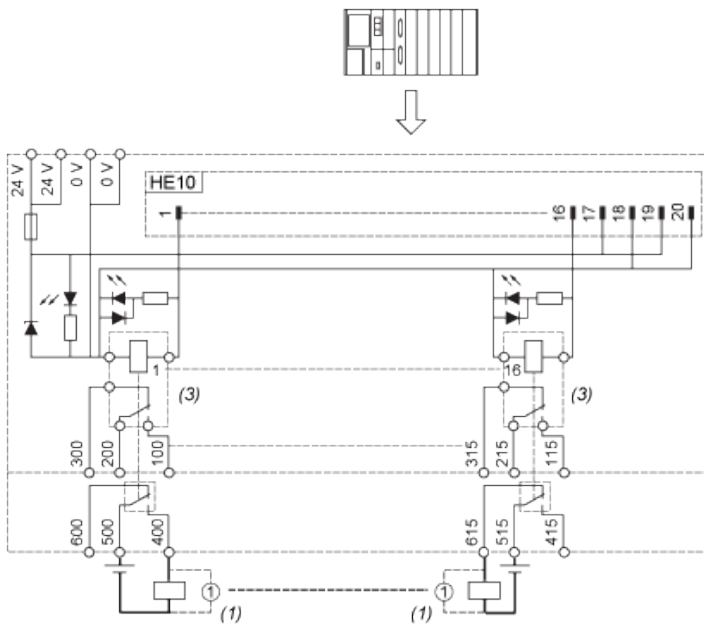

- (1) Inductive load
- (3) ABR7S37 (2 "OF" "DPDT") Ith = 8 A (supplied)

Curves for Determining Cable Type and Length According to the Current

16-channel Sub-base

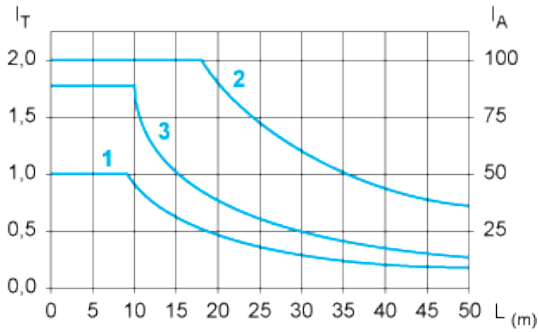

L Cable length

I_T Total current per sub base (A)

I_A Average current per channel (mA)

- (1) TSXCDP••2 and ABFH20H••0 cables with c.s.a. 0.08 mm² (AWG 28).
- (2) TSXCDP••3 cables with c.s.a. 0.34 mm² (AWG 22).
- (3) Cables with c.s.a. 0.13 mm² (AWG 26).

The curves are given for a voltage drop of 1 V in the cable. For n volts tolerance, multiply the length determined from the graph by n.

Temperature Derating Curves

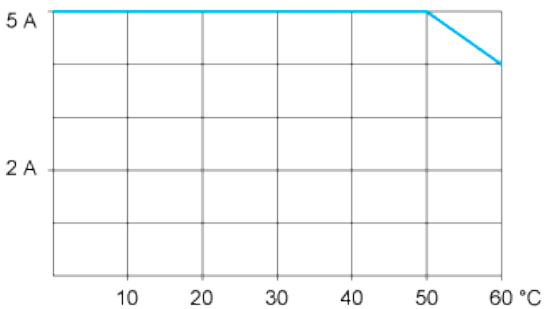

Electrical Durability (in Millions of Operating Cycles) Conforming to IEC 60947-5-1

DC Loads

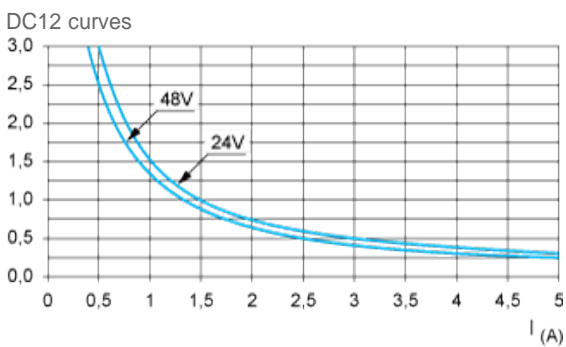

DC12 control of resistive loads and of solid state loads isolated by optocoupler, $I/R \leq 1$ ms.

DC13 curves

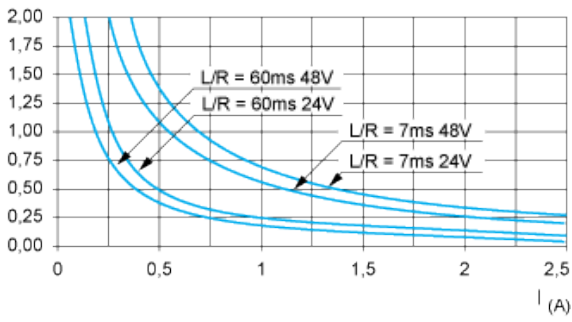

DC13 switching electromagnets, $L/R \leq 2 \times (U_e \times I_e)$ in ms, U_e : rated operational voltage, I_e : rated operational current (with a protective diode on the load, DC12 curves must be used with a coefficient of 0.9 applied to the number in millions of operating cycles)

AC Loads

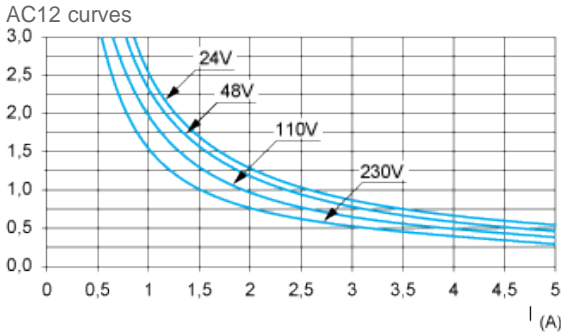

AC12 control of resistive loads and of solid state loads isolated by optocoupler, $\cos \phi \geq 0.9$.

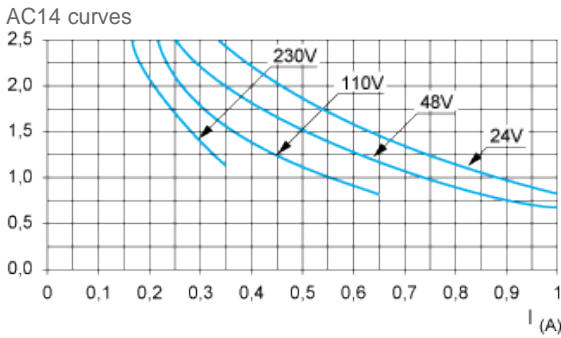

AC14 control of small electromagnetic loads $\leq 72 \text{ VA}$, make: $\cos \phi = 0.3$, break: $\cos \phi = 0.3$.

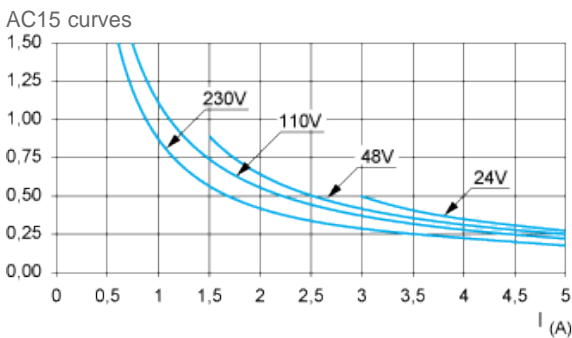

AC15 control of electromagnetic loads $> 72 \text{ VA}$, make: $\cos \phi = 0.7$, break: $\cos \phi = 0.4$.