

## Datasheet - ZR 236-11Z



Position switch / 236 thermoplastic enclosure - DIN EN 50047 with Actuator / 236 Roller plunger R

Preferred typ



- thermoplastic enclosure
- Good resistance to oil and petroleum spirit
- Wide range of alternative actuators
- 30 mm x 58,5 mm x 30 mm
- Snap action with constant contact pressure up to switching point
- 1 Cable entry M 20 x 1.5
- Double-insulated
- Mounting details to EN 50047
- Actuator heads can be repositioned by 4 x 90°

(Minor differences between the printed image and the original product may exist!)

### Ordering details

Product type description	ZR 236-11Z
Article number	101153241
EAN code	4030661168630

### Approval

Approval

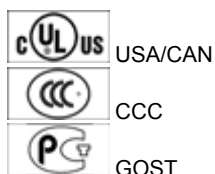

### Classification

Standards	ISO 13849-1
B <sub>10d</sub> Normally-closed contact (NC)	20.000.000
Mission time notice	20 Years
	$MTTF_d = \frac{B_{10d}}{0,1 \times n_{op}}$
	$n_{op} = \frac{d_{op} \times h_{op} \times 3600 \text{ s/h}}{t_{cycle}}$

### Global Properties

Product name	Z 236 Rollendruckbolzen R
Standards	IEC 60947-5-1, ISO 13849-1, BG-GS-ET-15
Compliance with the Directives (Y/N) 	Yes
Suitable for safety functions (Y/N)	Yes
Actuator type	C to EN 50047
Materials	
- Material of the housings	Plastic, glass-fibre reinforced thermoplastic, self-extinguishing
- Material of the contacts	Silver
Housing coating	None
Housing construction form	Norm construction design
Weight	60 g

## Mechanical data

Design of actuating element	Roller plunger
Design of electrical connection	Screw connection
Cable section	
- Min. Cable section	1.5 mm <sup>2</sup>
- Max. Cable section	2.5 mm <sup>2</sup>
Mechanical life	20.000.000 operations
Switching frequency	max. 5000/h
Actuating force	min. 9 N
Bounce duration	< 3 ms
Switchover time	< 5.5 ms
Positive break force	19 N
Actuating speed with actuating angle 30° to switch axis	
- Min. Actuating speed	20 mm/min
- Max. Actuating speed	1 m/s
notice	All indications about the cable section are including the conductor ferrules.

## Ambient conditions

Ambient temperature	
- Min. environmental temperature	-30 °C
- Max. environmental temperature	+80 °C
Protection class	IP67

## Electrical data

Design of control element	Normally open contact (NO), Opener (NC)
Switching principle	Snap switch element
- positive break NC contact 	
Number of auxiliary contacts	1 piece
Number of safety contacts	1 piece
Rated impulse withstand voltage U <sub>imp</sub>	6 kV
Rated insulation voltage U <sub>i</sub>	500 V
Thermal test current I <sub>the</sub>	10 A
Utilisation category	AC-15: 230 V / 4 A, DC-13: 24 V / 1 A
Required rated short-circuit current	1000 A
Max. fuse rating	6 A gG D-fuse

## Dimensions





### Dimensions of the sensor

- Width of sensor	30 mm
- Height of sensor	84 mm
- Length of sensor	30 mm

### Diagram





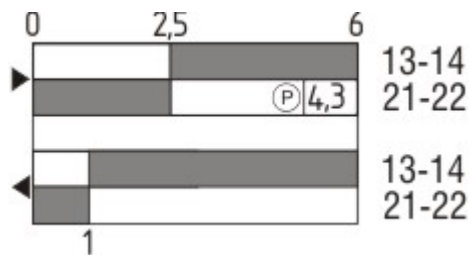

#### Note Diagram

-  positive break NC contact
-  active
-  no active
-  Normally-open contact
-  Normally-closed contact

### Switch travel diagram



#### Notes Switch travel diagram

-  Contact closed
  -  Contact open
  -  Setting range
  -  Break point
  -  Positive opening sequence/- angle
- VS** adjustable range of NO contact  
**VÖ** adjustable range of NC contact  
**N** after travel

### Ordering suffix

The applicable ordering suffix is added at the end of the part number of the safety switch.

Order example: ZR 236-11Z-1637

...-1637	0,3 µm gold-plated contacts
...- ID	IDC method of termination
...-NPT	Cable entry NPT 1/2"
...-1297	Enclosure with transverse slotted holes
	M12 connector with A-coding

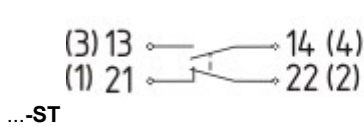

Rated impulse withstand voltage  $U_{imp}$ : 0,8 kV  
 Rated insulation voltage  $U_i$ : 50 V  
 Operating current  $I_e$ : AC-15: 50 V / 4 A  
 Caution! The versions with connector may only be used in PELV circuits to EN 60204-1.

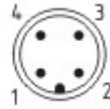
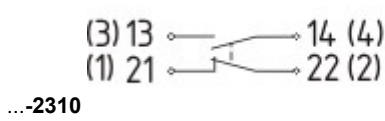

M12 connector with B-coding  
 Rated impulse withstand voltage  $U_{imp}$ : 0,8 kV  
 Rated insulation voltage  $U_i$ : 50 V  
 Operating current  $I_e$ : AC-15: 50 V / 4 A  
 Caution! The versions with connector may only be used in PELV circuits to EN 60204-1.

## Ordering code

(1)(2) 2(3)6-(4)Z(5)-(6)-(7)-(8)-(9)

(1)

Z

T

(2)

S

R

4S

4R

1R

K

3K

4K

K4

1H

7H

10H

12H

14H

AF

(3)

3

5

(4)

02

11

20

(5)

H

UE

(6)

without

ID

NPT

ST

2310

(7)

Snap action

Slow action

Plunger S

Roller plunger R

Plunger 4S

Roller plunger 4R

Offset roller lever 1R

Offset roller lever K

Angle roller lever 3K

Angle roller lever 4K

Angle roller lever K4

Roller lever 1H

Roller lever 7H

Rod lever 10H

Roller lever 12H

Roller lever 14H

Spring rod lever AF

slim design

large design

2 Opener (NC)

1 Normally open contact (NO) / 1 Opener (NC)

2 Normally open contact (NO), (Switch with 2 NO contacts are not for security tasks)

Slow action with staggered contacts

Slow action with overlapping contacts

Cable entry M20

IDC method of termination

cable entry NPT 1/2"

M12 connector with A-coding

M12 connector with B-coding

<b>1297</b>	Enclosure with transverse slotted holes
<b>(8)</b>	
<b>2138</b>	Roller lever 7H for Position switches with safety function
<b>(9)</b>	
<b>1637</b>	gold-plated contacts

## Documents

---

**Operating instructions and Declaration of conformity (da)** 304 kB, 21.08.2013

Code: mrl\_ZT235\_236\_da

**Operating instructions and Declaration of conformity (de)** 305 kB, 06.03.2014

Code: mrl\_ZT235\_236\_de

**Operating instructions and Declaration of conformity (en)** 338 kB, 06.03.2014

Code: mrl\_ZT235\_236\_en

**Operating instructions and Declaration of conformity (pt)** 308 kB, 21.08.2013

Code: mrl\_ZT235\_236\_pt

**Operating instructions and Declaration of conformity (es)** 303 kB, 02.01.2013

Code: mrl\_ZT235\_236\_es

**Operating instructions and Declaration of conformity (it)** 329 kB, 17.01.2013

Code: mrl\_ZT235\_236\_it

**Operating instructions and Declaration of conformity (fr)** 306 kB, 30.04.2013

Code: mrl\_ZT235\_236\_fr

**Operating instructions and Declaration of conformity (jp)** 410 kB, 14.01.2013

Code: mrl\_ZT235\_236\_jp

**Operating instructions and Declaration of conformity (nl)** 296 kB, 12.04.2013

Code: mrl\_ZT235\_236\_nl

**CCC certification (cn)** 324 kB, 03.02.2014

Code: q\_235p02

**CCC certification (en)** 352 kB, 03.02.2014

Code: q\_235p01

**Gost certification (ru)** 2 MB, 07.07.2011

Code: q\_az1p01

## Images

---

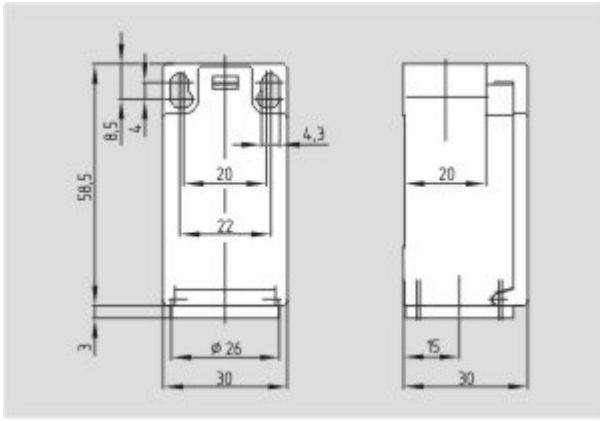

Dimensional drawing (basic component)

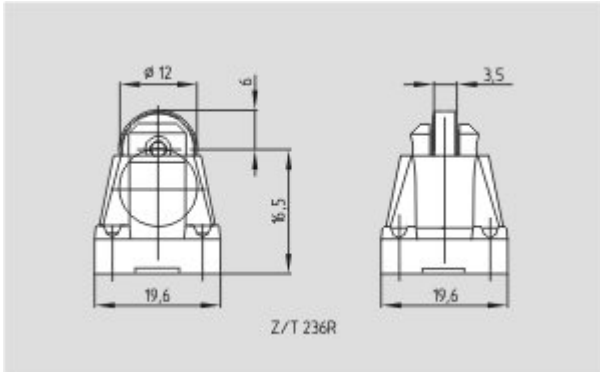

Dimensional drawing (actuator)

K.A. Schmersal GmbH & Co. KG, Mödinghofe 30, D-42279 Wuppertal

The data and values have been checked thoroughly. Technical modifications and errors excepted.

Generiert am 24.03.2014 - 11:51:37h Kasbase 2.2.18.F DBI

Image

Image  
et=sS