

Datasheet - ZR 256-11z



Position switch / Thermoplastic enclosure 256 - DIN EN 50047 with Actuator / 256 Roller plunger R

Preferred typ



- 2 cable entries M 20 x 1.5
- Snap action with constant contact pressure up to switching point
- Mounting details to EN 50047
- thermoplastic enclosure
- Double-insulated
- 58 mm x 50,5 mm x 31 mm
- Good resistance to oil and petroleum spirit
- Wide range of alternative actuators
- Actuator heads can be repositioned by 4 x 90°

(Minor differences between the printed image and the original product may exist!)

Ordering details

Product type description	ZR 256-11Z
Article number	101160535
EAN code	4030661190440

Approval

Approval



Classification

Standards	ISO 13849-1
B _{10d} Normally-closed contact (NC)	20.000.000
Mission time	20 Years
notice	$MTTF_d = \frac{B_{10d}}{0,1 \times n_{op}}$ $n_{op} = \frac{d_{op} \times h_{op} \times 3600 \text{ s/h}}{t_{cycle}}$

Global Properties

Product name	Z 256 Rollendruckbolzen R
--------------	---------------------------

Standards	IEC 60947-5-1, ISO 13849-1, BG-GS-ET-15
Compliance with the Directives (Y/N) 	Yes
Suitable for safety functions (Y/N)	Yes
Actuator type	C to EN 50047
Materials	
- Material of the housings	Plastic, glass-fibre reinforced thermoplastic, self-extinguishing
- Material of the contacts	Silver
Housing coating	None
Housing construction form	Norm construction design
Weight	85 g

Mechanical data

Design of electrical connection	Screw connection
Cable section	
- Min. Cable section	1.5 mm ²
- Max. Cable section	2.5 mm ²
Mechanical life	20.000.000 operations
Switching frequency	max. 5000 /h
Design of actuating element	Roller plunger
Actuating force	min. 9 N
Bounce duration	< 3 ms
Switchover time	< 5.5 ms
Positive break force	19 N
Actuating speed with actuating angle 30° to switch axis	
- Min. Actuating speed	20 mm/min
- Max. Actuating speed	1 m/s
notice	All indications about the cable section are including the conductor ferrules.

Ambient conditions

Ambient temperature	
- Min. environmental temperature	-30 °C
- Max. environmental temperature	+80 °C
Protection class	IP67

Electrical data

Design of control element	Normally open contact (NO), Opener (NC)
Switching principle	Snap switch element
- positive break NC contact 	
Number of auxiliary contacts	1 piece
Number of safety contacts	1 piece
Rated impulse withstand voltage U _{imp}	6 kV
Rated insulation voltage U _i	500 V
Thermal test current I _{the}	10 A
Utilisation category	AC-15: 230 V / 4 A, DC-13: 24 V / 1 A
Required rated short-circuit current	1000 A
Max. fuse rating	6 A gG D-fuse

Dimensions

Dimensions of the sensor

- Width of sensor	58 mm
- Height of sensor	67 mm
- Length of sensor	31 mm

Diagram

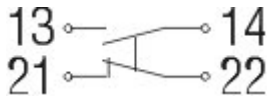

Note Diagram

- positive break NC contact
- active
- no active
- Normally-open contact
- Normally-closed contact

Switch travel diagram

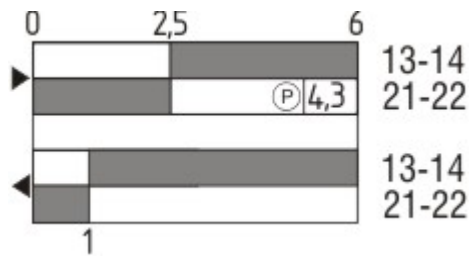

Notes Switch travel diagram

- Contact closed
- Contact open
- Setting range
- Break point
- Positive opening sequence/- angle
- VS** adjustable range of NO contact
- VÖ** adjustable range of NC contact
- N** after travel

Ordering suffix

The applicable ordering suffix is added at the end of the part number of the safety switch.

Order example: ZR 256-11z-1637

...-1637 0,3 µm gold-plated contacts

...-NPT Cable entry NPT 1/2"

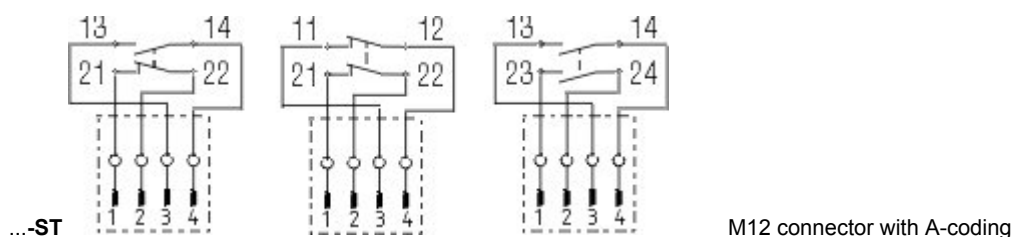

...-ST M12 connector with A-coding

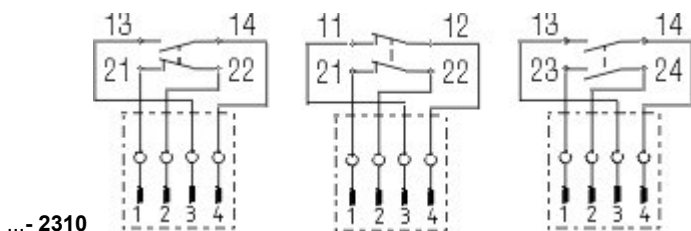

M12 connector with B-coding

...-1297

Enclosure with transverse slotted holes

Ordering code

(1)(2) 2(3)6-(4)Z(5)-(6)-(7)-(8)-(9)

(1)

Z Snap action

T Slow action

(2)

S Plunger S

R Roller plunger R

4S Plunger 4S

4R Roller plunger 4R

1R Offset roller lever 1R

K Offset roller lever K

3K Angle roller lever 3K

4K Angle roller lever 4K

K4 Angle roller lever K4

1H Roller lever 1H

7H Roller lever 7H

10H Rod lever 10H

12H Roller lever 12H

14H Roller lever 14H

AF Spring rod lever AF

(3)

3 slim design

5 large design

(4)

02 2 Opener (NC)

11 1 Normally open contact (NO) / 1 Opener (NC)

20 2 Normally open contact (NO), (Switch with 2 NO contacts are not for security tasks)

(5)

H Slow action with staggered contacts

UE Slow action with overlapping contacts

(6)

without Cable entry M20

ID IDC method of termination

NPT cable entry NPT 1/2"

ST M12 connector with A-coding

2310 M12 connector with B-coding

(7)

1297 Enclosure with transverse slotted holes

(8)

2138

Roller lever 7H for Position switches with safety function

(9)

1637

gold-plated contacts

Documents

Operating instructions and Declaration of conformity (da) 304 kB, 21.08.2013

Code: mrl_ZT235_236_da

Operating instructions and Declaration of conformity (de) 305 kB, 06.03.2014

Code: mrl_ZT235_236_de

Operating instructions and Declaration of conformity (en) 338 kB, 06.03.2014

Code: mrl_ZT235_236_en

Operating instructions and Declaration of conformity (pt) 308 kB, 21.08.2013

Code: mrl_ZT235_236_pt

Operating instructions and Declaration of conformity (es) 303 kB, 02.01.2013

Code: mrl_ZT235_236_es

Operating instructions and Declaration of conformity (it) 329 kB, 17.01.2013

Code: mrl_ZT235_236_it

Operating instructions and Declaration of conformity (fr) 306 kB, 30.04.2013

Code: mrl_ZT235_236_fr

Operating instructions and Declaration of conformity (jp) 410 kB, 14.01.2013

Code: mrl_ZT235_236_jp

Operating instructions and Declaration of conformity (nl) 296 kB, 12.04.2013

Code: mrl_ZT235_236_nl

CCC certification (cn) 324 kB, 03.02.2014

Code: q_235p02

CCC certification (en) 352 kB, 03.02.2014

Code: q_235p01

Images

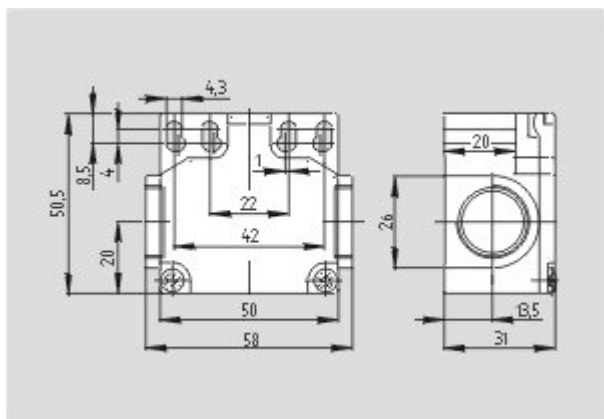

Dimensional drawing (basic component)

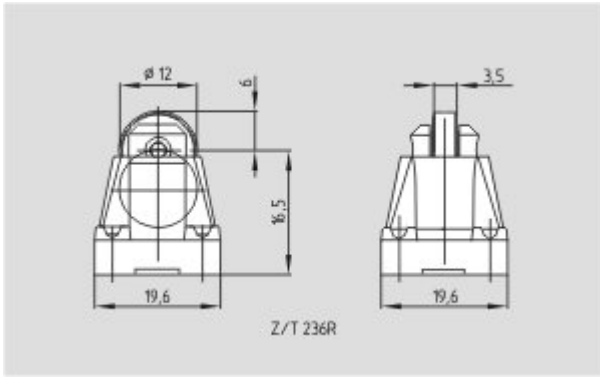

Dimensional drawing (actuator)



Operating principle

K.A. Schmersal GmbH & Co. KG, Möddinghofe 30, D-42279 Wuppertal

The data and values have been checked thoroughly. Technical modifications and errors excepted.

Generiert am 21.03.2014 - 15:56:05h Kasbase 2.2.18.F DBI

Image

Image
et=sS