

## Datasheet - Z4VH 335-11z

Position switch / 335 Metal enclosure - DIN EN 50041 with Actuator / 335 Roller lever H



Preferred typ



(Minor differences between the printed image and the original product may exist!)

- Metal enclosure
- Wide range of alternative actuators
- Good resistance to oil and petroleum spirit
- 40,5 mm x 76 mm x 38 mm
- Snap action with constant contact pressure up to switching point
- Actuator heads can be repositioned by 4 x 90°
- 1 Cable entry M 20 x 1.5
- Design to EN 50041

### Ordering details

Product type description	Z4VH 335-11Z
Article number	101154520
EAN code	4030661172712

### Approval

Approval

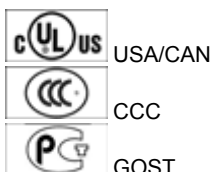

### Classification

Standards	EN ISO 13849-1
B <sub>10d</sub> Normally-closed contact (NC)	20.000.000
Mission time notice	20 Years
	$MTTF_d = \frac{B_{10d}}{0,1 \times n_{op}}$
	$n_{op} = \frac{d_{op} \times h_{op} \times 3600 \text{ s/h}}{t_{cycle}}$

### Global Properties

Product name	Z 335 Rollenschwenkhebel H
Standards	EN 60947-5-1, BG-GS-ET-15
Compliance with the Directives (Y/N) 	Yes
Suitable for safety functions (Y/N)	Yes
Actuator type	A to EN 50041
Materials	
- Material of the housings	Aluminium
- Lever material	Metal film
- Roller material	Plastic
- Material of the contacts	Silver
Housing coating	painted
Housing construction form	Norm construction design
Weight	265 g

## Mechanical data

---

Design of electrical connection	Screw connection
Cable section	
- Min. Cable section	0,75 mm <sup>2</sup>
- Max. Cable section	2.5 mm <sup>2</sup>
Mechanical life	30.000.000 operations
Switching frequency	max. 5000 /h
Design of actuating element	Roller lever
actuating torque	min. 26 Ncm
Bounce duration	in accordance with actuating speed
Switchover time	< 2 ms
Actuating speed with actuating angle 30° to switch axis	
- Min. Actuating speed	
- Max. Actuating speed	2.5 m/s
notice	All indications about the cable section are including the conductor ferrules.

## Ambient conditions

---

Ambient temperature	
- Min. environmental temperature	-30 °C
- Max. environmental temperature	+80 °C
Protection class	IP67

## Electrical data

---

Design of control element	Normally open contact (NO), Opener (NC)
Switching principle	Snap switch element
- positive break NC contact 	
Number of auxiliary contacts	1 piece
Number of safety contacts	1 piece
Rated impulse withstand voltage U <sub>imp</sub>	6 kV
Rated insulation voltage U <sub>i</sub>	500 V
Thermal test current I <sub>the</sub>	10 A
Utilisation category	AC-15: 230 V / 4 A, DC-13: 24 V / 1 A
Required rated short-circuit current	1000 A
Max. fuse rating	6 A gG D-fuse

## ATEX

Explosion protection categories for gases	None
Explosion protected category for dusts	None

## Dimensions

Dimensions of the sensor	
- Width of sensor	40.5 mm
- Height of sensor	134 mm
- Length of sensor	60.55 mm

## notice

The positioning of the head must be carried out in factory.

## Diagram

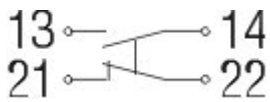

Note Diagram

- positive break NC contact
- active
- no active
- Normally-open contact
- Normally-closed contact

## Switch travel diagram

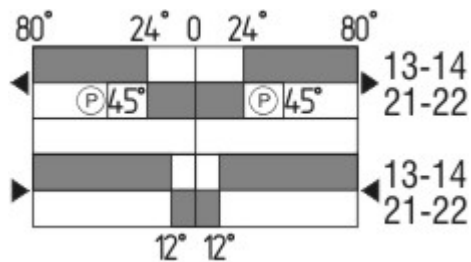

Notes Switch travel diagram

- Contact closed
- Contact open
- Setting range
- Break point
- Positive opening sequence/- angle
- VS** adjustable range of NO contact
- VÖ** adjustable range of NC contact
- N** after travel

## Ordering suffix

The applicable ordering suffix is added at the end of the part number of the safety switch.

Order example: Z4VH 335-11z-**1637**

...NPT

Cable entry NPT 1/2"

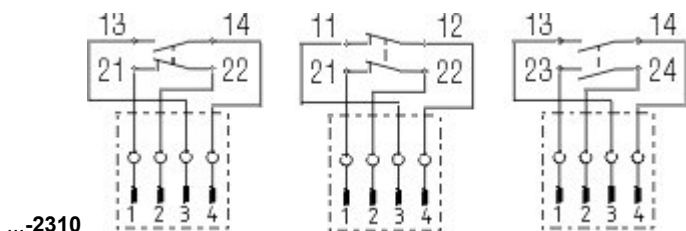

...-2310

M12 connector with B-coding  
 Rated impulse withstand voltage  $U_{imp}$ : 0,8 kV  
 Rated insulation voltage  $U_i$ : 50 V  
 Operating current  $I_e$ : AC-15: 50 V / 4 A  
 Caution! The versions with connector may only be used in PELV circuits to EN 60204-1.

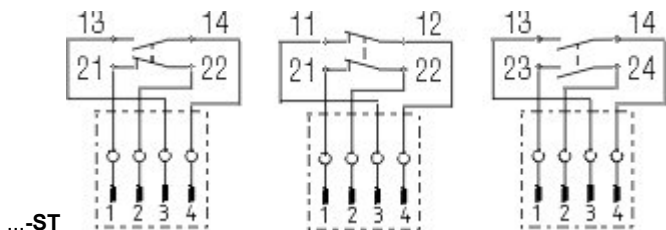

...-ST

M12 connector with A-coding  
 Rated impulse withstand voltage  $U_{imp}$ : 0,8 kV  
 Rated insulation voltage  $U_i$ : 50 V  
 Operating current  $I_e$ : AC-15: 50 V / 4 A  
 Caution! The versions with connector may only be used in PELV circuits to EN 60204-1.

...-RMS

Available with metal roller

...-1H

Roller material : Plastic  
 Durchmesser : 25 mm

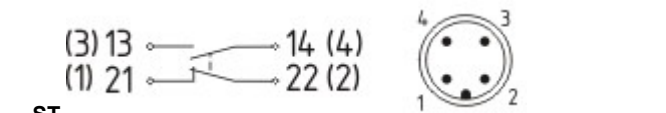

...-ST

M12 connector with A-coding  
 Rated impulse withstand voltage  $U_{imp}$ : 0,8 kV  
 Rated insulation voltage  $U_i$ : 50 V  
 Operating current  $I_e$ : AC-15: 50 V / 4 A  
 Caution! The versions with connector may only be used in PELV circuits to EN 60204-1.

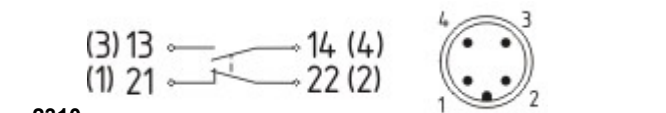

...-2310

M12 connector with B-coding  
 Rated impulse withstand voltage  $U_{imp}$ : 0,8 kV  
 Rated insulation voltage  $U_i$ : 50 V  
 Operating current  $I_e$ : AC-15: 50 V / 4 A  
 Caution! The versions with connector may only be used in PELV circuits to EN 60204-1.

### Ordering code

(1)(2) 3(3)5-(4)Z(5)-(6)-(7)-(8)-(9)

- (1)
- Z Snap action
- T Slow action
- (2)
- S Plunger S
- R Roller plunger R
- H Roller lever H
- 10H Rod lever 10H
- 7H Roller lever 7H
- 1K Offset roller lever 1K
- 3K Angle roller lever 3K
- (3)
- 3 slim design

5	large design
(4)	
11	1 Normally open contact (NO) / 1 Opener (NC)
02	2 Opener (NC)
20	2 Normally open contact (NO) ( <i>Switch with 2 NO contacts are not for security tasks</i> )
01/01	1 Opener (NC) left / 1 Opener (NC) right
12	1 Normally open contact (NO) / 2 Opener (NC)
03	3 Opener (NC)
(5)	
H	Slow action with staggered contacts
UE	Slow action with overlapping contacts
(6)	
G24	with LED
(7)	
without	Cable entry M20
NPT	cable entry NPT 1/2"
ST	M12 connector with A-coding ( <i>Caution! The versions with connector may only be used in PELV circuits to EN 60204-1.</i> )
2310	M12 connector with B-coding ( <i>Caution! The versions with connector may only be used in PELV circuits to EN 60204-1.</i> )
(8)	
2138	Roller lever 7H for Position switches with safety function
(9)	
1637	gold-plated contacts

## Documents

---

**Operating instructions and Declaration of conformity** (de) 310 kB, 03.04.2013

Code: mrl\_zt332-335-336-355\_de

**Operating instructions and Declaration of conformity** (it) 308 kB, 04.04.2013

Code: mrl\_zt332-335-336-355\_it

**Operating instructions and Declaration of conformity** (fr) 325 kB, 04.04.2013

Code: mrl\_zt332-335-336-355\_fr

**Operating instructions and Declaration of conformity** (cn) 797 kB, 02.03.2010

Code: mrl\_zt332-335-336-355\_cn

**Operating instructions and Declaration of conformity** (nl) 321 kB, 04.04.2013

Code: mrl\_zt332-335-336-355\_nl

**Operating instructions and Declaration of conformity** (jp) 1 MB, 22.11.2010

Code: mrl\_zt332-335-336-355\_jp

**Operating instructions and Declaration of conformity** (pt) 327 kB, 04.04.2013

Code: mrl\_zt332-335-336-355\_pt

**Operating instructions and Declaration of conformity** (es) 323 kB, 04.04.2013

Code: mrl\_zt332-335-336-355\_es

**Operating instructions and Declaration of conformity** (da) 323 kB, 04.04.2013

Code: mrl\_zt332-335-336-355\_da

**Operating instructions and Declaration of conformity** (en) 337 kB, 03.04.2013

Code: mrl\_zt332-335-336-355\_en

**Operating instructions and Declaration of conformity** (pl) 358 kB, 04.04.2013

Code: mrl\_zt332-335-336-355\_pl

**CCC certification** (en) 317 kB, 04.02.2014

Code: q\_347p02

**CCC certification** (cn) 315 kB, 04.02.2014

Code: q\_347p03

**Gost certification** (ru) 2 MB, 07.07.2011

Code: q\_az1p01

## Images

---

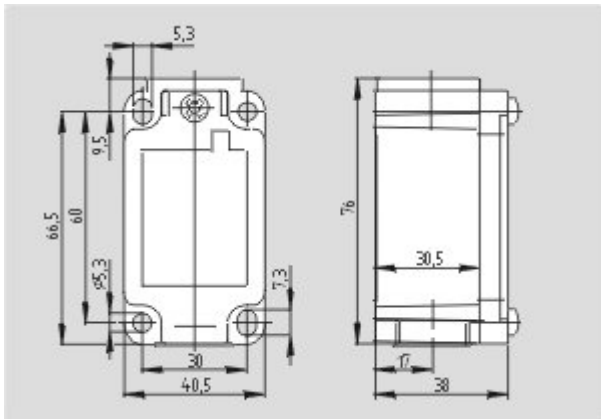

Dimensional drawing (basic component)

---

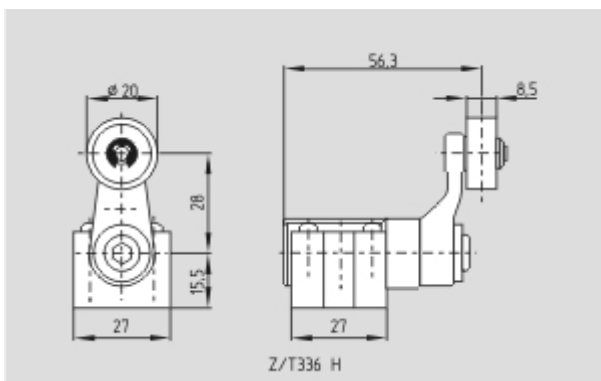

Dimensional drawing (actuator)

---

K.A. Schmersal GmbH & Co. KG, Möddinghofe 30, D-42279 Wuppertal

The data and values have been checked thoroughly. Technical modifications and errors excepted.

Generiert am 21.03.2014 - 15:05:41h Kasbase 2.2.18.F DBI

Image

Image  
et=sS