

## Datasheet - AZM 170-02ZRKA-ST 24 VAC/DC

Solenoid interlock / AZM 170



Preferred typ



- thermoplastic enclosure
- Double-insulated
- Compact design
- 90 mm x 84 mm x 30 mm
- Interlock with protection against incorrect locking.
- Long life
- High holding force
- Connector M12, 4-pole
- Manual release

(Minor differences between the printed image and the original product may exist!)

### Ordering details

Product type description	AZM 170-02ZRKA-ST 24 VAC/DC
Article number	101141422
EAN code	4030661121888

### Approval

Approval

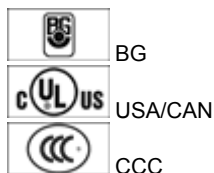

### Classification

Standards	EN ISO 13849-1
B <sub>10d</sub> Opener (NC)	2.000.000
Mission time	20 Years
notice	$MTTF_d = \frac{B_{10d}}{0,1 \times n_{op}}$ $n_{op} = \frac{d_{op} \times h_{op} \times 3600 \text{ s/h}}{t_{cycle}}$

### Global Properties

Product name	AZM 170
Standards	EN 60947-5-1, BG-GS-ET-19

Compliance with the Directives (Y/N) 	Yes
Number of actuating directions	2 piece
Active principle	electromechanical
Duty cycle	Magnet 100 %
Materials	
- Material of the housings	Plastic, glass-fibre reinforced thermoplastic, self-extinguishing
- Material of the contacts	Silver
Housing coating	None
Weight	275 g

### Mechanical data

---

Design of electrical connection	Connector M12
Mechanical life	> 1.000.000 operations
Emergency unlocking device (Y/N)	No
Manual release (Y/N)	Yes
- bottom	
Emergency release (Y/N)	No
Latching force	30 N
Positive break force	17 N
positive break travel	11 mm
Clamping force $F_{max}$	1000 N
Max. Actuating speed	2 m/s

### Ambient conditions

---

Ambient temperature	
- Min. environmental temperature	-25 °C
- Max. environmental temperature	+60 °C
Protection class	IP67 to IEC/EN 60529

### Electrical data

---

Design of control element	Opener (NC)
Switching principle	Creep circuit element
Number of auxiliary contacts	0 piece
Number of safety contacts	2 piece
Power to unlock	No
Power to lock	Yes
Rated control voltage $U_s$	24 VAC/DC
Power consumption	max. 10 W
Rated impulse withstand voltage $U_{imp}$	4 kV
Rated insulation voltage $U_i$	250 V
Thermal test current $I_{the}$	10 A
Utilisation category	AC-15: 230 V / 4 A, DC-13: 24 V / 4 A
Max. fuse rating	6 A gG D-fuse



### ATEX

---

Explosion protection categories for gases	None
Explosion protected category for dusts	None

### Miscellaneous data

Applications

-  sliding safety guard,
-  removable guard,
-  hinged safety guard

Dimensions

Dimensions of the sensor

- Width of sensor 90 mm
- Height of sensor 75.5 mm
- Length of sensor 30 mm

notice

Individual coding available on request



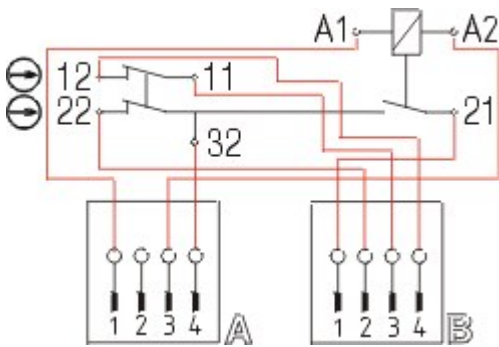

Manual release

- For manual release using M5 triangular key, available as accessory

Diagram





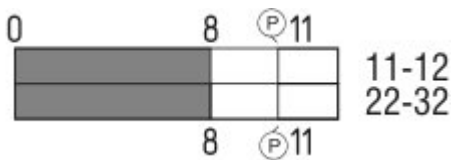

Note Diagram

-  positive break NC contact
-  active
-  no active
-  Normally-open contact
-  Normally-closed contact

Switch travel diagram



Notes Switch travel diagram

-  Contact closed
-  Contact open
-  Setting range
-  Break point
-  Positive opening sequence/- angle
- VS** adjustable range of NO contact

VÖ adjustable range of NC contact  
N after travel

## Ordering suffix

---

The applicable ordering suffix is added at the end of the part number of the safety switch.  
Order example: AZM 170-02ZRKA-ST 24 VAC/DC-**1637**

---

...- <b>1637</b>	0,3 µm gold-plated contacts
... <b>ST-2431</b>	connector M12 , Individual solenoid monitoring

---

## Ordering code

---

AZM 170(1)-(2)Z(3)K(4)-(5)-(6)-(7)

(1)	
without	IDC method of termination
<b>SK</b>	Screw connection
(2)	
<b>11</b>	1 Normally open contact (NO) / 1 Opener (NC)
<b>02</b>	2 Opener (NC)
<b>12/0.0</b>	1 Normally open contact (NO), 2 Opener (NC) / -
(3)	
without	Latching force 5 N
<b>R</b>	Latching force 30 N
<b>I</b>	Individual coding
(4)	
without	Power to unlock
<b>A</b>	Power to lock
(5)	
without	cable gland
<b>ST</b>	Connector M12 x 1
<b>ST-2431</b>	Connector M12 x 1, Individual solenoid monitoring
(6)	
<b>24VAC/DC</b>	U <sub>s</sub> 24 VAC/DC
<b>110VAC</b>	U <sub>s</sub> 110 VAC
<b>230VAC</b>	U <sub>s</sub> 230 VAC
(7)	
without	Manual release
<b>2197</b>	Manual release from side (Power to unlock)
<b>1637</b>	gold-plated contacts

### AZM 170ST and AZM 170SK

**AZM 170ST-(1)Z(2)K(3)-(4)-(5)-024**

**AZM 170SK-(1)Z(2)K(3)-(4)-(5)-024**

(1)	
<b>11/11</b>	1 Normally open contact (NO), 1 Opener (NC) / 1 Normally open contact (NO), 1 Opener (NC)
<b>11/02</b>	1 Normally open contact (NO), 1 Opener (NC) / 2 Opener (NC)
<b>12/00</b>	1 Normally open contact (NO), 2 Opener (NC) / -
<b>12/11</b>	1 Normally open contact (NO), 2 Opener (NC) / 1 Normally open contact

	(NO), 1 Opener (NC)
<b>12/02</b>	1 Normally open contact (NO), 2 Opener (NC) / 2 Opener (NC)
<b>02/01</b>	2 Opener (NC), - / 1 Opener (NC), -
<b>02/10</b>	2 Opener (NC), - / 1 Normally open contact (NO), -
<b>(2)</b>	
<i>without</i>	Latching force 5 N
<b>R</b>	Latching force 30 N
<b>(3)</b>	
<i>without</i>	Power to unlock
<b>A</b>	Power to lock
<b>(4)</b>	
<b>1637</b>	gold-plated contacts
<b>(5)</b>	
<b>2197</b>	Manual release for Power to unlock

## Documents

---

**Operating instructions and Declaration of conformity** (fr) 670 kB, 01.07.2010

Code: mrl\_azm170\_fr

**Operating instructions and Declaration of conformity** (de) 923 kB, 24.02.2011

Code: mrl\_azm170\_de

**Operating instructions and Declaration of conformity** (it) 645 kB, 09.04.2010

Code: mrl\_azm170\_it

**Operating instructions and Declaration of conformity** (nl) 720 kB, 23.09.2010

Code: mrl\_azm170\_nl

**Operating instructions and Declaration of conformity** (en) 746 kB, 12.03.2010

Code: mrl\_azm170\_en

**Operating instructions and Declaration of conformity** (jp) 709 kB, 14.04.2011

Code: mrl\_azm170\_jp

**Operating instructions and Declaration of conformity** (pl) 576 kB, 11.07.2013

Code: mrl\_azm170\_pl

**Operating instructions and Declaration of conformity** (da) 582 kB, 07.08.2012

Code: mrl\_azm170\_da

**Operating instructions and Declaration of conformity** (es) 665 kB, 25.03.2010

Code: mrl\_azm170\_es

**BG-test certificate** (en) 236 kB, 10.12.2013

Code: z\_m17p02

**BG-test certificate** (de) 238 kB, 10.12.2013

Code: z\_m17p01

**CCC certification** (en) 469 kB, 21.09.2012

Code: q\_371p02

**CCC certification** (cn) 470 kB, 21.09.2012

Code: q\_371p03

Gost certification (ru) 2 MB, 07.07.2011

Code: q\_az1p01

## Images

---



Product photo

---

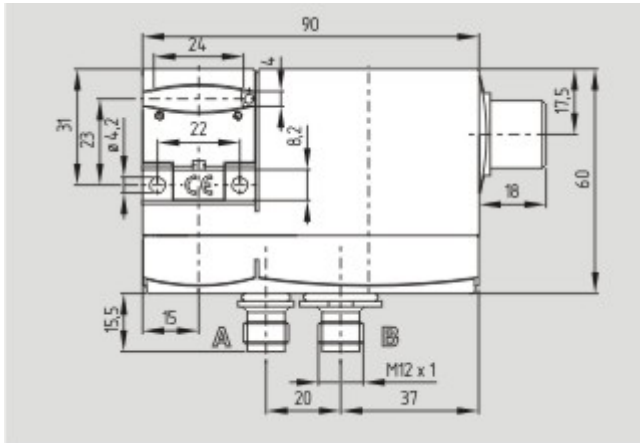

Dimensional drawing (basic component)

---

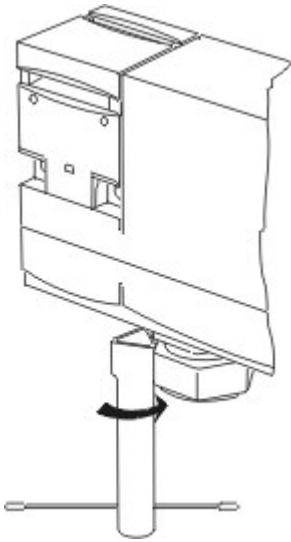

Detail photo

---

## System components

---

### Actuator



**101122893 - AZ 17/170-B1**

- Particularly suitable for sliding doors



**1137406 - AZ 17/170-B1-2245**

- Damps vibration on guard device



**1122895 - AZ 17/170-B5**

- Particularly suitable for hinged guards (front mounting)



**1139788 - AZ 17/170-B11**

- Particularly suitable for sliding doors



**1139789 - AZ 17/170-B15**

- Particularly suitable for hinged guards (front mounting)



#### 101123391 - AZM 170-B6

- For very small actuating radii
- The direction of actuation can be selected by applicable insertion of the insert

---

### Accessories



#### 1208493 - AZM 170-B CENTERING GUIDE

- for AZ 17 and AZM 170



#### 101100887 - TRIANGULAR KEY M5

- For manual release using M5 triangular key, available as accessory
- For maintenance, installation, etc.

---

### Connector



#### A-K4M12

- Pre-wired cable
- 4-pole



#### S-K4M12

- Connector without cable
- 4-pole



#### A-K4M12

- Pre-wired cable
- 4-pole



#### S-K4M12

- Connector without cable
- 4-pole



Image

Image  
et=sS  
e