

Datasheet - AZ 17-11ZRK-ST

Safety switch with separate actuator / AZ 17



Preferred typ



- thermoplastic enclosure
- Small body
- 8 actuating planes
- 30 mm x 60 mm x 30 mm
- Multiple coding
- Double-insulated
- Long life
- High level of contact reliability with low voltages and currents
- Not sensitive to dirty conditions by virtue of patented roller system
- Connector M12 x 1, 4-pole

(Minor differences between the printed image and the original product may exist!)

Ordering details

Product type description	AZ 17-11ZRK-ST
Article number	101140774
EAN code	4030661119731

Approval

Approval

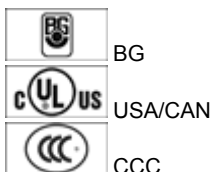

Classification

Standards	EN ISO 13849-1
B _{10d} Opener (NC)	2.000.000
B _{10d} Normally open contact (NO)	1.000.000
- notice	at 10% I _e and ohmic load
Mission time	20 Years
notice	$MTTF_d = \frac{B_{10d}}{0,1 \times n_{op}}$

$$n_{op} = \frac{d_{op} \times h_{op} \times 3600 \text{ s/h}}{t_{cycle}}$$

Global Properties

Product name	AZ 17
Standards	EN 60947-5-1, BG-GS-ET-15
Materials	
- Material of the housings	Plastic, glass-fibre reinforced thermoplastic, self-extinguishing
- Material of the contacts	Silver
Housing coating	None
Weight	85 g

Mechanical data

Design of electrical connection	Connector M12
Mechanical life	> 1.000.000 operations
higher Latching force (Y/N)	Yes
Latching force	30 N
Positive break force	17 N
positive break travel	11 mm
Max. Actuating speed	2 m/s

Ambient conditions

Protection class	IP67 to IEC/EN 60529
------------------	----------------------

Electrical data

Design of control element	Normally open contact (NO), Opener (NC)
Switching principle	Creep circuit element
Number of auxiliary contacts	1 piece
Number of safety contacts	1 piece
Rated impulse withstand voltage U_{imp}	4 kV
Rated insulation voltage U_i	250 V
Thermal test current I_{the}	10 A
Utilisation category	AC-15: 230 V / 4 A DC-13: 24 V / 4 A
Max. fuse rating	6 A gG D-fuse

ATEX

Explosion protection categories for gases	None
Explosion protected category for dusts	None

Dimensions

Dimensions of the sensor	
- Width of sensor	30 mm
- Height of sensor	80.5 mm
- Length of sensor	30 mm

notice

Individual coding available on request

Included in delivery



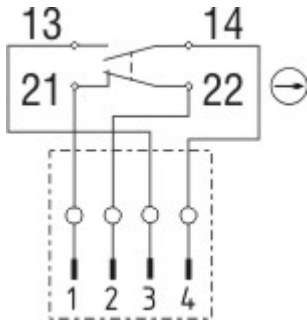

Actuators must be ordered separately.

Slot sealing plugs

Diagram





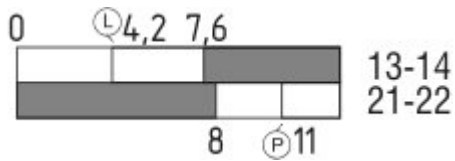

Note Diagram

-  positive break NC contact
-  active
-  no active
-  Normally-open contact
-  Normally-closed contact

Switch travel diagram



Notes Switch travel diagram

-  Contact closed
 -  Contact open
 -  Setting range
 -  Break point
 -  Positive opening sequence/- angle
- VS** adjustable range of NO contact
VÖ adjustable range of NC contact
N after travel

Ordering code

AZ 17-(1)Z(2)K-(3)-(4)-(5)

<p>(1)</p> <p>11</p> <p>02</p> <p>(2)</p> <p>without</p> <p>R</p> <p>(3)</p> <p>without</p> <p>2243</p>	<p>Normally open contact (NO) 1 / Opener (NC) 1</p> <p>Opener (NC) 2</p> <p>Latching force 5 N</p> <p>Latching force 30 N</p> <p>cable gland M16</p> <p>Front cable entry</p>
---	---

2243-1	Rear cable entry
ST	Connector M12, 4-pole
(4)	
1637	gold-plated contacts
(5)	
5M	5 m Cable length
6M	6 m Cable length

Documents

Operating instructions and Declaration of conformity (pl) 490 kB, 18.11.2013

Code: mrl_az17_pl

Operating instructions and Declaration of conformity (ro) 511 kB, 25.01.2012

Code: mrl_az17_ro

Operating instructions and Declaration of conformity (sv) 509 kB, 04.01.2012

Code: mrl_az17_sv

Operating instructions and Declaration of conformity (jp) 1 MB, 17.11.2010

Code: mrl_az17_jp

Operating instructions and Declaration of conformity (it) 476 kB, 02.07.2013

Code: mrl_az17_it

Operating instructions and Declaration of conformity (da) 510 kB, 25.01.2012

Code: mrl_az17_da

Operating instructions and Declaration of conformity (br) 650 kB, 07.07.2010

Code: mrl_az17-ace_br

Operating instructions and Declaration of conformity (es) 477 kB, 19.08.2013

Code: mrl_az17_es

Operating instructions and Declaration of conformity (de) 476 kB, 28.05.2013

Code: mrl_az17_de

Operating instructions and Declaration of conformity (en) 475 kB, 10.04.2013

Code: mrl_az17_en

Operating instructions and Declaration of conformity (fr) 479 kB, 29.07.2013

Code: mrl_az17_fr

Operating instructions and Declaration of conformity (nl) 479 kB, 02.07.2013

Code: mrl_az17_nl

Operating instructions and Declaration of conformity (pt) 857 kB, 22.11.2011

Code: mrl_az17_pt

Operating instructions and Declaration of conformity (cs) 511 kB, 27.02.2012

Code: mrl_az17_cs

BG-test certificate (en) 578 kB, 15.08.2011

Code: z_z17p02

BG-test certificate (de) 589 kB, 15.08.2011

Code: z_z17p01

CCC certification (en) 1 MB, 19.05.2011

Code: q_175p02

CCC certification (cn) 1 MB, 19.05.2011

Code: q_175p03

Gost certification (ru) 2 MB, 07.07.2011

Code: q_az1p01

Images

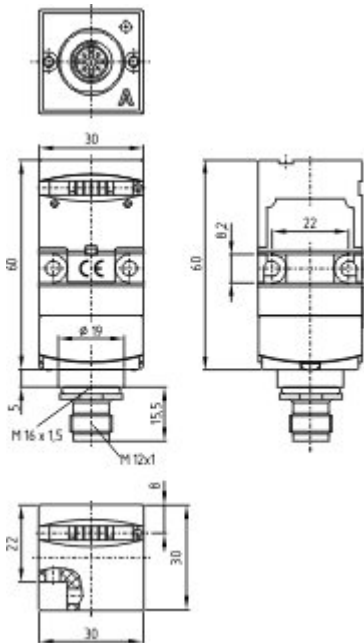

Dimensional drawing (basic component)

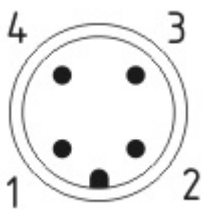

Contact arrangement

System components

Actuator



101122893 - AZ 17/170-B1

- Particularly suitable for sliding doors
-



101137406 - AZ 17/170-B1-2245

- Damps vibration on guard device



101122895 - AZ 17/170-B5

- Particularly suitable for hinged guards (front mounting)



101126060 - AZ 17-B6

- For very small actuating radii
- The direction of actuation can be selected by applicable insertion of the insert



101139788 - AZ 17/170-B11

- Particularly suitable for sliding doors



101139789 - AZ 17/170-B15

- Particularly suitable for hinged guards (front mounting)

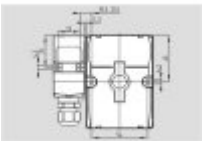

AZ 17-B25

- Ergonomic operation
- No supplementary door-handle required
- Door hinge on left-hand side (View point towards the hazardous area)
- No protruding actuator
- Actuator without handle
- Simple mounting
- Several door-handles available
- Possibility to mount the own handles using a default square screw (8 mm)

Accessories

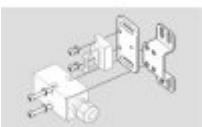

101150363 - Mounting set MS AZ 17 P

101149212 - Mounting set MS AZ 17 R/P

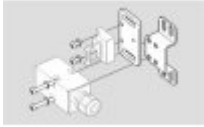

101208493 - AZM 170-B CENTERING GUIDE

- for AZ 17 and AZM 170

Connector



A-K4M12

- Pre-wired cable
- 4-pole



S-K4M12

- Connector without cable
- 4-pole

Mounting accessories



1135338 - TAMPERPROOF SCREWS M 5 x 12

- To mount the actuator
- Higher protection against tampering with interlock
- Protects against unauthorised removal of actuator
- Various lengths available



101135339 - TAMPERPROOF SCREWS M 5 x 16

- To mount the actuator
- Higher protection against tampering with interlock
- Protects against unauthorised removal of actuator
- Various lengths available



101135340 - TAMPERPROOF SCREWS M 5 x 20

- To mount the actuator
- Higher protection against tampering with interlock
- Protects against unauthorised removal of actuator
- Various lengths available

Image

Image
et=sS
e