

## Datasheet - AZ 16-02ZVRK

Safety switch with separate actuator / AZ 16



Preferred typ



(Minor differences between the printed image and the original product may exist!)

- thermoplastic enclosure
- Double-insulated 
- Large wiring compartment
- 52 mm x 90 mm x 30 mm
- Multiple coding
- Long life
- High level of contact reliability with low voltages and currents
- Slotted holes for adjustment, circular holes for location
- 3 cable entries M 16 x 1.5

### Ordering details

Product type description	AZ 16-02ZVRK
Article number	101147145
EAN code	4030661141671

### Approval

Approval

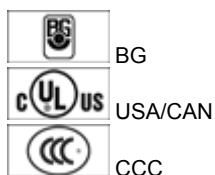

### Classification

Standards	EN ISO 13849-1
B <sub>10d</sub> Opener (NC)	2.000.000
Mission time notice	20 Years
	$MTTF_d = \frac{B_{10d}}{0,1 \times n_{op}}$
	$n_{op} = \frac{d_{op} \times h_{op} \times 3600 \text{ s/h}}{t_{cycle}}$

### Global Properties

Product name	AZ 16
Standards	EN 60947-5-1, BG-GS-ET-15

Compliance with the Directives (Y/N) 

Yes

#### Materials

- Material of the housings
- Material of the contacts

Plastic, glass-fibre reinforced thermoplastic, self-extinguishing

Silver

Housing coating

None

Weight

115 g

### Mechanical data

---

Design of electrical connection

Screw connection

Cable section

- Min. Cable section
- Max. Cable section

0,75 mm<sup>2</sup>

2.5 mm<sup>2</sup>

Mechanical life

> 1.000.000 operations

higher Latching force (Y/N)

Yes

Latching force

30 N

With ejection force (Y/N)

No

Positive break force

20 N

positive break travel

8 mm

Actuating speed

max. 2 m/s

notice

All indications about the cable section are including the conductor ferrules.

### Ambient conditions

---

Ambient temperature

- Min. environmental temperature
- Max. environmental temperature

-30 °C

+80 °C

Protection class

IP67 to IEC/EN 60529

### Electrical data

---

Design of control element

Opener (NC)

Switching principle

Creep circuit element

Number of auxiliary contacts

0 piece

Number of safety contacts

2 piece

Rated impulse withstand voltage  $U_{imp}$

6 kV

Rated insulation voltage  $U_i$

500 V

Thermal test current  $I_{the}$

10 A

Utilisation category

AC-15: 230 V / 4 A,  
DC-13: 24 V / 4 A

Max. fuse rating

6 A gG D-fuse

### ATEX

---

Explosion protection categories for gases

None

Explosion protected category for dusts

None

### Dimensions

---

Dimensions of the sensor

- Width of sensor
- Height of sensor
- Length of sensor

52 mm

90 mm

30 mm

## Included in delivery

Actuators must be ordered separately.

## Diagram

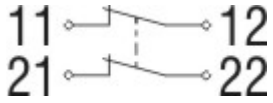

Note Diagram

- positive break NC contact
- active
- no active
- Normally-open contact
- Normally-closed contact

## Switch travel diagram

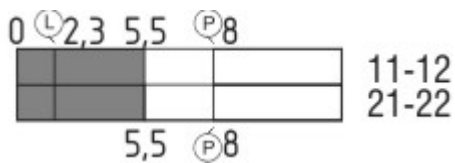

Notes Switch travel diagram

- Contact closed
  - Contact open
  - Setting range
  - Break point
  - Positive opening sequence/- angle
- VS** adjustable range of NO contact  
**VÖ** adjustable range of NC contact  
**N** after travel

## Ordering suffix

The applicable ordering suffix is added at the end of the part number of the safety switch.

Order example: AZ 16-02ZVRK-2254

...-2254 Latching force 5 N

...-M20 cable entries M20

## Ordering code

AZ 16-(1)ZV(2)K-(3)-(4)-(5)

- (1)  
without 1 Normally open contact (NO) / 1 Opener (NC)
- 02 2 Opener (NC)
- 03 3 Opener (NC)
- 12 Normally open contact (NO) 1 / Opener (NC) 2
- (2)

<i>without</i>	Ejection force
<b>R</b>	Latching force 30 N
<b>(3)</b>	
<b>G24</b>	with LED ( <i>only available for version with one NO and one NC contact.</i> )
<b>(4)</b>	
<i>without</i>	Cable entry M16
<b>M20</b>	Cable entry M20
<b>ST</b>	Connector M12, 4-pole, bottom
<b>STL</b>	Connector M12, 4-pole, left
<b>STR</b>	Connector M12, 4-pole, right
<b>(5)</b>	
<b>2254</b>	Latching force 5 N
<b>1762</b>	Front mounting
<b>1637</b>	gold-plated contacts

## Documents

---

**Operating instructions and Declaration of conformity** (br) 436 kB, 26.05.2010

Code: mrl\_az15-16\_br

**Operating instructions and Declaration of conformity** (pt) 268 kB, 21.08.2013

Code: mrl\_az15-16\_pt

**Operating instructions and Declaration of conformity** (pt) 433 kB, 25.05.2010

Code: mrl\_az15-16\_pt

**Operating instructions and Declaration of conformity** (de) 248 kB, 28.05.2013

Code: mrl\_az15-16\_de

**Operating instructions and Declaration of conformity** (fr) 268 kB, 29.07.2013

Code: mrl\_az15-16\_fr

**Operating instructions and Declaration of conformity** (jp) 374 kB, 10.07.2013

Code: mrl\_az15-16\_jp

**Operating instructions and Declaration of conformity** (cs) 400 kB, 11.10.2011

Code: mrl\_az15-16\_cs

**Operating instructions and Declaration of conformity** (es) 266 kB, 30.07.2013

Code: mrl\_az15-16\_es

**Operating instructions and Declaration of conformity** (pl) 298 kB, 02.07.2013

Code: mrl\_az15-16\_pl

**Operating instructions and Declaration of conformity** (sv) 462 kB, 25.10.2011

Code: mrl\_az15-16\_sv

**Operating instructions and Declaration of conformity** (da) 398 kB, 17.11.2011

Code: mrl\_az15-16\_da

**Operating instructions and Declaration of conformity** (en) 260 kB, 28.05.2013

Code: mrl\_az15-16\_en

**Operating instructions and Declaration of conformity** (ro) 400 kB, 18.11.2011

Code: mrl\_az15-16\_ro

**Operating instructions and Declaration of conformity** (nl) 266 kB, 02.07.2013

Code: mrl\_az15-16\_nl

**Operating instructions and Declaration of conformity** (it) 261 kB, 02.07.2013

Code: mrl\_az15-16\_it

**Mounting and wiring instructions** (de, en, fr, it, es, jp) 181 kB, 12.06.2007

Code: m\_mazp01

**BG-test certificate** (en) 197 kB, 01.06.2010

Code: z\_z15p02

**BG-test certificate** (de) 198 kB, 01.06.2010

Code: z\_z15p01

**CCC certification** (en) 1 MB, 19.05.2011

Code: q\_175p02

**CCC certification** (cn) 1 MB, 19.05.2011

Code: q\_175p03

**Gost certification** (ru) 2 MB, 07.07.2011

Code: q\_az1p01

## Images

---

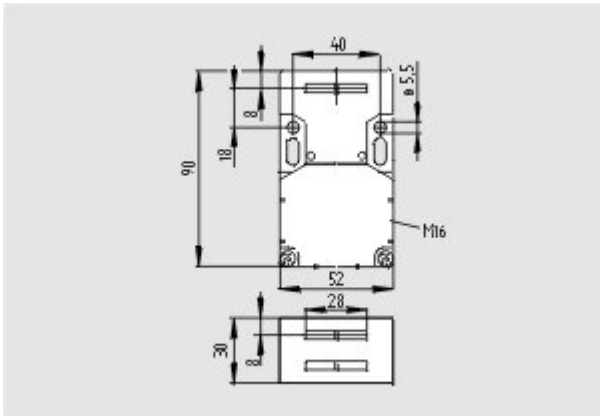

Dimensional drawing (basic component)

---

## System components

---

### Actuator

101083036 - AZ 15/16-B1



---

101092711 - AZ 15/16-B1-1747



- For play-free interlocking of light guards
- Suitable for retrofitting



**101093553 - AZ 15/16-B1-1747**

- For play-free interlocking of light guards
- The magnetic latch can be easily fitted in any actuating plane
- Suitable for retrofitting



**101108276 - AZ 15/16-B1-2024**



**101108278 - AZ 15/16-B1-2024 WITH SLOT SEALING PLUG**

- For protection against the ingress of course dirt



**101111079 - AZ 15/16-B1-2053**

- For interlocking of light to medium-weight guards



**101111081 - AZ 15/16-B1-2053 WITH BALL LATCH**

- For interlocking of light to medium-weight guards



**101126793 - AZ 15/16-B1-2177**

- For interlocking of light, unguided guards



**101126794 - AZ 15/16-B1-2177 WITH CENTERING GUIDE**

- For interlocking of light, unguided guards



**101137408 - AZ 15/16-B1-2245**

- Damps vibration on guard device



**101095558 - AZ 15/16-B2**

- For very small actuating radii in line with the plane of the actuator



**101096091 - AZ 15/16-B2-1747**

- For very small actuating radii in line with the plane of the actuator
- Suitable for retrofitting
- For play-free interlocking of light guards



**101096089 - AZ 15/16-B2-1747 WITH MAGNETIC LATCH**

- For very small actuating radii in line with the plane of the actuator
- Suitable for retrofitting
- For play-free interlocking of light guards
- The magnetic latch can be easily fitted in any actuating plane



**101095550 - AZ 15/16-B3**

- For very small actuating radii at 90° to the plane of the actuator



**101096090 - AZ 15/16-B3-1747 WITH MAGNETIC LATCH**

- For very small actuating radii at 90° to the plane of the actuator
- Suitable for retrofitting
- For play-free interlocking of light guards
- The magnetic latch can be easily fitted in any actuating plane



**101096092 - AZ 15/16-B3-1747**

- For very small actuating radii at 90° to the plane of the actuator
- Suitable for retrofitting
- For play-free interlocking of light guards

---

**101137434 - AZ 15/16-B6**

- For very small actuating radii in line with or at 90° to the plane of the actuator



---

## Door-handle system



### AZ 16-STS30

- Latching handle
- Suitable for all types of guard

---

## Accessories

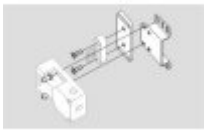

### 101149214 - Mounting set MS AZ 15/16 R/P

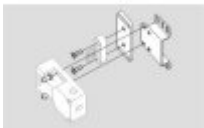

### 101150373 - Mounting set MS AZ 15/16 P



### 101089116 - Slot sealing plugs AZ 15/16-1476

- For protection against the ingress of course dirt
- To cover unused actuator slots
- Simple clip-in fitting



### 101115025 - Ball latch 2053-2

- Additional ball latch for stable latching of light to medium-weight guards
- For separate mounting on the guard



### 101110500 - SZ 16/335

- To prevent inadvertent closing, e.g. during maintenance
- For complex plant
- Prevents actuation of the switch
- Up to 6 padlocks can be fitted
- The lockout tag can be mounted on a chain near to the safety switch

---

## Mounting accessories

### 1135338 - TAMPERPROOF SCREWS M 5 x 12





- To mount the actuator
- Higher protection against tampering with interlock
- Protects against unauthorised removal of actuator
- Various lengths available



---

**101135339 - TAMPERPROOF SCREWS M 5 x 16**

- To mount the actuator
- Higher protection against tampering with interlock
- Protects against unauthorised removal of actuator
- Various lengths available



---

**101135340 - TAMPERPROOF SCREWS M 5 x 20**

- To mount the actuator
- Higher protection against tampering with interlock
- Protects against unauthorised removal of actuator
- Various lengths available

---

K.A. Schmersal GmbH & Co. KG, Möddinghofe 30, D-42279 Wuppertal

The data and values have been checked thoroughly. Technical modifications and errors excepted.

Generiert am 05.03.2014 - 13:22:21h Kasbase 2.2.18.F DBI

Image

Image  
et=sS  
e