

Electronic housing - UM108-FE - 2959463

Please be informed that the data shown in this PDF Document is generated from our Online Catalog. Please find the complete data in the user's documentation. Our General Terms of Use for Downloads are valid (<http://download.phoenixcontact.com>)

Foot element, 107.5 mm wide, for mounting on NS 32 or NS 35/7.5, below profile housing UM 108.



Product Features

- Lateral elements with potential ground contact available from the PCB to the DIN rail (EMC)
- Fast assembly on standard NS 35 or NS 32 DIN rails
- Flexible size and shape
- Inexpensive as a result of reducing the number of separate housing parts
- Wide range of options for external conductor connection
- High degree of mechanical stability by screwing the lateral elements to the profile
- The modules can be marked with Phoenix Contact marking material using the marking grooves in the press-drawn section

Key commercial data

package_quantity	10
GTIN	4017918086121

classifications

eCl@ss

eCl@ss 4.0	27180401
eCl@ss 4.1	27180401
eCl@ss 5.0	27180506
eCl@ss 5.1	27180506
eCl@ss 6.0	27180802
eCl@ss 7.0	27182701
eCl@ss 8.0	27182701

ETIM

ETIM 2.0	EC001031
ETIM 3.0	EC001031
ETIM 4.0	EC001031
ETIM 5.0	EC002779

UNSPSC

UNSPSC 6.01	31261501
UNSPSC 7.0901	31261501
UNSPSC 11	31261501

Electronic housing - UM108-FE - 2959463

classifications

UNSPSC

UNSPSC 12.01	31261501
UNSPSC 13.2	31261501

approvals

UL Recognized /

Approval details



Drawings

Dimensioned drawing

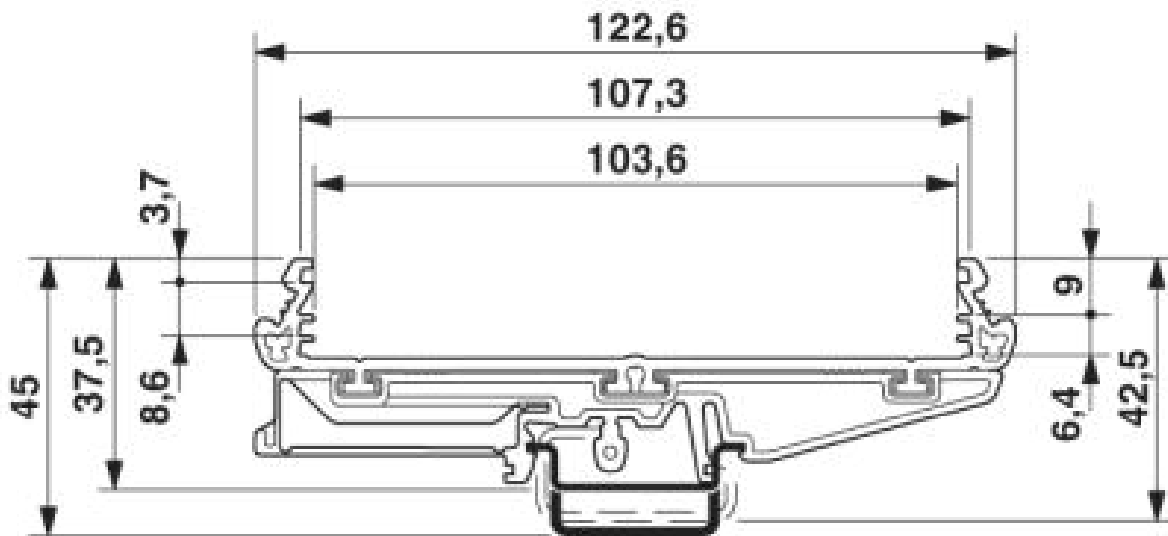

Electronic housing - UM108-FE - 2959463

Dimensioned drawing

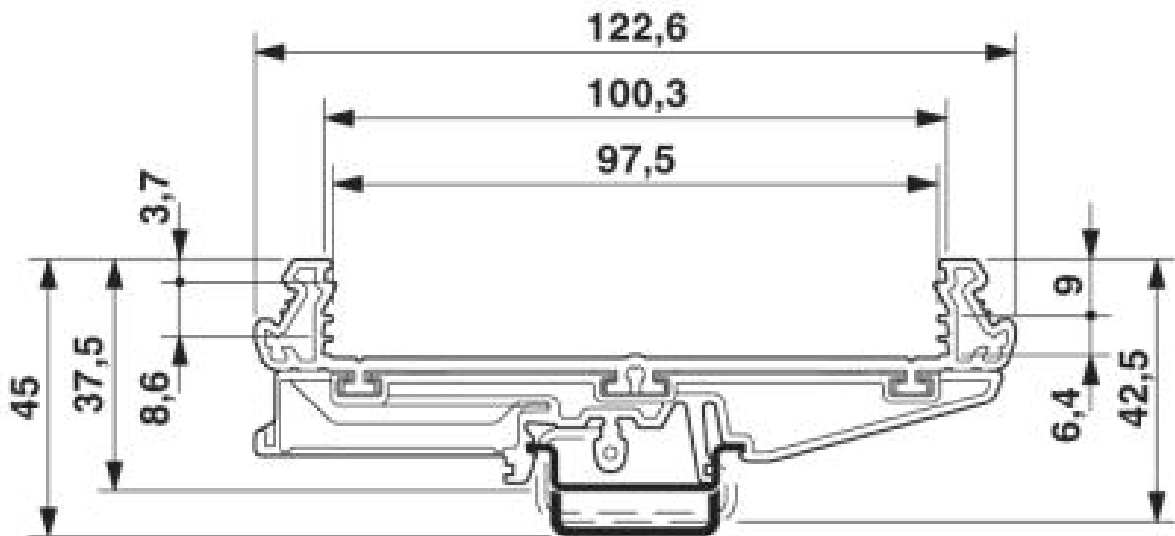

© Phoenix Contact 2014 - all rights reserved
<http://www.phoenixcontact.com>