

Base strip - MSTBVA 2,5/ 2-G-RN - 1944592

Please be informed that the data shown in this PDF Document is generated from our Online Catalog. Please find the complete data in the user's documentation. Our General Terms of Use for Downloads are valid (<http://download.phoenixcontact.com>)



Header, Nominal current: 12 A, Rated voltage (III/2): 320 V, Number of positions: 2, Pitch: 5 mm, Color: green, Contact surface: Tin, Assembly: Soldering, Article with engagement nose

The figure shows a 10-position version of the product

Product Features

- Plug-in direction vertical to the PCB
- Versions with engagement noses for locking plugs with self-locking flanges

Key commercial data

package_quantity	50
GTIN	4017918890872

Technical data

Dimensions

Length	8.6 mm
Pitch	5 mm
Dimension a	5 mm
Pin dimensions	1 x 1 mm
Hole diameter	1.4 mm

General

Range of articles	MSTBVA 2,5/..-G-RN
Insulating material group	IIIa
Rated surge voltage (III/3)	4 kV
Rated surge voltage (III/2)	4 kV
Rated surge voltage (II/2)	4 kV
Rated voltage (III/3)	250 V
Rated voltage (III/2)	320 V
Rated voltage (II/2)	400 V
Connection in acc. with standard	EN-VDE
Nominal current I _N	12 A
Insulating material	PBT
Inflammability class according to UL 94	V0
Color	green
Number of positions	2

Base strip - MSTBVA 2,5/ 2-G-RN - 1944592

Technical data

classifications

eCl@ss

eCl@ss 4.0	272607xx
eCl@ss 4.1	27260701
eCl@ss 5.0	27260701
eCl@ss 5.1	27260701
eCl@ss 6.0	27260704
eCl@ss 7.0	27440402
eCl@ss 8.0	27440402

ETIM

ETIM 3.0	EC001121
ETIM 4.0	EC002637
ETIM 5.0	EC002637

UNSPSC

UNSPSC 6.01	30211810
UNSPSC 7.0901	39121409
UNSPSC 11	39121409
UNSPSC 12.01	39121409
UNSPSC 13.2	39121409

approvals

UL Recognized / VDE Gutachten mit Fertigungsüberwachung / cUL Recognized / IECCE CB Scheme / CCA / cULus Recognized /

Approval details

UL Recognized 		
Usegroups	B	D
Nominal voltage UN	300 V	300 V
Nominal current IN	12 A	10 A
mm ² /AWG/kcmil		

VDE Gutachten mit Fertigungsüberwachung 	
Nominal voltage UN	250 V
Nominal current IN	12 A

Base strip - MSTBVA 2,5/ 2-G-RN - 1944592

approvals

mm ² /AWG/kcmil	
----------------------------	--

cUL Recognized 

Usegroups	B	D
Nominal voltage UN	300 V	300 V
Nominal current IN	12 A	10 A
mm ² /AWG/kcmil		

IECEE CB Scheme 

Nominal voltage UN	250 V
Nominal current IN	12 A
mm ² /AWG/kcmil	

CCA

Nominal voltage UN	250 V
Nominal current IN	12 A
mm ² /AWG/kcmil	

cULus Recognized 

Drawings

Base strip - MSTBVA 2,5/ 2-G-RN - 1944592

Drilling diagram

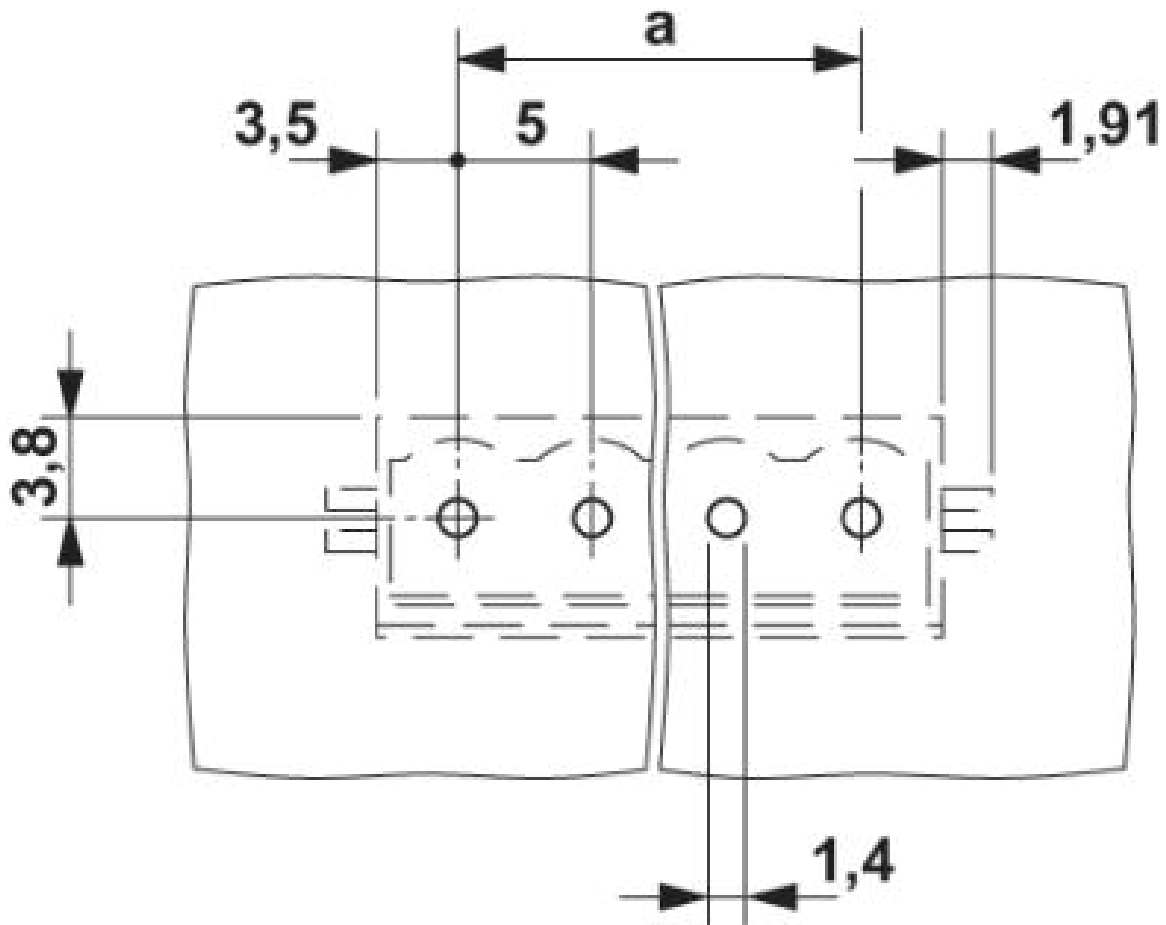

Base strip - MSTBVA 2,5/ 2-G-RN - 1944592

Dimensioned drawing

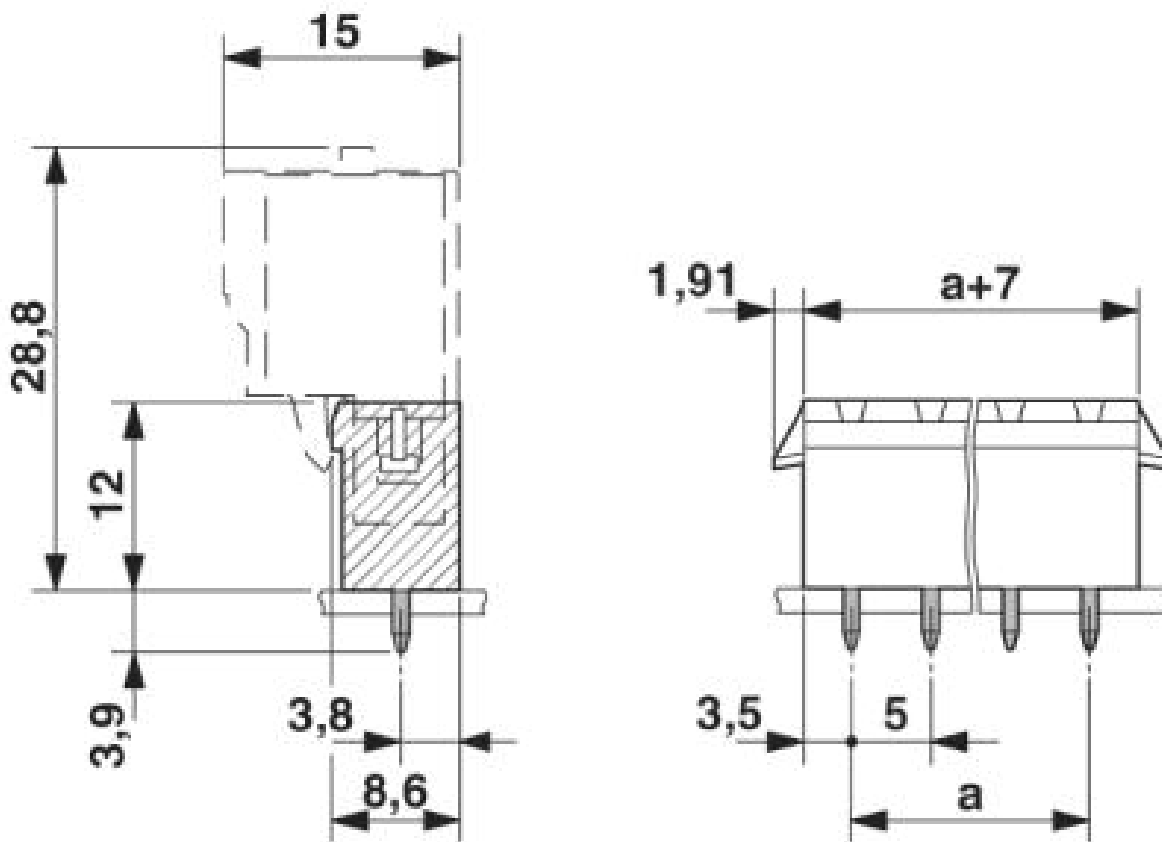

© Phoenix Contact 2014 - all rights reserved
<http://www.phoenixcontact.com>