

Interface module - VIP-3/SC/D37SUB/M - 2315146

Please be informed that the data shown in this PDF Document is generated from our Online Catalog. Please find the complete data in the user's documentation. Our General Terms of Use for Downloads are valid (<http://download.phoenixcontact.com>)



VARIOFACE module, with screw connection and male D-Subminiature pin strip, for mounting on NS 35 rails, 37-pos.

Product Features

- 9 to 50-pos.
- Metal foot
- According to IEC 60603-13
- Screw connection
- 1:1 connection



Key commercial data

package_quantity	1
GTIN	4046356313315

Technical data

Dimensions

Width	72.7 mm
Height	69 mm
Depth	62 mm

Ambient conditions

Ambient temperature (operation)	-20 °C ... 50 °C
Ambient temperature (storage/transport)	-20 °C ... 70 °C

General

Nominal voltage U_N	125 V AC/DC
Max. current carrying capacity per branch	2 A
Number of positions	37
Status display	No
Mounting position	any
Standards/regulations	IEC 60664
Standards/regulations	DIN EN 50178
Standards/regulations	IEC 62103

Interface module - VIP-3/SC/D37SUB/M - 2315146

Technical data

General

Pollution degree	2
Surge voltage category	II
Rated surge voltage	1.2 kV

Connection data for connection 1

Connection name	PCB connection
Connection in acc. with standard	IEC / EN
Connection method	Screw connection
Conductor cross section solid min.	0.2 mm ²
Conductor cross section solid max.	4 mm ²
Conductor cross section stranded min.	0.2 mm ²
Conductor cross section stranded max.	2.5 mm ²
Conductor cross section AWG/kcmil min.	24
Conductor cross section AWG/kcmil max	12
Stripping length	8 mm
Screw thread	M 3

Connection data for connection 2

Connection name	D-SUB connection
Number of connections	1
Connection method	D-SUB pin strip
Number of positions	37

classifications

eCl@ss

eCl@ss 4.0	27250313
eCl@ss 4.1	27250313
eCl@ss 5.0	27250313
eCl@ss 5.1	27250313
eCl@ss 6.0	27242608
eCl@ss 7.0	27141152
eCl@ss 8.0	27141152

ETIM

ETIM 2.0	EC001434
ETIM 3.0	EC001604
ETIM 4.0	EC001604
ETIM 5.0	EC002780

UNSPSC

UNSPSC 6.01	30211824
UNSPSC 7.0901	39121421
UNSPSC 11	39121421

Interface module - VIP-3/SC/D37SUB/M - 2315146

classifications

UNSPSC

UNSPSC 12.01	39121421
UNSPSC 13.2	39121421

approvals

CSA / UL Recognized / cUL Recognized / cULus Recognized /

Approval details

CSA	
Nominal voltage UN	105 V
Nominal current IN	2 A
mm ² /AWG/kcmil	30-12

UL Recognized	
Nominal voltage UN	125 V
Nominal current IN	2 A
mm ² /AWG/kcmil	30-12

cUL Recognized	
Nominal voltage UN	125 V
Nominal current IN	2 A
mm ² /AWG/kcmil	30-12

cULus Recognized	
-------------------------	--

accessories

System cable

Interface module - VIP-3/SC/D37SUB/M - 2315146

accessories

CABLE-D37SUB/B/S/ 50/KONFEK/S - 2302191



CABLE-D37SUB/B/S/100/KONFEK/S - 2302201



CABLE-D37SUB/B/S/150/KONFEK/S - 2302214



CABLE-D37SUB/B/S/200/KONFEK/S - 2302227



CABLE-D37SUB/B/S/300/KONFEK/S - 2302230



CABLE-D37SUB/B/S/400/KONFEK/S - 2302243



Interface module - VIP-3/SC/D37SUB/M - 2315146

accessories

CABLE-D37SUB/B/S/600/KONFEK/S - 2302256



CABLE D-SUB-S/.../.../... - 2302340



CABLE-D37SUB/B/B/ 100/KONFEK/S - 2305509



CABLE-D37SUB/B/B/ 200/KONFEK/S - 2305512



CABLE-D37SUB/B/B/ 300/KONFEK/S - 2305525



Interface module - VIP-3/SC/D37SUB/M - 2315146

accessories

CABLE D-SUB-B-B-S/.../.../... - 2302421



CABLE D-SUB-B-B-S/.../.../... - 2302421



Terminal marking

UC-TM 4 - 0818111



UC-TM 6 - 0818085



ZB 5,08:UNBEDRUCKT - 0809793



Interface module - VIP-3/SC/D37SUB/M - 2315146

accessories

ZB 22:UNBEDRUCKT - 0811862



accessories

BLUEMARK X1 - 5147777



Drawings

Interface module - VIP-3/SC/D37SUB/M - 2315146

Dimensioned drawing

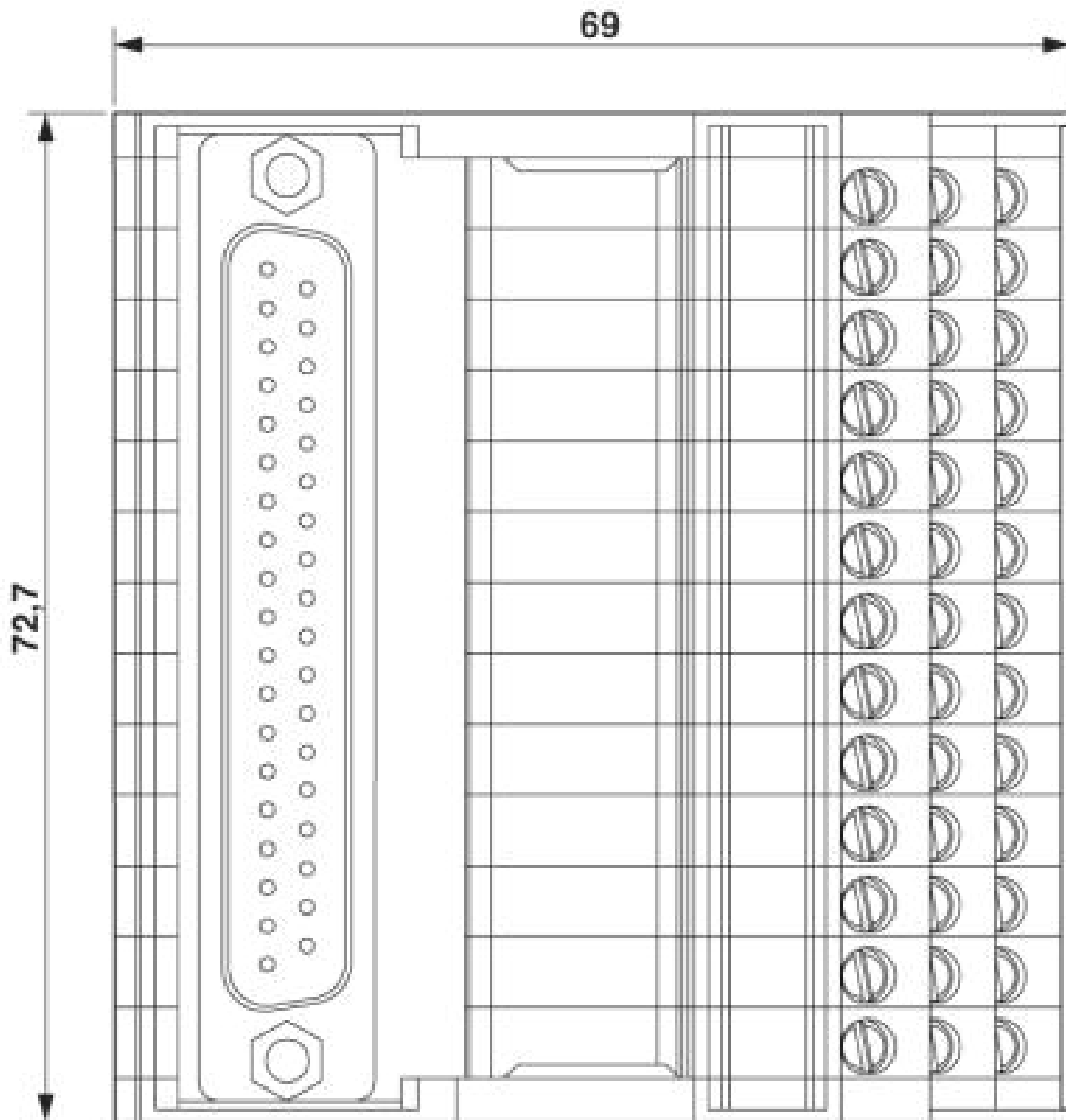

Interface module - VIP-3/SC/D37SUB/M - 2315146

Circuit diagram

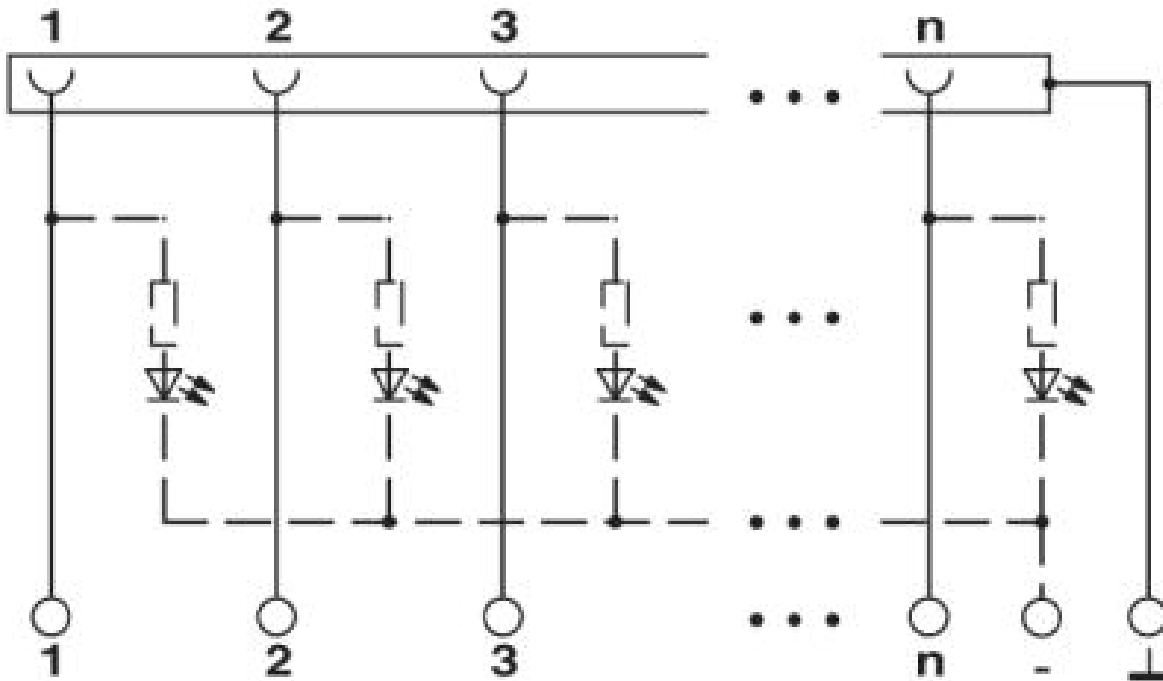

© Phoenix Contact 2014 - all rights reserved
<http://www.phoenixcontact.com>