

Panel feed-through - SACC-E-M12MS-4CON-PG9/0,5 - 1693762

Please be informed that the data shown in this PDF Document is generated from our Online Catalog. Please find the complete data in the user's documentation. Our General Terms of Use for Downloads are valid (<http://download.phoenixcontact.com>)



Sensor/Actuator flush-type plug, 4-pos., M12, A-coded, front/screw mounting with Pg9 thread, with 0.5 m TPE litz wire, 4 x 0.34 mm²

Key commercial data

package_quantity	1
GTIN	4017918174309

Technical data

Dimensions

Length of cable	0.5 m
-----------------	-------

Ambient conditions

Ambient temperature (operation)	-25 °C ... 85 °C (Plug / socket)
Degree of protection	IP67

General

Rated current at 40°C	4 A
Rated voltage	250 V
Number of positions	4
Contact resistance	≤ 3 mΩ
Insulation resistance	≥ 100 MΩ
Coding	A - standard
Standards/regulations	M12 connector IEC 61076-2-101
Status display	No
Surge voltage category	II
Pollution degree	3
Connection method	Individual wires
Insertion/withdrawal cycles	≥ 100
Mounting type	Front mounting Pg9

Material

Inflammability class according to UL 94	V0
Contact material	CuZn
Contact surface material	Ni/Au
Contact carrier material	PA66

Panel feed-through - SACC-E-M12MS-4CON-PG9/0,5 - 1693762

Technical data

Material

Material, knurls	Nickel-plated brass
Sealing material	NBR

Cable

Cable type	TPE litz wire
Conductor cross section	0.34 mm ²
AWG signal line	22
Conductor structure signal line	7x 0.25 mm
Core diameter including insulation	1.2 mm ±0.07 mm
Thickness, insulation	0.21 mm
Wire colors	brown, white, blue, black
Material conductor insulation	TPE
Conductor material	Tin-plated Cu litz wires
Insulation resistance	≥ 20 MΩ*km
Conductor resistance	≤ 57.6 Ω/km
Nominal voltage, cable	300 V
Test voltage, cable	2000 V AC
Ambient temperature (operation)	-25 °C ... 90 °C (cable, fixed installation)

classifications

eCl@ss

eCl@ss 4.0	27140815
eCl@ss 4.1	27140815
eCl@ss 5.0	27143423
eCl@ss 5.1	27143423
eCl@ss 6.0	27143423
eCl@ss 7.0	27449001
eCl@ss 8.0	27449001

ETIM

ETIM 2.0	EC001297
ETIM 3.0	EC002061
ETIM 4.0	EC002062
ETIM 5.0	EC002061

UNSPSC

UNSPSC 6.01	31251501
UNSPSC 7.0901	31251501
UNSPSC 11	31251501
UNSPSC 12.01	31251501
UNSPSC 13.2	31251501

Panel feed-through - SACC-E-M12MS-4CON-PG9/0,5 - 1693762

approvals

UL Recognized / GOST / GOST /

Approval details

UL Recognized	
Nominal voltage UN	250 V
Nominal current IN	4 A
mm ² /AWG/kcmil	26-20

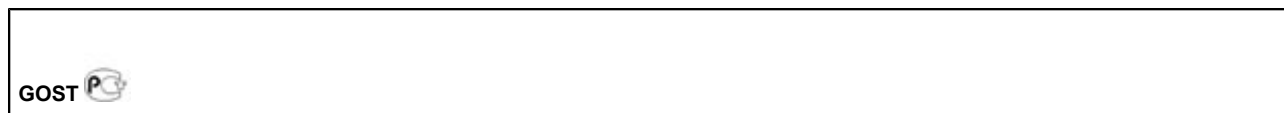

accessories

Flat nut

SACC-E-MU-PG9 - 1504084



Drawings

Panel feed-through - SACC-E-M12MS-4CON-PG9/0,5 - 1693762

Dimensioned drawing

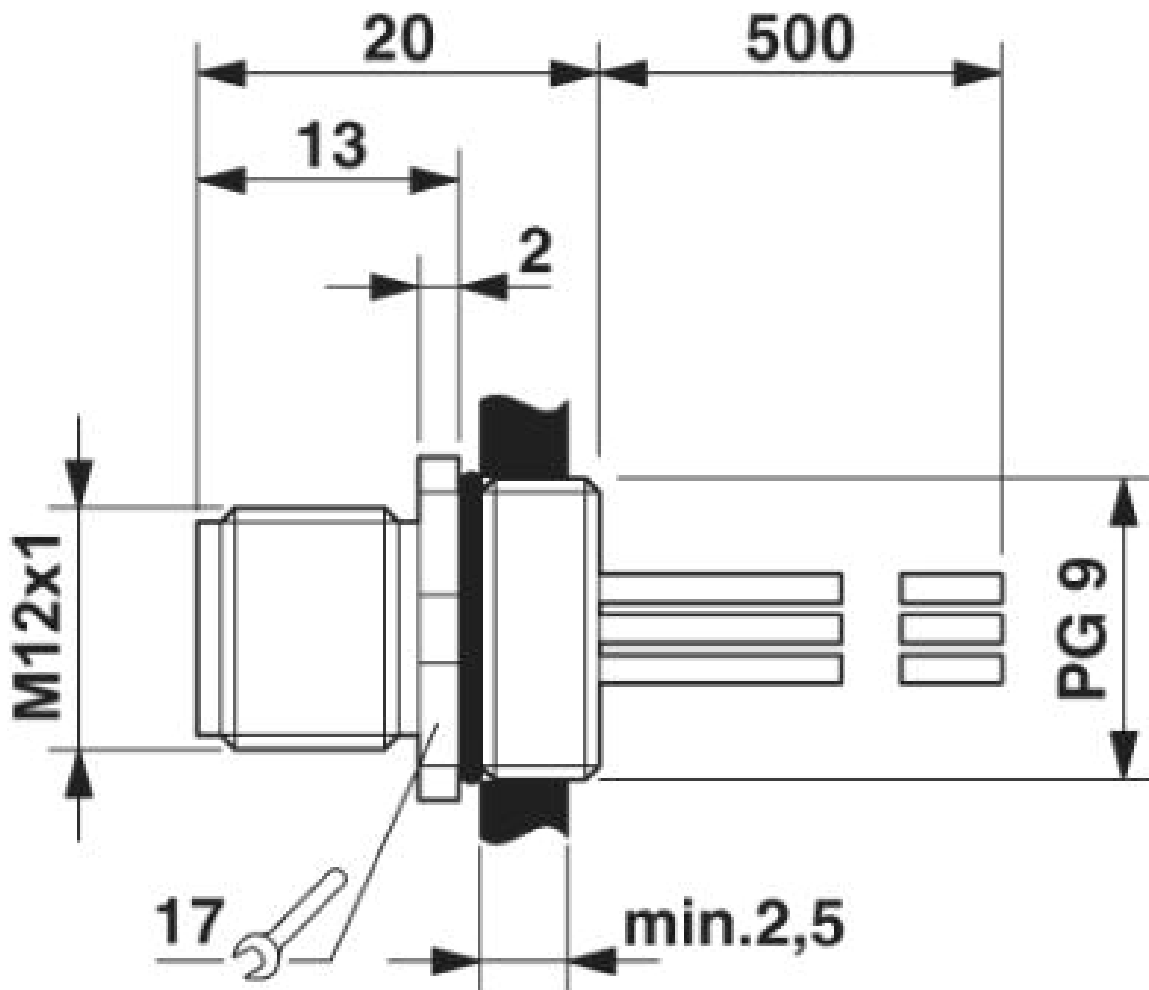

M12 flush-type connector

Panel feed-through - SACC-E-M12MS-4CON-PG9/0,5 - 1693762

Dimensioned drawing

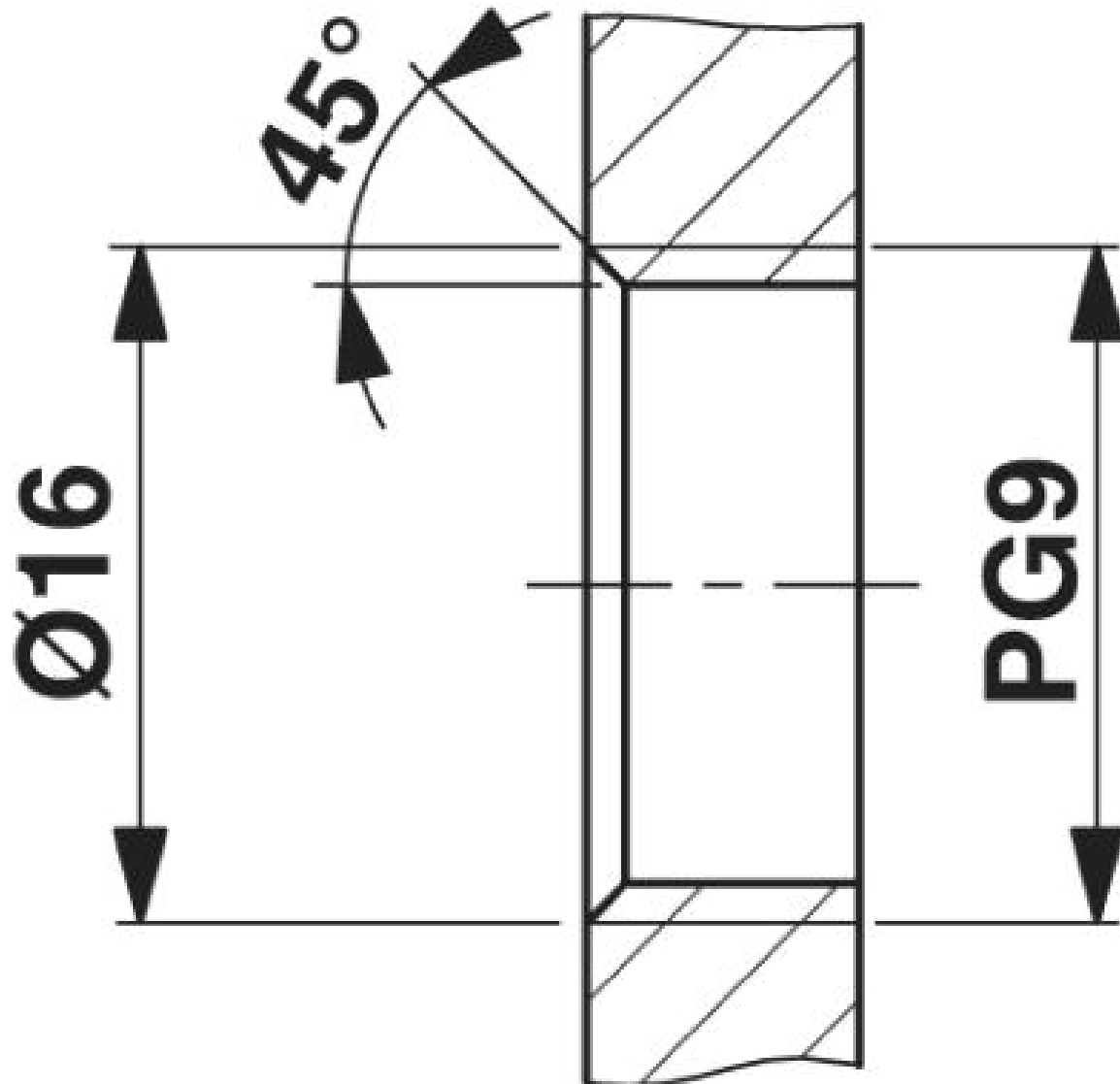

Housing cutout for Pg9 fastening thread, mounting panel with thread

Panel feed-through - SACC-E-M12MS-4CON-PG9/0,5 - 1693762

Dimensioned drawing

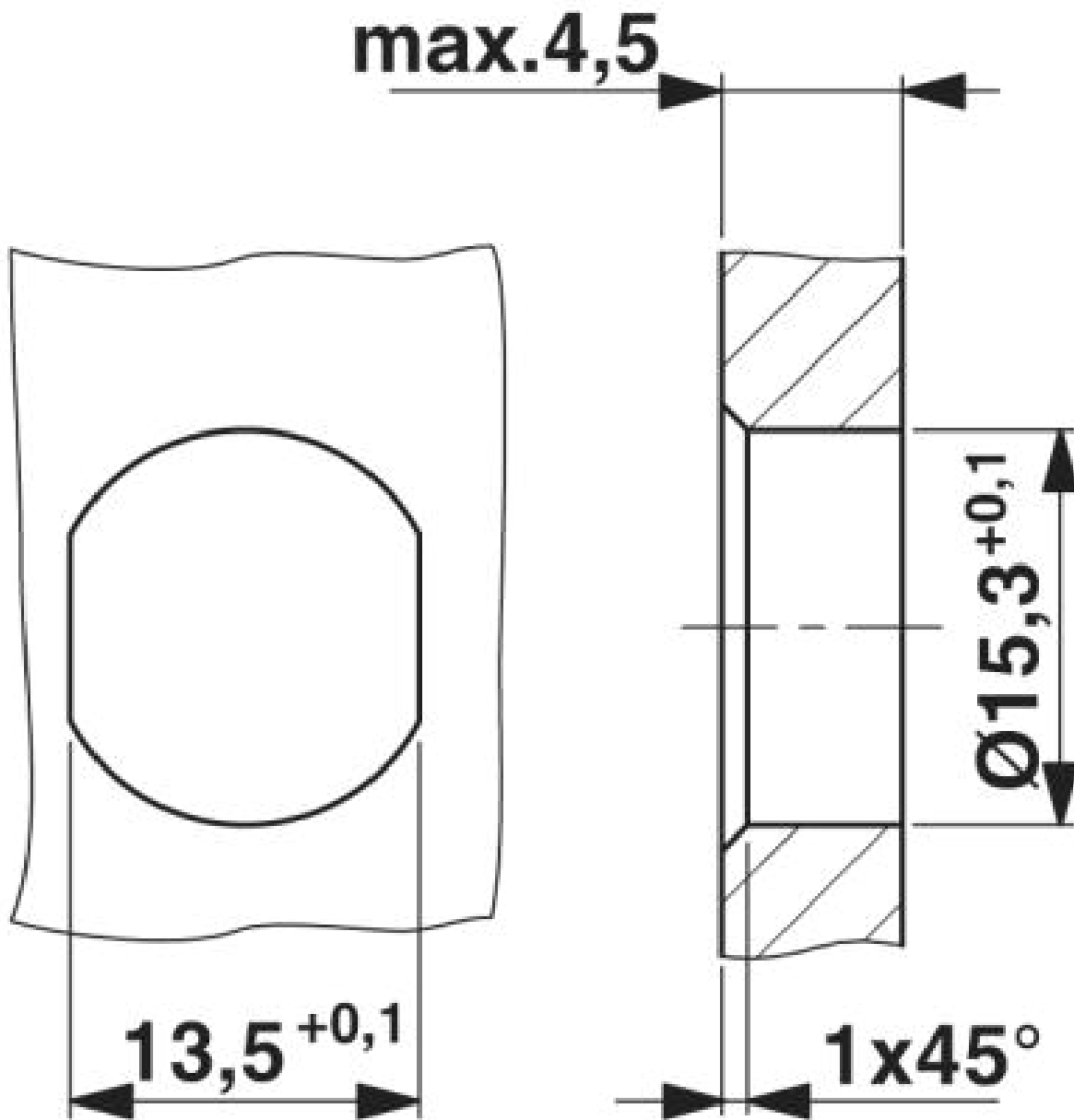

Housing cutout for Pg9 fastening thread, mounting panel with feed-through hole (alternatively with surface as protection against rotation)

Panel feed-through - SACC-E-M12MS-4CON-PG9/0,5 - 1693762

Circuit diagram

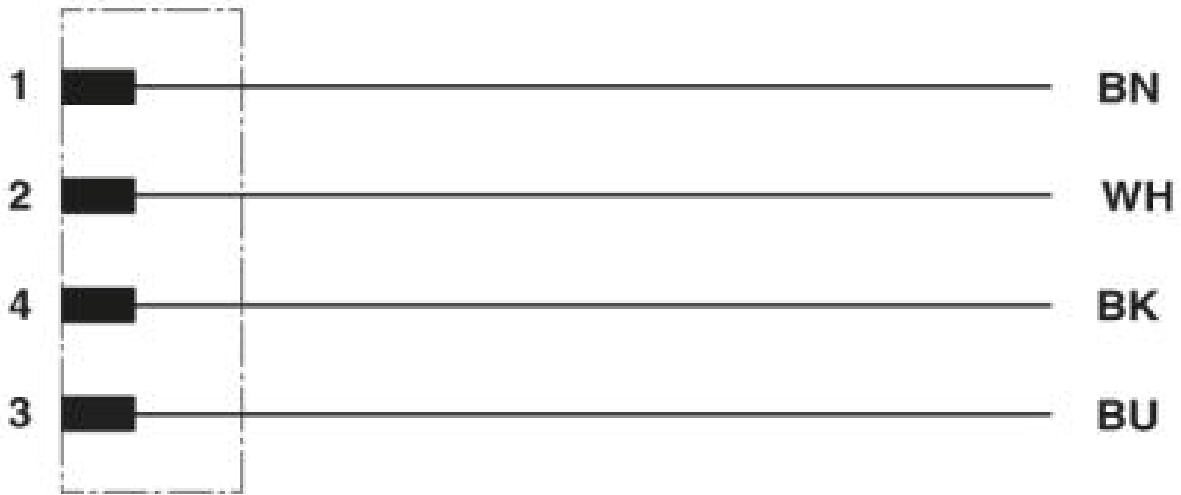

Contact assignment of the M12 plug and the M12 socket

Panel feed-through - SACC-E-M12MS-4CON-PG9/0,5 - 1693762

Schematic diagram

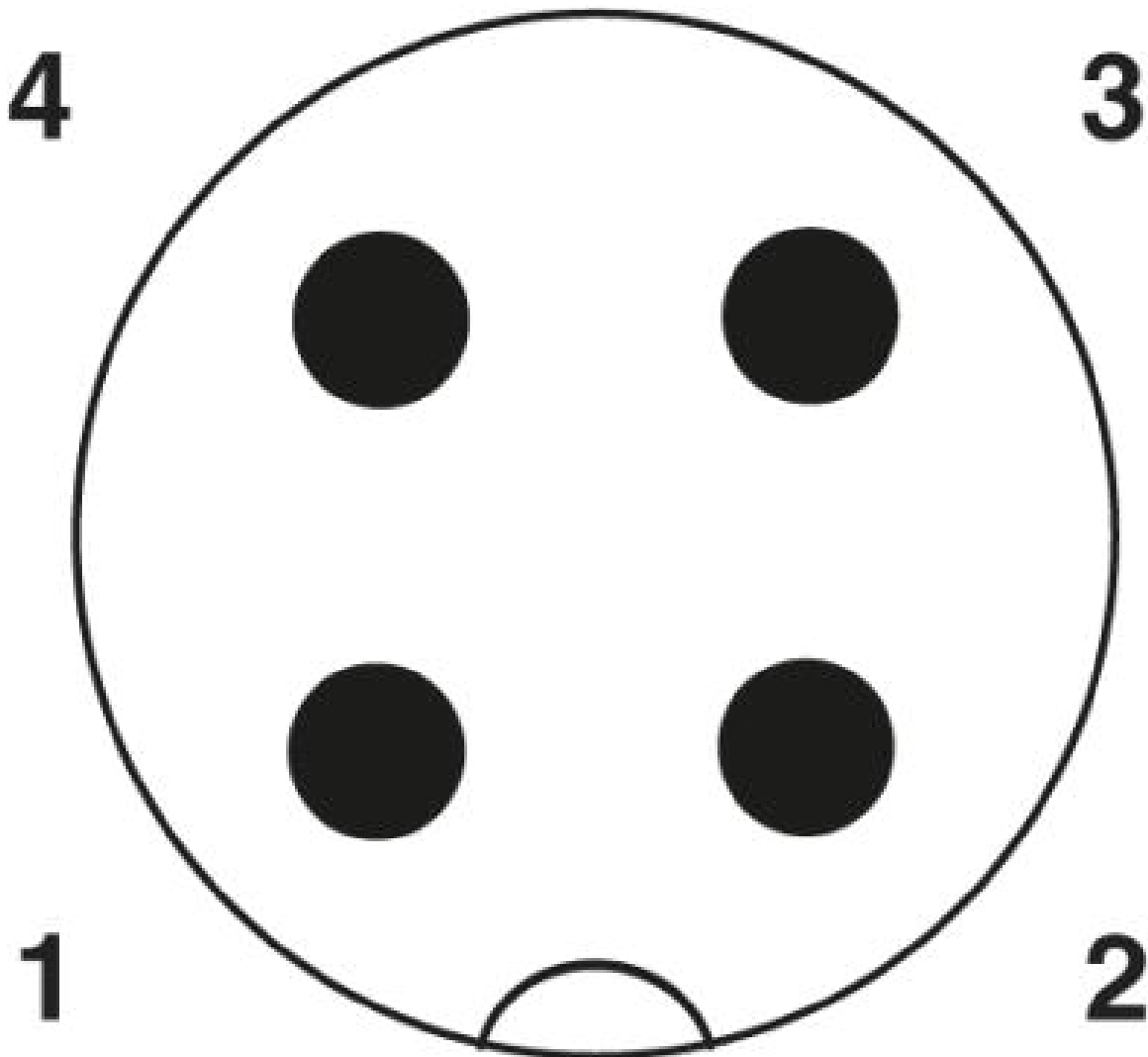

Pin assignment M12 plug, 4-pos., A-coded, view plug side

© Phoenix Contact 2014 - all rights reserved
<http://www.phoenixcontact.com>