

Sensor/Actuator cable - SAC-4P-3,0-600/M12FR FB - 1404015

Please be informed that the data shown in this PDF Document is generated from our Online Catalog. Please find the complete data in the user's documentation. Our General Terms of Use for Downloads are valid (<http://download.phoenixcontact.com>)



Sensor/Actuator cable, 4-position, PP-EPDM halogen-free, Gray RAL 7035, free cable end, on Socket angled M12, A-coded, Cable length: 3 m, Hygienic design, with plastic knurl

Product Features

- Easy and safe: 100% electrically tested plug-in components
- Easy to clean, thanks to the special hygienic design
- Contamination can be detected quickly – thanks to the light color

Key commercial data

package_quantity	1
GTIN	4046356677615

Technical data

Dimensions

Length of cable	3 m
------------------------	-----

Ambient conditions

Ambient temperature (operation)	-40 °C ... 105 °C (Plug / socket)
Degree of protection	IP65
Degree of protection	IP67
Degree of protection	IP68
Degree of protection	IP69K

General

Rated current at 40°C	4 A
Rated voltage	250 V
Number of positions	4
Contact resistance	≤ 5 mΩ
Insulation resistance	≥ 100 MΩ
Coding	A - standard
Standards/regulations	M12 connector IEC 61076-2-101
Standards/regulations	Material conformance FDA 21 CFR 177.2600
Status display	No
Protective circuit/component	Unwired
Surge voltage category	II
Pollution degree	3

Sensor/Actuator cable - SAC-4P-3,0-600/M12FR FB - 1404015

Technical data

General

Insertion/withdrawal cycles	≥ 100
Torque	0.4 Nm (M12 connector)

Material

Contact material	CuSn
Contact surface material	Ni/Au
Contact carrier material	PP
Material of grip body	PP
Material, knurls	Polypropylene
Sealing material	FKM

Cable

Cable type	Halogen-free PP gray
Cable type (abbreviation)	600
Cable abbreviation	Li9Y9Y
Conductor cross section	4x 0.34 mm ² (signal line)
AWG signal line	22
Conductor structure signal line	42x 0.10 mm
Core diameter including insulation	1.27 mm ±0.02 mm (signal line)
Thickness, insulation	≥ 0.21 mm (Core insulation)
Wire colors	brown, white, blue, black
Overall twist	4 wires, twisted
Length of twist, overall twist	48 mm
External sheath, color	Gray RAL 7035
Outer sheath thickness	approx. 0.8 mm
External cable diameter D	4.7 mm ±0.15 mm
Minimum bending radius, fixed installation	5 x D
Minimum bending radius, flexible installation	10 x D
Cable weight	30 kg/km
Outer sheath, material	PP-EPDM
Material conductor insulation	PP
Conductor material	Bare Cu litz wires
Conductor resistance	58 Ω/km (at 20 °C)
Nominal voltage, cable	≤ 300 V AC
Test voltage, cable	≥ 3000 V AC (Spark test)
Special properties	FDA compliant according to FDA 21 CFR 177.2600
Halogen-free	in accordance with DIN VDE 0472 part 815
Ambient temperature (operation)	-40 °C ... 105 °C (cable, fixed installation)
Ambient temperature (operation)	-25 °C ... 105 °C (cable, flexible installation)

classifications

eCl@ss

Sensor/Actuator cable - SAC-4P-3,0-600/M12FR FB - 1404015

classifications

eCl@ss

eCl@ss 4.0	27060306
eCl@ss 4.1	27060306
eCl@ss 5.0	27061801
eCl@ss 5.1	27061801
eCl@ss 6.0	27061801
eCl@ss 7.0	27061801
eCl@ss 8.0	27061801

ETIM

ETIM 3.0	EC001855
ETIM 4.0	EC001855
ETIM 5.0	EC001855

UNSPSC

UNSPSC 6.01	31251501
UNSPSC 7.0901	31251501
UNSPSC 11	31251501
UNSPSC 12.01	31251501
UNSPSC 13.2	31251501

accessories

Cutting tools

CUTFOX-S VDE - 1212207



Stripping tool

WIREFOX SAC - 1212623



Sensor/Actuator cable - SAC-4P-3,0-600/M12FR FB - 1404015

accessories

WIREFOX 10 - 1212150



Drawings

Sensor/Actuator cable - SAC-4P-3,0-600/M12FR FB - 1404015

Dimensioned drawing

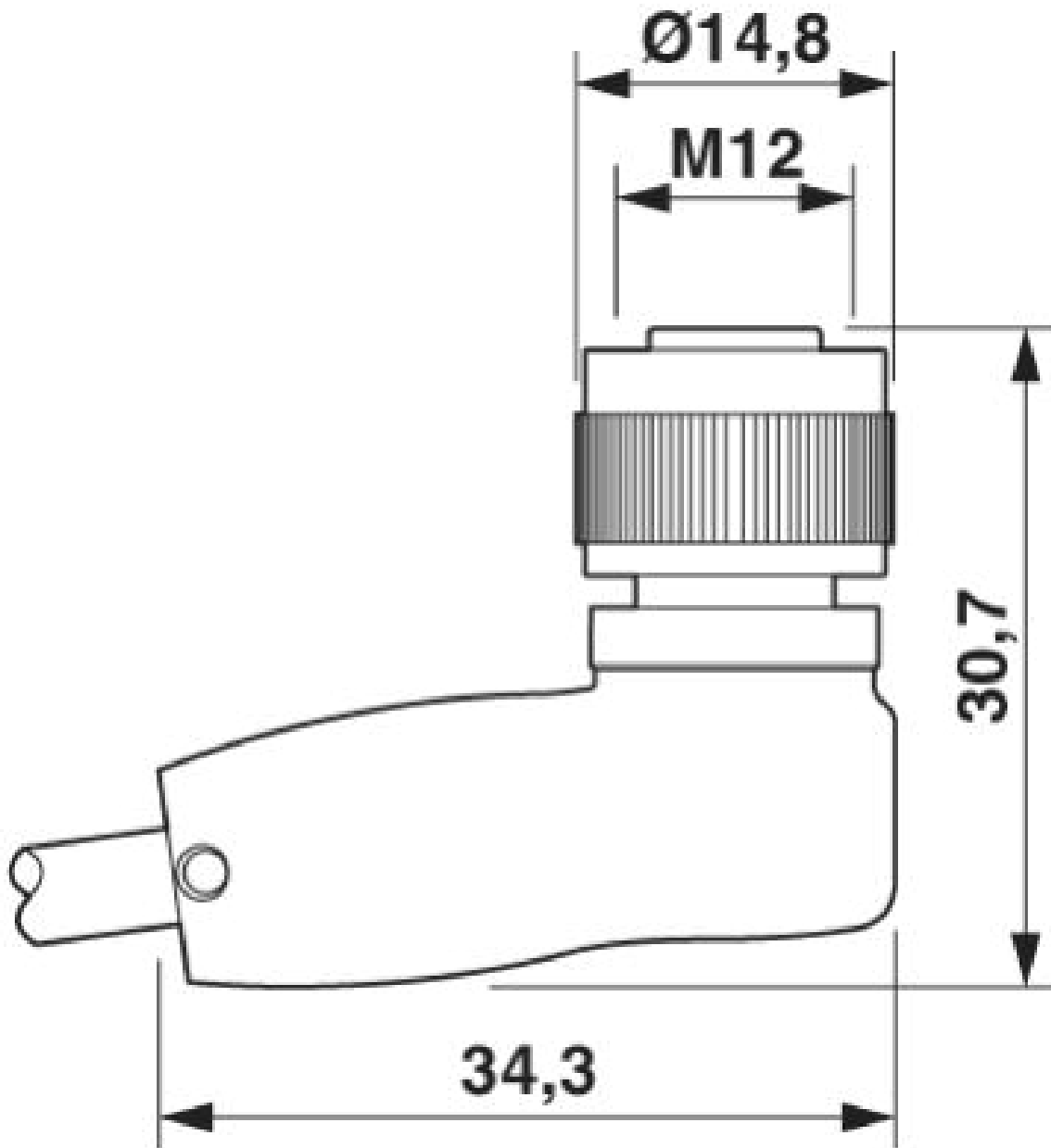

M12 x 1 socket, angled

Sensor/Actuator cable - SAC-4P-3,0-600/M12FR FB - 1404015

Circuit diagram

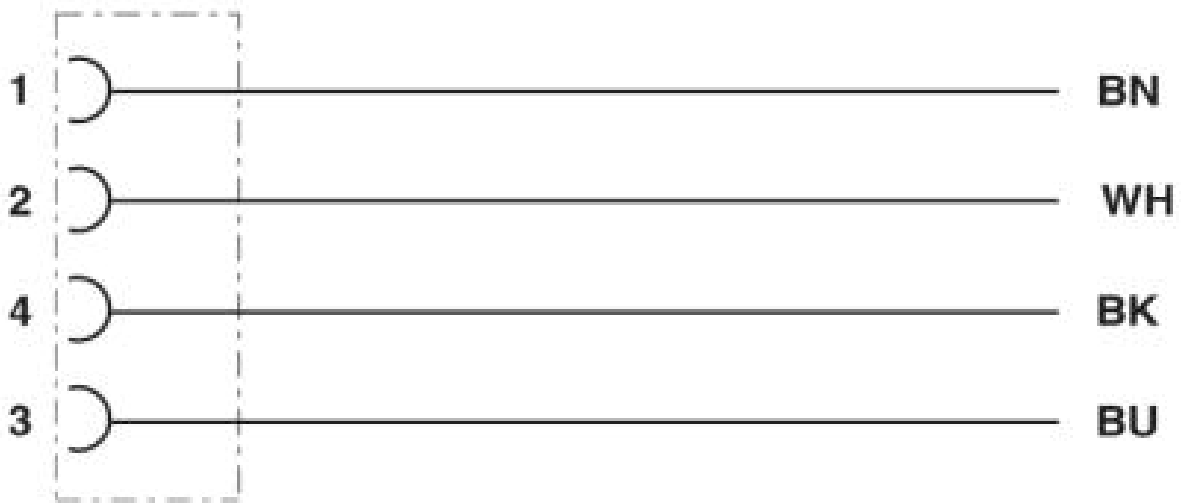

Contact assignment of the M12 socket

Sensor/Actuator cable - SAC-4P-3,0-600/M12FR FB - 1404015

Schematic diagram

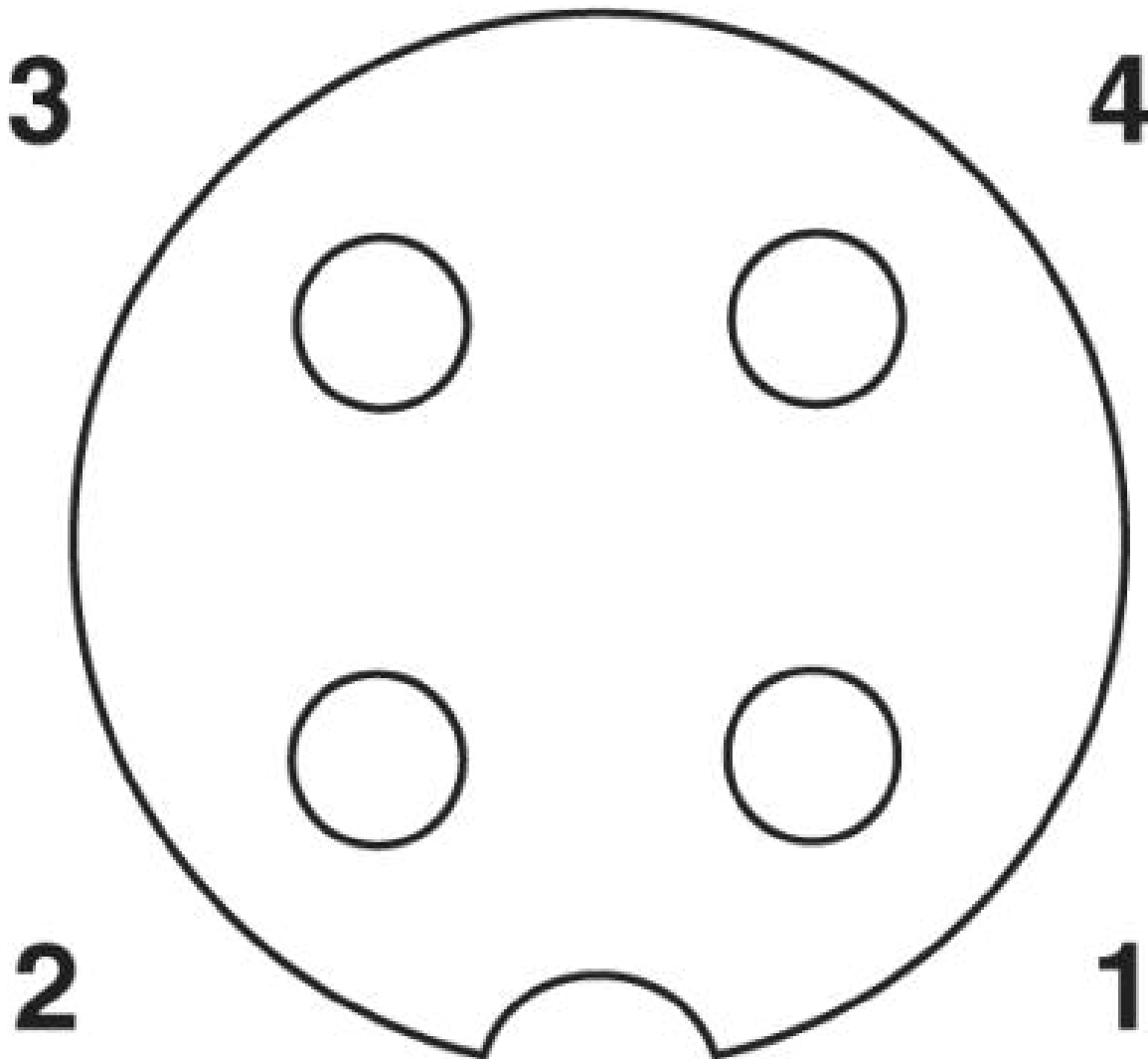

Pin assignment M12 socket, 4-pos., A-coded, view female side

Sensor/Actuator cable - SAC-4P-3,0-600/M12FR FB - 1404015

Cable cross section

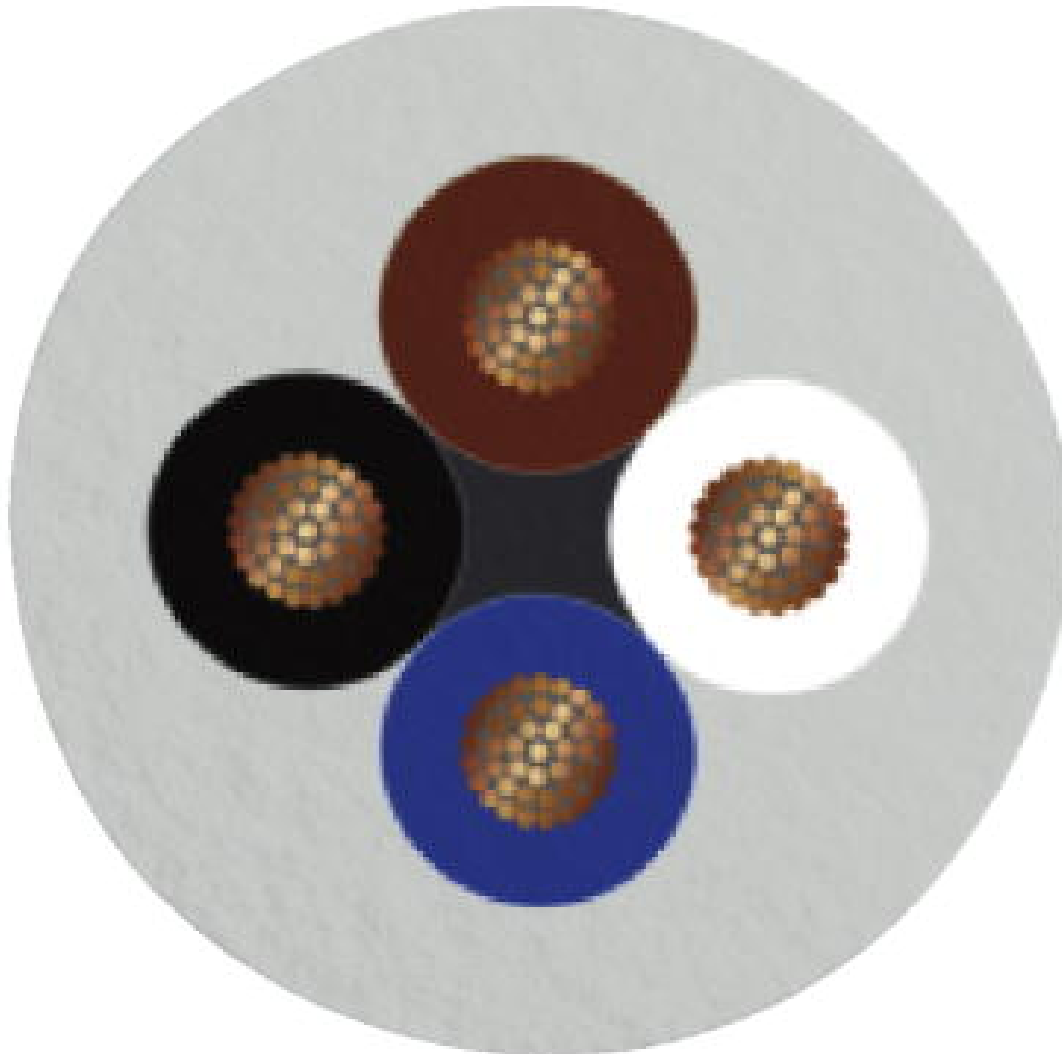

Halogen-free PP gray [600]

© Phoenix Contact 2014 - all rights reserved
<http://www.phoenixcontact.com>