

Cable sleeve - CES-STPG-GY-6 - 0801676

Please be informed that the data shown in this PDF Document is generated from our Online Catalog. Please find the complete data in the user's documentation. Our General Terms of Use for Downloads are valid (<http://download.phoenixcontact.com>)



Small, slotted cable sleeves suitable for cables with a diameter of 5 ... 6 mm, material: SEBS

Product Description

Slotted sleeves for accommodating pre-assembled cables and lines with a diameter of 5 ... 6 mm, can be used in CES sealing frames. When fitted, the sleeves also ensure strain relief according to DIN EN 50262.

Key commercial data

package_quantity	10
GTIN	4046356674829

Technical data

Dimensions

External cable diameter	1x 5 mm ... 6 mm
Length	29.5 mm
Width	19.5 mm
Height	17 mm

Ambient conditions

Degree of protection	IP54
Degree of protection	IP55 (when using a CES-B...-SFFS-PLBK sealing frame with screw locking)
Ambient temperature (operation)	-40 °C ... 80 °C (static)

General

Product description	Slotted sleeves for accommodating pre-assembled cables and lines with a diameter of 5 ... 6 mm, can be used in CES sealing frames. When fitted, the sleeves also ensure strain relief according to DIN EN 50262.
Material	SEBS
Inflammability class according to UL 94	V0
Color	gray

classifications

eCl@ss

eCl@ss 4.0	27081002
-------------------	----------

Cable sleeve - CES-STPG-GY-6 - 0801676

classifications

eCl@ss

eCl@ss 4.1	27081002
eCl@ss 5.0	27081002
eCl@ss 5.1	27081002
eCl@ss 6.0	27081002
eCl@ss 7.0	27081002
eCl@ss 8.0	27081002

ETIM

ETIM 3.0	EC000879
ETIM 4.0	EC000451
ETIM 5.0	EC000451

UNSPSC

UNSPSC 6.01	30212109
UNSPSC 7.0901	39121708
UNSPSC 11	39121708
UNSPSC 12.01	39121708
UNSPSC 13.2	39121708

approvals

UL Recognized / cUL Recognized / cULus Recognized /

Approval details

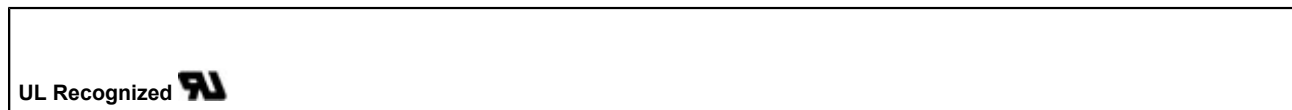

Drawings

Cable sleeve - CES-STPG-GY-6 - 0801676

Dimensioned drawing

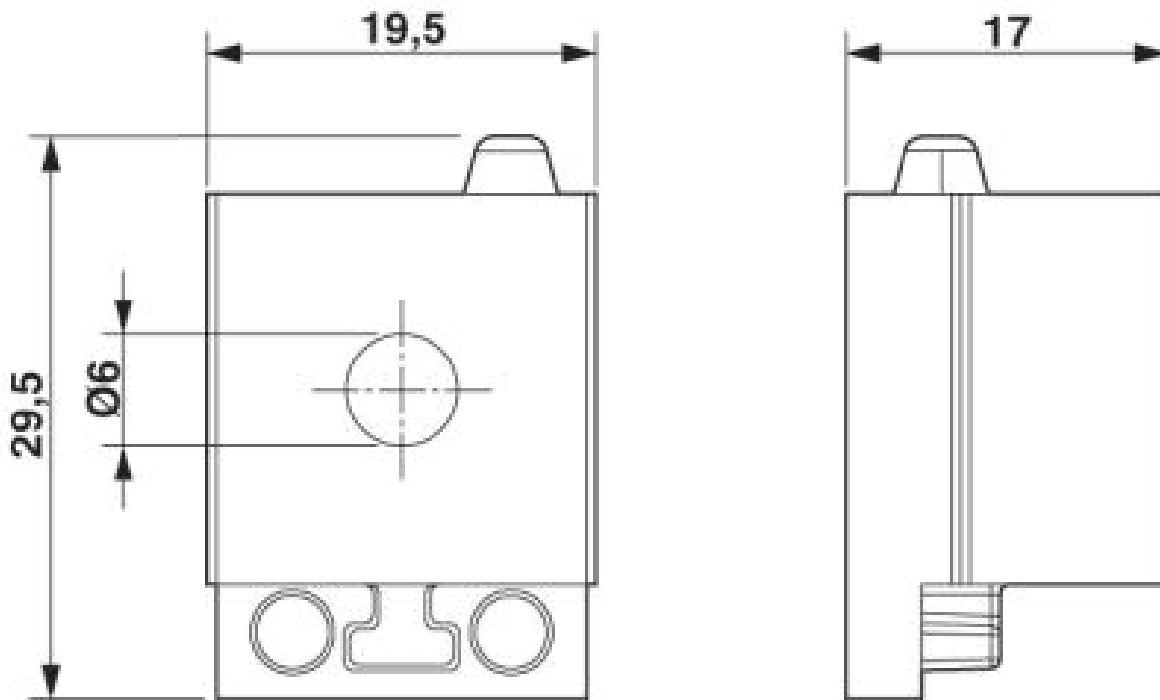

Dimensional drawing

© Phoenix Contact 2014 - all rights reserved
<http://www.phoenixcontact.com>