

Compact Rail-Mounted Terminal Blocks for DIN 15 and DIN 35 Rails 870 Series

Assembly

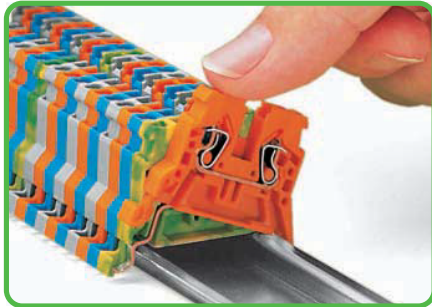

Snapping a rail-mount terminal block onto DIN 35 carrier rail.

Removal

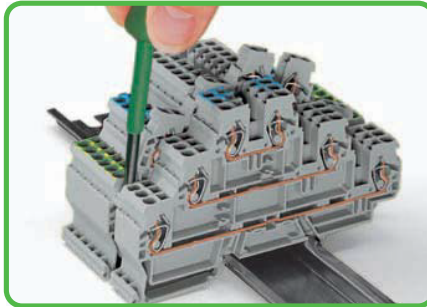

Removing a terminal block from the assembly.

Insulation stop

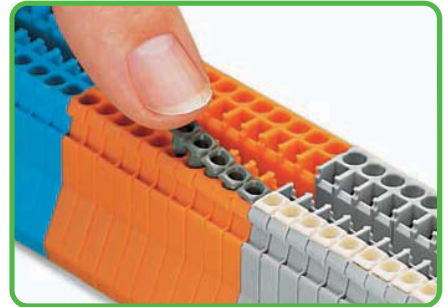

Inserting an insulation stop.

Push-in type jumper bar system



Push jumper bars down firmly until fully inserted. When using multipole bars, push alternately on right and then left side, until installed.
Push-in type jumper bars 1 - 3 - 5 - 7 or 1 - - 4 - - 7 upon request.

Push-in type jumper bar system

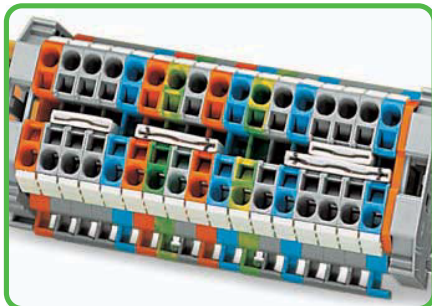

Two parallel jumper receptacles are accommodated in one terminal block.

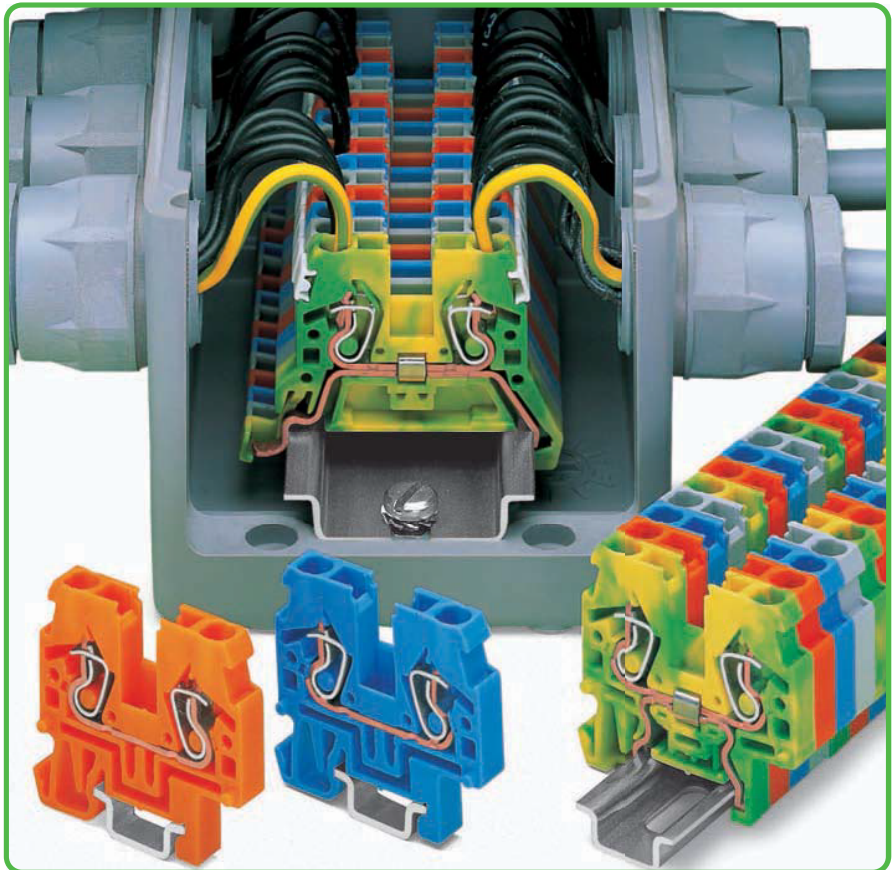

Commoning with step-down jumpers

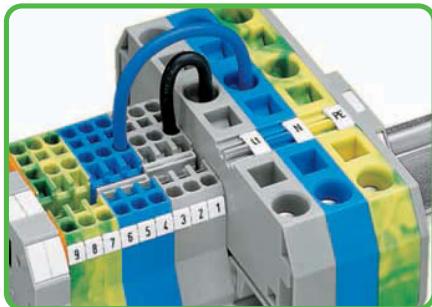

Commoning terminal blocks of different sizes - step-down.

Testing

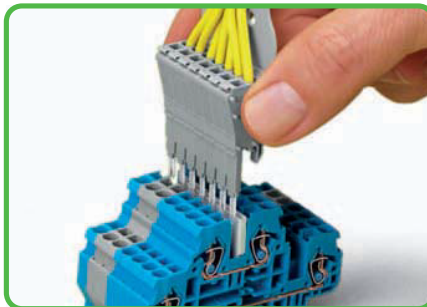

Testing is also possible using a pre-wired module assembly, similar to test plugs.

Testing

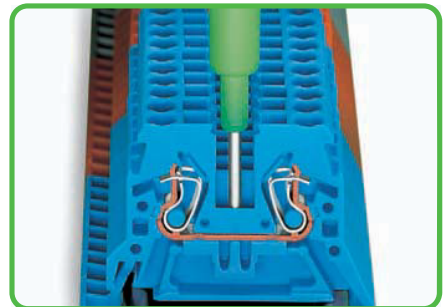

Testing with phase testing device, also possible with single-pole voltage tester.



CAGE CLAMP® clamps the following copper conductors:*

solid



stranded



fine-stranded, also with tinned single strands

* For aluminum conductors, see notes in Section 14.

① When using ferrules, the max. conductor cross section accommodated is one size smaller than max. rating of terminal block.

- Description and Handling -

CAGE CLAMP® connection

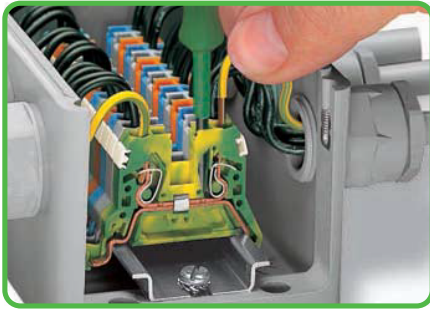

Terminating fine-stranded conductors ranging from 0.08 to 4 mm² (AWG 28 - 12).

CAGE CLAMP® connection

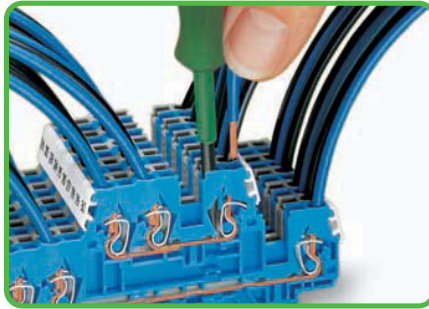

Multilevel terminal blocks

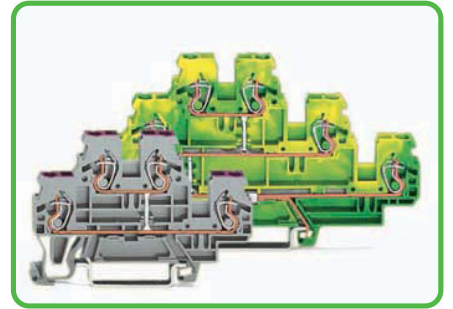

Double- and triple-deck terminal blocks with internal commoning acting as 4- and 6-conductor terminal blocks.

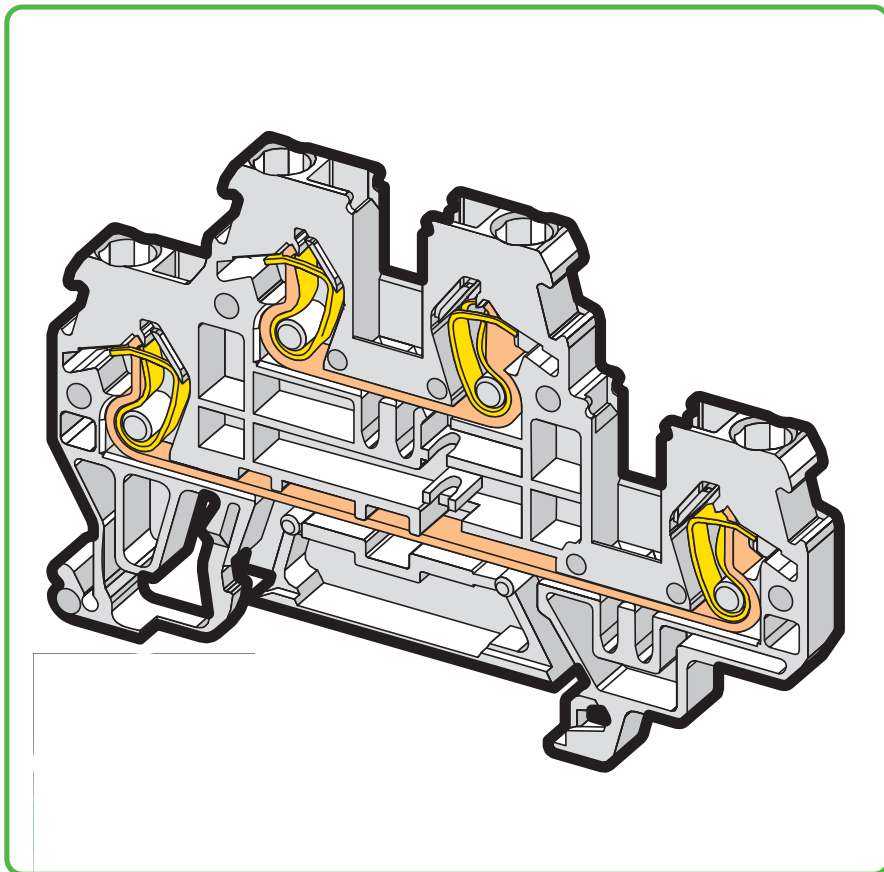

Protective warning marker

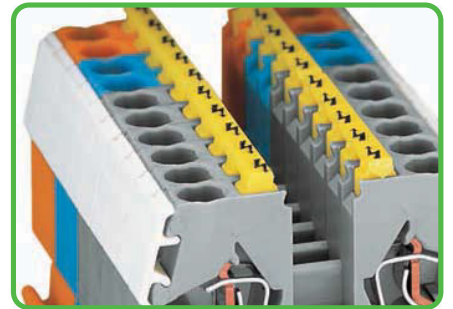

Protective warning markers (280-405), with black high-voltage symbols.

Marking

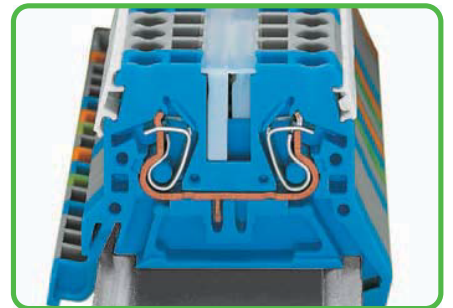

Marking the clamping unit via WMB Multi marking system or miniature WSB Quick marking system.

Space saver

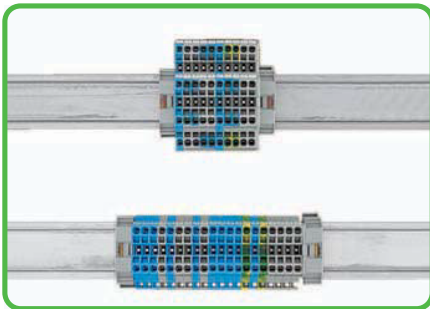

Save 50% of rail space when using double-deck terminal blocks.

Space saver

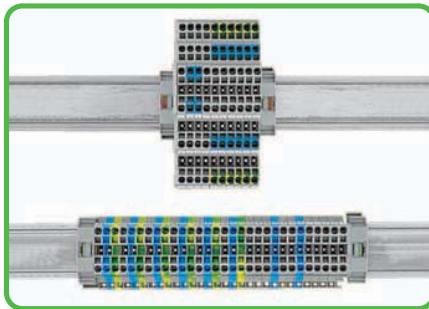

Save 67% of rail space when using triple-deck terminal blocks.

Marking Strips

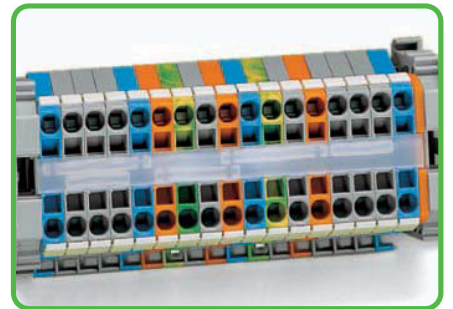

Transparent marker strips (note: Jumpers below may be visible).

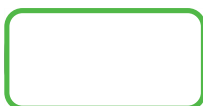

fine-stranded, tip-bonded

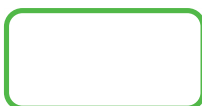

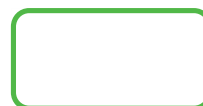

fine-stranded, with ferrule ① (gas-tight crimped)



fine-stranded, with pin terminal (gas-tight crimped)

Double-Deck Terminal Blocks 2.5 mm² (4 mm² "f-st") 870 Series

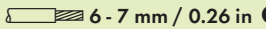

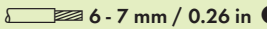
0.08 - 2.5 (4 "f-st") mm ² ① 500 V/6 kV/3 ② I _N 24 A Terminal block width 5 mm / 0.197 in  6 - 7 mm / 0.26 in ③	AWG 28 - 12 300 V, 20 A 	0.08 - 2.5 (4 "f-st") mm ² ① 500 V/6 kV/3 ② I _N 24 A Terminal block width 5 mm / 0.197 in  6 - 7 mm / 0.26 in ③	AWG 28 - 12
--	--	--	-------------

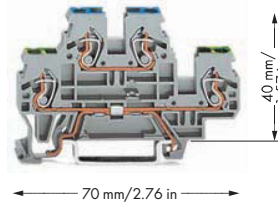
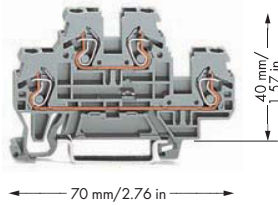

- ① Max. insulation diameter: 4.4 mm
- ② 500 V = rated voltage
6 kV = rated surge voltage
3 = pollution degree
(also see Section 14)
- ③ Strip length, see packaging or instructions.
- ④ Suitable for Ex i applications
- ⑤ Suitable for Ex e II applications
0.2 mm² - 2.5 (4 "f-st") mm²/AWG 24 - 12
440 V, 18 A
Using push-in type jumper bars 1 to X, the maximum rated voltage is reduced to 275 V and the rated current to 13.5 A
(also see Section 14)
- ⑥ See application notes for:
Insulation stop, page 199

Item No.	Pack. Unit	Item No.	Pack. Unit	Accessories
Through/through terminal block, gray housing		Ground conductor/through terminal block, gray housing		WMB/Miniature WSB (see Section 13)
○ L/L 870-501	50	○ PE/N 870-517	50	
○ N/L 870-502	50	○ PE/L 870-527	50	End and intermediate plate, 2 mm thick
○ L/N 870-503	50			orange 870-519 100 (4x25)
Through/through terminal block, blue housing				gray 870-518 100 (4x25)
● N/N 870-504 ④	50			Ex e/Ex i separator, orange, 3 mm thick
Through/through terminal block, light gray housing		Ground conductor/through terminal block, light gray housing		125.5 mm 209-192 50 (2x25)
○ L/L ⑤ 870-961 ⑤	50	○ PE/L ⑤ 870-967/999-950 ⑤	50	Insulation stop,
Other terminal blocks with the same profile:				⑥ 5 pcs/strip, 0.08 - 0.2 mm ² "s" (0.14 mm ² "f-st") white 280-470 200 (8x25)
Diode 870-540/281-410 Page 288				Insulation stop,
LED 870-543/281-434 Page 288				⑥ 5 pcs/strip, 0.25 - 0.5 mm ² light gray 280-471 200 (8x25)

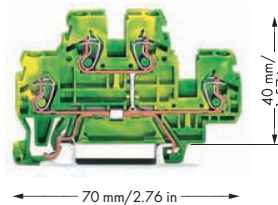
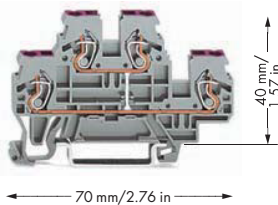

Item No.	Pack. Unit	Item No.	Pack. Unit	Accessories
4-conductor through terminal block, internal commoning, conductor entry position colored in violet, gray housing		4-conductor ground terminal block, internal commoning, green-yellow housing		Push-in type jumper bar, insulated, I _N 18 A, light gray
○ L 870-508	50	● PE 870-507	50	
4-conductor through terminal block, internal commoning, conductor entry position colored in violet, blue housing				3-way 870-403 200 (8x25)
● N 870-509 ④	50			4-way 870-404 200 (8x25)
				5-way 870-405 100 (4x25)
				6-way 870-406 100 (4x25)
				7-way 870-407 100 (4x25)
				8-way 870-408 100 (4x25)
				9-way 870-409 100 (4x25)
				10-way 870-410 100 (4x25)
				Push-in type jumper bar, insulated, I _N 18 A, light gray
				from 1 to 3 870-433 200 (8x25)
				from 1 to 4 870-434 200 (8x25)
				from 1 to 5 870-435 100 (4x25)
				from 1 to 6 870-436 100 (4x25)
				from 1 to 7 870-437 100 (4x25)
				from 1 to 8 870-438 100 (4x25)
				from 1 to 9 870-439 100 (4x25)
				from 1 to 10 870-440 100 (4x25)
				Protective warning marker, with high-voltage symbol, black, for 5 terminal blocks
				yellow 280-405 100 (4x25)