

Compact Rail-Mounted Terminal Blocks for DIN 15 and DIN 35 Rails 870 Series

Assembly

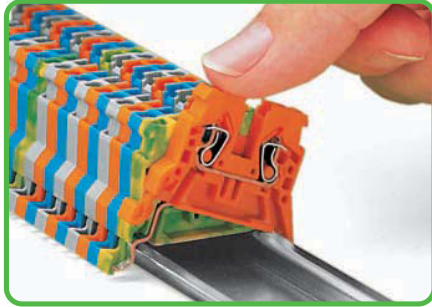

Snapping a rail-mount terminal block onto DIN 35 carrier rail.

Removal

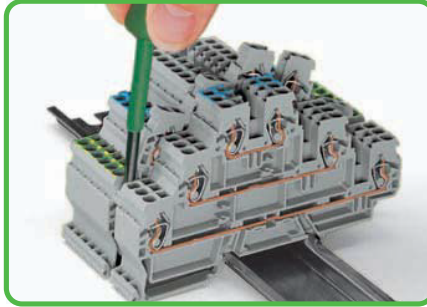

Removing a terminal block from the assembly.

Insulation stop

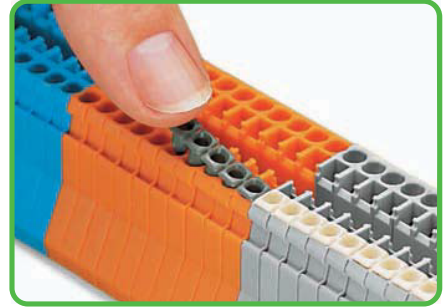

Inserting an insulation stop.

Push-in type jumper bar system

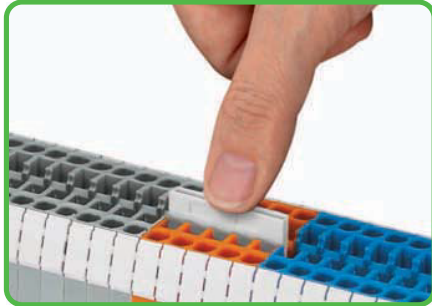

Push jumper bars down firmly until fully inserted. When using multipole bars, push alternately on right and then left side, until installed.
Push-in type jumper bars 1 - 3 - 5 - 7 or 1 - - 4 - - 7 upon request.

Push-in type jumper bar system

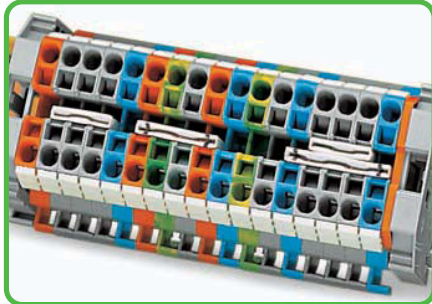

Two parallel jumper receptacles are accommodated in one terminal block.

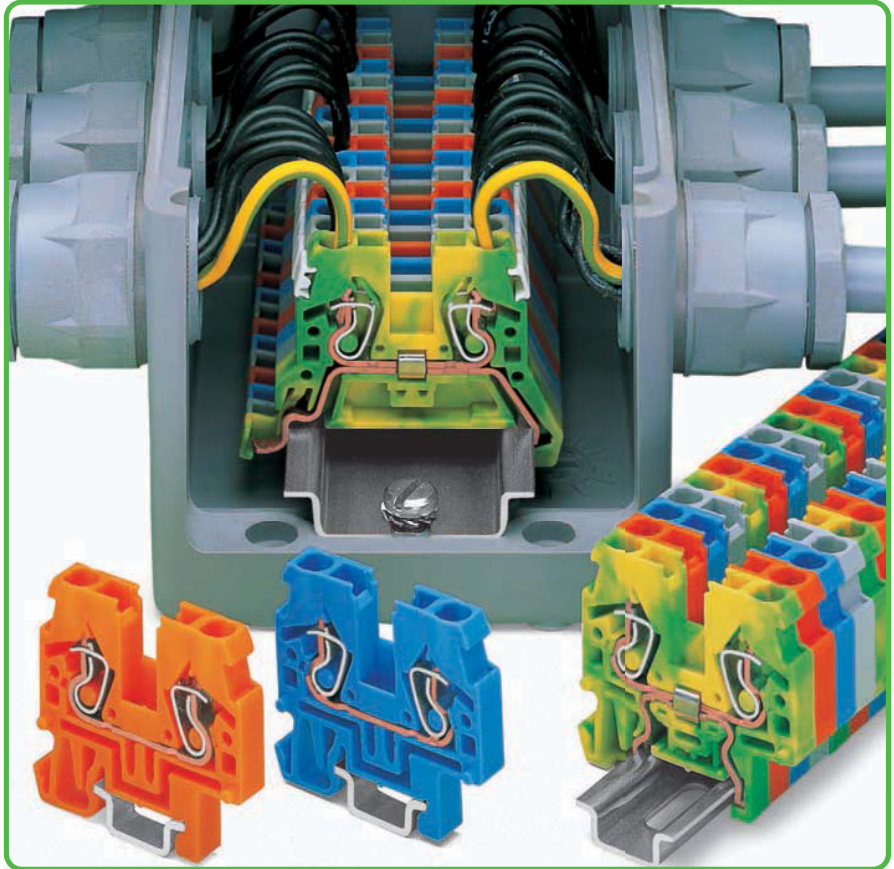

Commoning with step-down jumpers

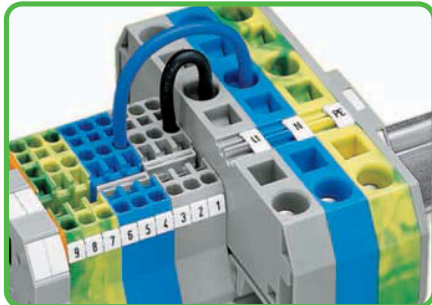

Commoning terminal blocks of different sizes - step down.

Testing

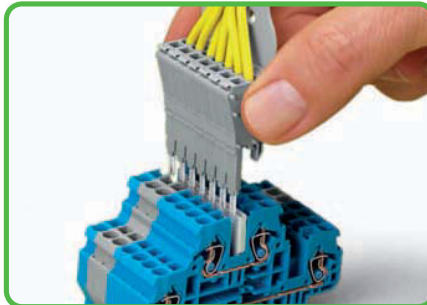

Testing is also possible using a pre-wired module assembly, similar to test plugs.

Testing

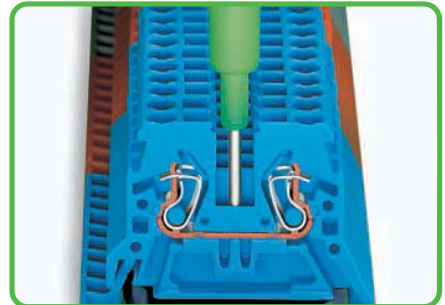

Testing with phase testing device, also possible with single-pole voltage tester.

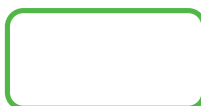

CAGE CLAMP® clamps the following copper conductors:*

solid

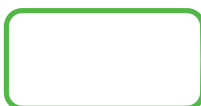

stranded

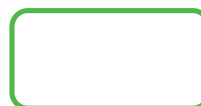

fine-stranded, also with tinned single strands

* For aluminum conductors, see notes in Section 14.

① When using ferrules, the max. conductor cross section accommodated is one size smaller than max. rating of terminal block.

- Description and Handling -

CAGE CLAMP® connection

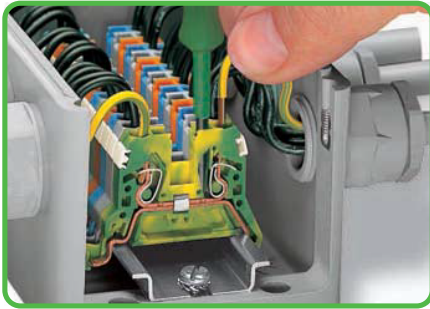

Terminating fine-stranded conductors ranging from 0.08 to 4 mm² (AWG 28 - 12).

CAGE CLAMP® connection

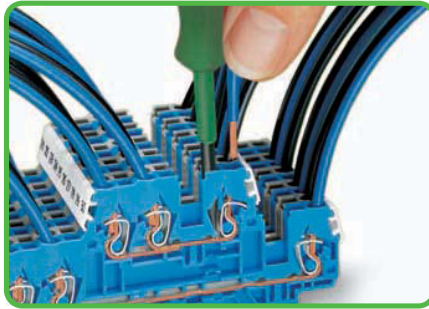

Multilevel terminal blocks



Double- and triple-deck terminal blocks with internal commoning acting as 4- and 6-conductor terminal blocks.

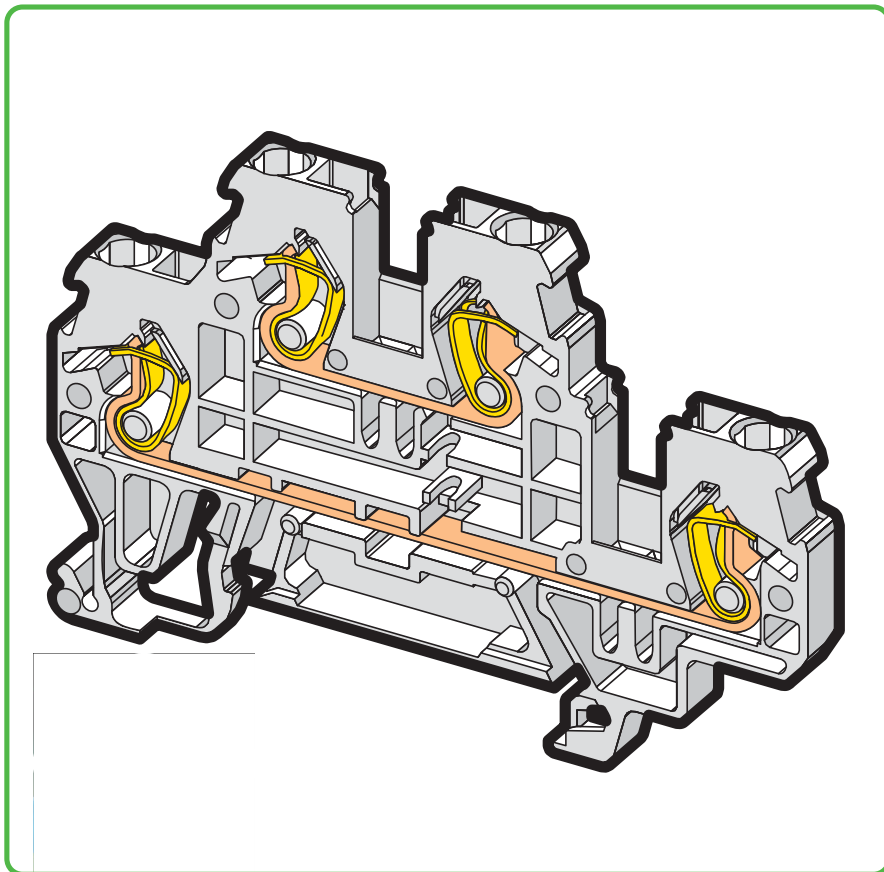

Protective warning marker

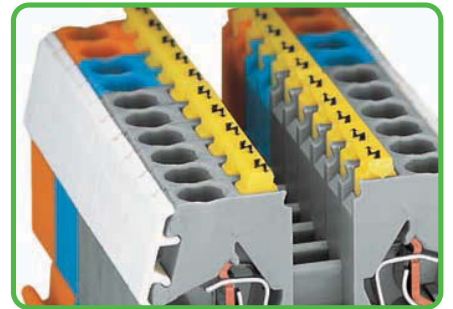

Protective warning markers (280-405), with black high-voltage symbols.

Marking

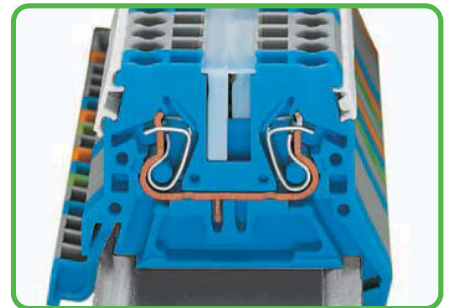

Marking the clamping unit via WMB Multi marking system or miniature WSB Quick marking system.

Space saver

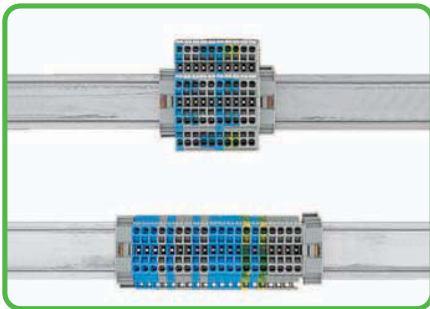

Save 50% of rail space when using double-deck terminal blocks.

Space saver

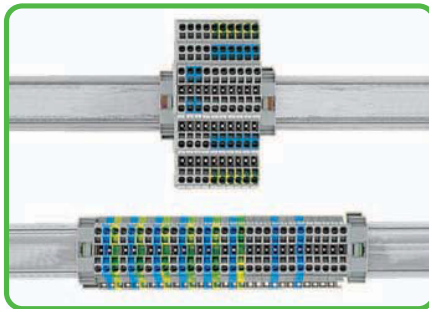

Save 67% of rail space when using triple-deck terminal blocks.

Marking Strips

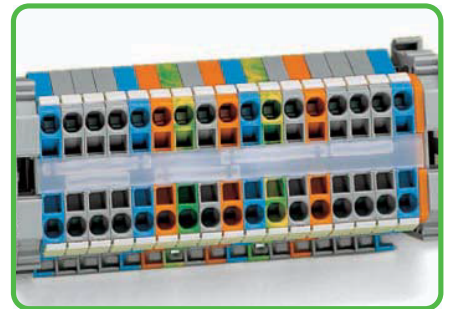

Transparent marker strips (note: Jumpers below may be visible).

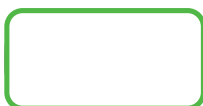

fine-stranded,
tip-bonded

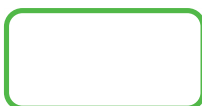

fine-stranded,
with ferrule ①
(gas-tight crimped)

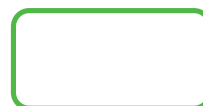

fine-stranded,
with pin terminal
(gas-tight crimped)

Triple-Deck Terminal Blocks 2.5 mm² (4 mm² "f-st") 870 Series



0.08 - 2.5 (4" f-st") mm ² ① 500 V/6 kV/3 ② I _N 24 A	AWG 28 - 12 300 V, 20 A:	0.08 - 2.5 (4" f-st") mm ² ① 500 V/6 kV/3 ② I _N 24 A	AWG 28 - 12 300 V, 20 A:
Terminal block width 5 mm / 0.197 in 6 - 7 mm / 0.26 in ③		Terminal block width 5 mm / 0.197 in 6 - 7 mm / 0.26 in ③	

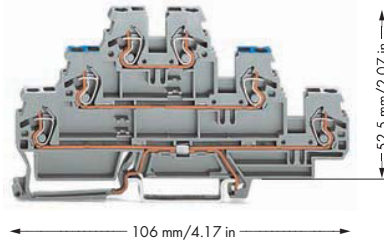
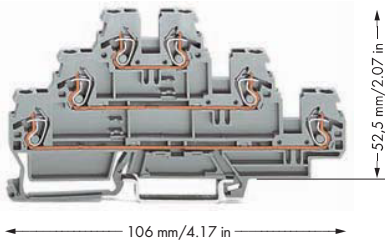

- ① Max. insulation diameter: 4.4 mm
- ② 500 V = rated voltage
6 kV = rated surge voltage
3 = pollution degree
(also see Section 14)
- ③ Strip length, see packaging or instructions.
- ④ Suitable for Ex e II applications
0.2 mm² - 2.5 (4 "f-st") mm²/AWG 24 - 12
440 V, 18 A
Using push-in type jumper bars 1 to X, the maximum rated voltage is reduced to 275 V and the rated current to 13.5 A
(also see Section 14)
- ⑤ See application notes for:
Insulation stop, page 199

Item No.	Pack. Unit	Item No.	Pack. Unit		
Through/through/through terminal block, gray housing		Shield/through/through terminal block, gray housing			
○ L/L/L	870-551	50	○ Shield/N/L	870-558	50
○ L/L/N	870-553	50	○ Shield/L/L	870-559	50
Ground conductor/through/through terminal block, gray housing		Ground conductor/through/through terminal block, light gray housing			
○ PE/N/L	870-567	50	○ PE/L/L	870-577	50
○ PE/L/L	870-577	50			
Through/through/through terminal block, light gray housing		Ground conductor/through/through terminal block, light gray housing			
○ L/L/L ④	870-951	50	○ PE/L/L	870-957/999-950	50
Other terminal blocks with the same profile:					
Diode	870-590/281-410	Page 290			
LED	870-593/281-434	Page 291			

Accessories

WMB/Miniature WSB (see Section 13)	
End and intermediate plate, 2 mm thick	
	orange 870-569 50 (2x25)
	gray 870-568 50 (2x25)
Insulation stop,	
⑤	5 pcs/strip, 0.08 - 0.2 mm ² "s" (0.14 mm ² "f-st") white 280-470 200 (8x25)
⑤	5 pcs/strip, 0.25 - 0.5 mm ² light gray 280-471 200 (8x25)
⑤	5 pcs/strip, 0.75 - 1 mm ² dark gray 280-472 200 (8x25)
Push-in type jumper bar, insulated, I _N 18 A,	
	light gray
	2-way 870-402 200 (8x25)
	3-way 870-403 200 (8x25)
	4-way 870-404 200 (8x25)
	5-way 870-405 100 (4x25)
	6-way 870-406 100 (4x25)
	7-way 870-407 100 (4x25)
	8-way 870-408 100 (4x25)
	9-way 870-409 100 (4x25)
	10-way 870-410 100 (4x25)
Push-in type jumper bar, insulated, I _N 18 A,	
	light gray
	from 1 to 3 870-433 200 (8x25)
	from 1 to 4 870-434 200 (8x25)
	from 1 to 5 870-435 100 (4x25)
	from 1 to 6 870-436 100 (4x25)
	from 1 to 7 870-437 100 (4x25)
	from 1 to 8 870-438 100 (4x25)
	from 1 to 9 870-439 100 (4x25)
	from 1 to 10 870-440 100 (4x25)
Protective warning marker, with high-voltage symbol, black, for 5 terminal blocks	
	yellow 280-405 100 (4x25)
Marking strip, plain, 7.5 mm wide, 1 m/3'3" long	
	translucent 709-196 1

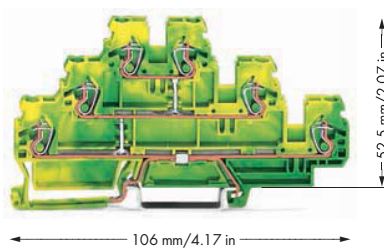
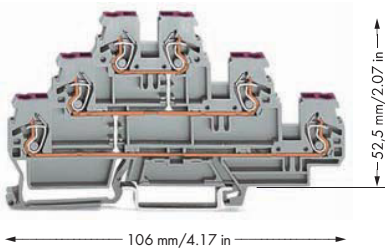

Item No.	Pack. Unit	Item No.	Pack. Unit		
6-conductor through terminal block, internal commoning, conductor entry position colored in violet, gray housing		6-conductor ground terminal block, internal commoning, green-yellow housing			
○ L	870-556	50	● PE	870-557	50