



## Main switchRear mounting

Part no.

T0-2-1/V/SVB

Article no.

043619



Powering Business Worldwide™

Front IP65

### Program

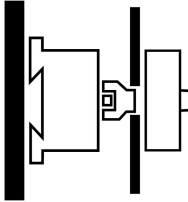
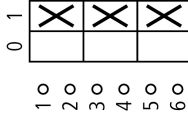
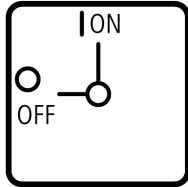
Range			Load current switches
Basic function			Main switches Maintenance switches Manual override switches
Part group reference (e.g. DIL)			T0
Design			Rear mounting
			
Protection type			Front IP65
Emergency stop			As an emergency switching off/emergency stop device With red rotary handle and yellow locking ring
Standards			According to IEC/EN 60204-1, VDE 0113 Part 1
Locking facility			Lockable in the 0 (Off) position without auxiliary contacts
Contact sequence			
Front plate no.			 <b>FS 908</b>
Main conducting paths			
No. of poles		M	3
Auxiliary contacts		N/O	0
		B	0
Max. motor rating			
AC-23A			
400/415 V 50-60 Hz	P	kW	6.5
Rated uninterrupted current	I <sub>u</sub>	A	20

### Approbationen

UL approval  
CSA approval  
Product Standards  
UL File No.  
UL CCN  
CSA File No.  
CSA Class No.  
NA Certification  
Specially designed for NA  
Suitable for  
Degree of Protection

Yes  
Yes  
UL 508; CSA-C22.2 No. 14-05; IEC/EN 60947-3; CE marking  
E36332  
NLRV  
12528  
3211-05  
UL listed, CSA certified  
Yes, in combination with "+NA" (105864)  
Branch circuits, suitable as motor disconnect  
IEC: IP65; UL/CSA Type 3R, 12

## General

Standards			IEC/EN 60947, VDE 0660, IEC/EN 60204, CSA, UL Switch-disconnectors to IEC/EN 60947-3 Load-break switches to IEC/EN 60947-3
Lifespan, mechanical	Operations	$\times 10^6$	0.5
Maximum operating frequency		Operations/h	3000
Climatic proofing			Damp heat, constant, to IEC 60068-2-78; Damp heat, cyclical, to IEC 60068-2-30
Ambient temperature		°C	
Open		°C	- 25 - 50
Enclosed		°C	- 25 - 40
Mounting position			As required
Mechanical shock resistance to IEC 60068-2-27	Half-sinusoidal shock 20 ms	g	> 15

## Contacts

Rated operational voltage	$U_e$	V AC	690
Rated impulse withstand voltage	$U_{imp}$	V AC	6000
Overtoltage category/pollution degree			III/3
Rated uninterrupted current	$I_u$	A	
open	$I_u$	A	20
Enclosed	$I_u$	A	20
Load rating with intermittent operation, class 12			
AB 25 % DF		$\times I_e$	2
AB 40 % DF		$\times I_e$	1.6
AB 60 % DF		$\times I_e$	1.3
Short-circuit rating			
Fuse		A gG/ gL	20
Rated short-time withstand current (1 s current)	$I_{cw}$	$A_{rms}$	320
Safe isolation to VDE 0106 Part 101 and Part 101/A1			
between the contacts		V AC	440
Switching angles		°	90 60 45 30
Contact units			11
Double-break contacts			max. 22
Current heat loss per contact at $I_e$		W	0.6

## Terminal capacities

Solid or stranded		mm <sup>2</sup>	1 x (1 - 2.5) 2 x (1 - 2.5)
Flexible with ferrule to DIN 46228		mm <sup>2</sup>	1 x (0.75 - 1.5) 2 x (0.75 - 1.5)
Terminal screw			M3.5
Tightening torque		Nm	1

## Switching capacity

AC		$\times U_s$	
Rated making capacity $\cos \varphi = 0.35$		A	130
Rated breaking capacity, motor load switch $\cos \varphi = 0.35$		A	
230 V		A	100
400 V		A	110
500 V		A	80
690 V		A	60
Rated operational current 440 V load-break switch AC-21A	$I_e$	A	20

Rating, AC-3 motor load switch	P	kW	
220/230 V	P	kW	3
230 V Star-delta	P	kW	4
400 V	P	kW	4
400 V Star-delta	P	kW	5.5
500 V	P	kW	5.5
500 V Star-delta	P	kW	7.5
690 V	P	kW	4
690 V Star-delta	P	kW	5.5
AC-23A Motor load switches (main switches maintenance switches)	P	kW	
230 V	P	kW	3.5
400 V	P	kW	6.5
500 V	P	kW	7.5
Rated operational current control switch AC-15			
230 V	$I_e$	A	6
400 V	$I_e$	A	4
500 V	$I_e$	A	2
DC		$x U_s$	
DC-1, Load-break switches L/R = 1 ms			
Rated operational current	$I_e$	A	10
Voltage per contact pair in series		V	60
DC-21A	$I_e$	A	
Rated operational current 240 V	$I_e$	A	1
240 V Contacts		Quantity	1
DC-23A, motor load switch L/R = 15 ms			
24 V			
Rated operational current	$I_e$	A	10
Contacts		Quantity	1
48 V			
Rated operational current	$I_e$	A	10
Contacts		Quantity	2
60 V			
Rated operational current	$I_e$	A	10
Contacts		Quantity	3
120 V			
Rated operational current	$I_e$	A	5
Contacts		Quantity	3
240 V			
Rated operational current	$I_e$	A	5
Contacts		Quantity	5
DC-13, Control switches L/R = 50 ms			
Rated operational current	$I_e$	A	10
Voltage per contact pair in series		V	32
Control circuit reliability at 24 V DC, 10 mA	Fault probability	$H_F$	$< 10^{-5}$ , < 1 fault in 100000 operations

### Auxiliary contacts

Standards According to IEC/EN 60204-1, VDE 0113 Part 1

### Notes

**Notes** Isolating characteristics as specified in IEC/EN 60947 for rated operating voltage  $U_e$  of up to 500 VAC  
The following applies for solid, multiwire, and flexible terminal capacities:  
If 2 conductors are being used, a max. difference of 2 cross-section categories is permissible

### Technical data according to ETIM 4.0

Number of auxiliary contacts as normally open contact			0
Number of auxiliary contacts as normally closed contact			0
Rated permanent current Iu		A	20

Number of poles		3
Conditioned rated short-circuit current Iq	kA	0
Degree of protection (IP), front side		IP55
Number of auxiliary contacts as change-over contact		0
Interlockable		YES
Motor drive integrated		No
Connection type main current circuit		Screw connection
Version as emergency stop installation		YES
Type of control element		Door coupling rotary drive
Version as main switch		YES
Version as switch disconnecter compact		No
Version as safety switch		No
Version as maintenance-/service switch		YES
Rated operation power at AC-23, 400V	kWh	6.5
Rated operation power AC-3, 400 V	kWh	4
Suitable for ground mounting		No
Suitable for front mounting		No
Suitable for front mounting center		No
Suitable for distribution board installation		No
Suitable for intermediate mounting		No
Max. rated operation voltage Ue AC	V	690
Motor drive optional		No
Voltage release optional		No
Device construction		Built-in device fixed built-in technique

## Characteristics

Form for ordering non-standard front plates

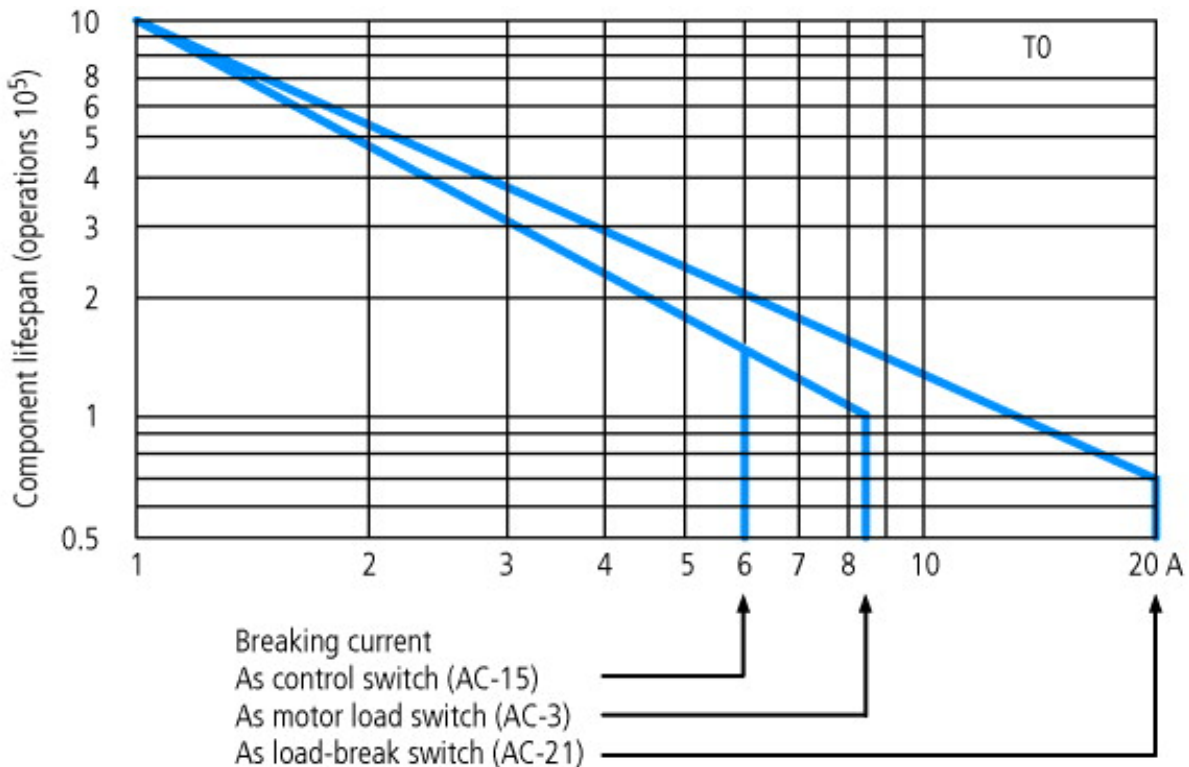

For utilisation category AC-4 (extreme load: 100 % inching, reversing or plugging)

The blocked rotor current of the motor should not exceed the rated current of the switch for AC-21A to ensure a reasonable device lifespan.

## Dimensions

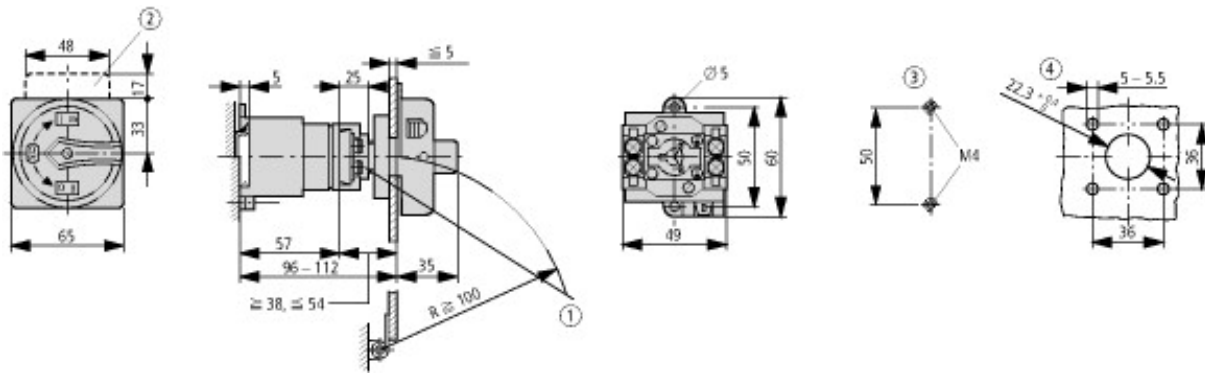

- ① Extension with ZVV-T0 + ZAV-T0 possible, max.  $4 \times 25 = 100$  mm
  - ② Label mount not included as standard
  - ③ Drilling dimensions base
  - ④ Drilling dimensions door
- One contact unit depth: 9.5 mm

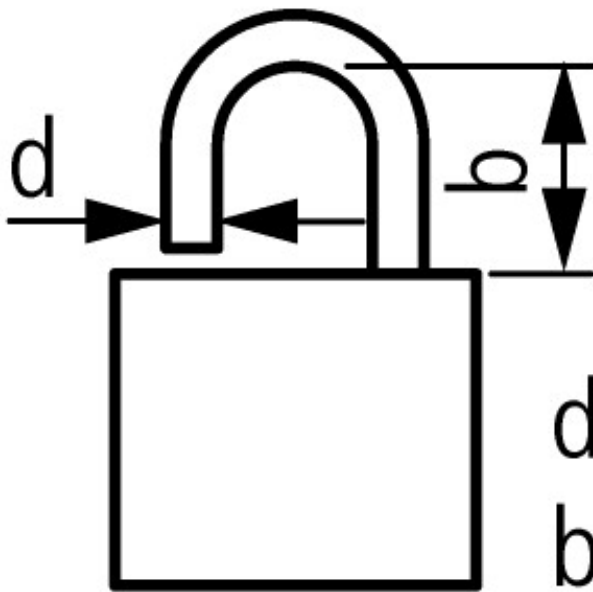

$$d = 4 - 8 \text{ mm}$$

$$b + d \leq 47 \text{ mm}$$

 3 padlocks

### Additional product information (links)

AWA1150-0587 (IL03801021Z) Cam switch	<a href="ftp://ftp.moeller.net/DOCUMENTATION/AWA_INSTRUCTIONS/05870709.pdf">ftp://ftp.moeller.net/DOCUMENTATION/AWA_INSTRUCTIONS/05870709.pdf</a>
<b>Engineering</b>	
Technical overview	<a href="ftp://ftp.moeller.net/DOCUMENTATION/PDF/GB/Ovt_t_p_Leistung_G.pdf">ftp://ftp.moeller.net/DOCUMENTATION/PDF/GB/Ovt_t_p_Leistung_G.pdf</a>
Key to part numbers, modular system	<a href="ftp://ftp.moeller.net/DOCUMENTATION/PDF/GB/Ovt_t_p_Typenschluessele_G.pdf">ftp://ftp.moeller.net/DOCUMENTATION/PDF/GB/Ovt_t_p_Typenschluessele_G.pdf</a>
Ordering of non-standard switches	<a href="ftp://ftp.moeller.net/DOCUMENTATION/PDF/GB/Bestellformulare_de.pdf">ftp://ftp.moeller.net/DOCUMENTATION/PDF/GB/Bestellformulare_de.pdf</a>