

*Changes for the Better*

 **mitsubishi**  
PROGRAMMABLE CONTROLLERS  
MELSEC-F

## USER'S MANUAL

FX2N-8AD Analog input block

**FX<sub>2N</sub>**

## **Foreword**

- This manual contains text, diagrams and explanations which will guide the reader in the correct installation and operation of the FX2N-8AD Analog input block. It should be read and understood before attempting to install or use the unit.
- Further information can be found in the FX0N/FX1N/FX2N/FX2NC/FX3U/FX3UC Series Hardware Manual for connecting main unit, and the FX Series Programming Manual(II).
- If in doubt at any stage of the installation of FX2N-8AD Analog input block always consult a professional electrical engineer who is qualified and trained to the local and national standards that applies to the installation site.
- If in doubt about the operation or use of FX2N-8AD Analog input block please consult the nearest Mitsubishi Electric distributor.
- This manual is subject to change without notice.

# FX2N-8AD Analog input block

## USER'S MANUAL

Manual number : JY992D86001

Manual revision : F

Date : September 2008

This manual confers no industrial property rights or any rights of any other kind, nor does it confer any patent licenses. Mitsubishi Electric Corporation cannot be held responsible for any problems involving industrial property rights which may occur as a result of using the contents noted in this manual.



## **Guidelines for the Safety of the User and Protection of the FX2N-8AD Analog input block.**

This manual provides information for the use of the FX2N-8AD Analog input block. The manual has been written to be used by trained and competent personnel. The definition of such a person or persons is as follows:

- a) Any engineer who is responsible for the planning, design and construction of automatic equipment using the product associated with this manual, should be of a competent nature, trained and qualified to the local and national standards required to fulfill that role. These engineers should be fully aware of all aspects of safety with regards to automated equipment.
- b) Any commissioning or service engineer must be of a competent nature, trained and qualified to the local and national standards required to fulfill that job. These engineers should also be trained in the use and maintenance of the completed product. This includes being completely familiar with all associated documentation for said product. All maintenance should be carried out in accordance with established safety practices.
- c) All operators of the completed equipment (see Note) should be trained to use this product in a safe manner in compliance to established safety practices. The operators should also be familiar with documentation which is associated with the actual operation of the completed equipment.

**Note :** The term ‘completed equipment’ refers to a third party constructed device which contains or uses the product associated with this manual.

## Notes on the Symbols Used in this Manual

At various times throughout this manual certain symbols will be used to highlight points which are intended to ensure the users personal safety and protect the integrity of equipment. Whenever any of the following symbols are encountered its associated note must be read and understood. Each of the symbols used will now be listed with a brief description of its meaning.

### Hardware Warnings



1) Indicates that the identified danger **WILL** cause physical and property damage.



2) Indicates that the identified danger could **POSSIBLY** cause physical and property damage.



3) Indicates a point of further interest or further explanation.

### Software Warnings



4) Indicates special care must be taken when using this element of software.



5) Indicates a special point which the user of the associate software element should be aware.



6) Indicates a point of interest or further explanation.

- Under no circumstances will Mitsubishi Electric be liable responsible for any consequential damage that may arise as a result of the installation or use of this equipment.
- All examples and diagrams shown in this manual are intended only as an aid to understanding the text, not to guarantee operation. Mitsubishi Electric will accept no responsibility for actual use of the product based on these illustrative examples.
- Please contact a Mitsubishi Electric distributor for more information concerning applications in life critical situations or high reliability.





Guideline.....	iii
1. Introduction .....	1-1
2. External Dimensions .....	2-1
3. Part Name .....	3-1
4. Installation .....	4-1
5. Connection to PLC .....	5-1
6. Wiring .....	6-1
6.1 Caution.....	6-1
7. Specifications .....	7-1
8. Buffer Memory (BFM).....	8-1
8.1 Buffer Memories (BFM) lists .....	8-3
8.2 Details of buffer memories .....	8-13
8.2.1 BFM #0, #1: Specifies input mode. ....	8-13
8.2.2 BFM #2 to BFM #9: Number of times of averaging .....	8-15
8.2.3 BFM #10 to BFM #17: Channel data.....	8-17
8.2.4 BFM #19: Disables setting change.....	8-17
8.2.5 BFM #20: Initializes functions.....	8-17
8.2.6 BFM #21: Writes I/O characteristics.....	8-18
8.2.7 BFM #22: Sets convenient functions.....	8-19
8.2.8 BFM #24: Specifies high-speed conversion channel .....	8-20
8.2.9 BFM #26: Upper/lower limit value error status .....	8-21
8.2.10 BFM #27: A/D data sudden change detection status .....	8-22
8.2.11 BFM #28: Scale over status .....	8-23
8.2.12 BFM #29: Error status .....	8-25
8.2.13 BFM #30: Model code .....	8-26

8.2.14	BFM #32: Operating time .....	8-26
8.2.15	BFM#33 disconnection detection (Only goods: since V1.10).....	8-27
8.2.16	BFM #41 to BFM #48: Offset data BFM #51 to BFM #58: Gain data.....	8-28
8.2.17	BFM #61 to BFM #68: Addition data .....	8-30
8.2.18	BFM #71 to BFM #78: Lower limit, error set value BFM #81 to BFM #88: Upper limit, error set value .....	8-31
8.2.19	BFM #91 to BFM #98: Sudden change detection set value .....	8-33
8.2.20	BFM #99: Clears upper/lower limit value error and sudden change detection error .....	8-35
8.2.21	BFM #101 to BFM #108: Peak value (minimum value) BFM #111 to BFM #118: Peak value (maximum value).....	8-36
8.2.22	BFM #109: Peak value reset flag (minimum value) BFM #119: Peak value reset flag (maximum value).....	8-37
8.2.23	BFM #198: Data history sampling time .....	8-38
8.2.24	BFM #199: Resets or stops data history .....	8-40
8.2.25	BFM #200 to BFM #3399: Data history .....	8-41
9.	Adjustment of I/O Characteristics.....	9-1
9.1	Standard I/O characteristics.....	9-2
9.2	Adjustment of I/O characteristics .....	9-7
10.	Example program.....	10-1
Appendix A		
	Associated Manuals List.....	A-1

## 1. Introduction

The FX<sub>2N</sub>-8AD analog input block (hereafter referred to as "FX<sub>2N</sub>-8AD") converts 8 points of analog input values (voltage input, current input and temperature input) into digital values, and transfers them to the PLC main unit.

The FX<sub>2N</sub>-8AD can be connected to FX<sub>0N</sub>/FX<sub>1N</sub>/FX<sub>2N</sub>/FX<sub>2NC</sub>/FX<sub>3U</sub>/FX<sub>3UC</sub> Series PLC.

1) Analog inputs can be selected from the voltage input, the current input and the thermocouple input (temperature input) by the input mode setting by the TO instruction given by the PLC main unit and the connection method.

At this time, a different analog input can be selected for each channel.

2) The voltage input can be selected within the range from -10 to +10 V. The current input can be selected within the range from -20 to +20 mA and from +4 to +20 mA. The input characteristics can be adjusted for each channel (except while the analog value direct display is used).

The thermocouple input can be selected among the K type, J type and T type. (The input characteristics cannot be adjusted when the thermocouple input is used.)

3) The resolution is 0.63 mV ( $20\text{ V} \times 1/32,000$ ) or 2.50 mV ( $20\text{ V} \times 1/8,000$ ) when the voltage input is used, 2.50  $\mu\text{A}$  ( $40\text{ mA} \times 1/16,000$ ) or 5.00  $\mu\text{A}$  ( $40\text{ mA} \times 1/8,000$ ) when the current input is used, and 0.1 °C when the thermocouple input is used.

- 4) Up to two FX2N-8AD units can be connected to FX0N main unit, FX0N extension unit, FX1N main unit.

Up to eight FX2N-8AD units can be connected to the FX2N/FX3U/FX3UC<sup>\*1</sup> Series PLC.

Up to four FX2N-8AD units can be connected to the FX2NC Series PLC.

(For connection to the FX2NC Series PLC, FX2NC-CNV-IF is required.)

(For connection to the FX3UC Series PLC, FX3UC-1PS-5V or FX2NC-CNV-IF is required.)

Data transfer with the PLC is performed to buffer memories of the FX2N-8AD by FROM/TO instructions.

\*1 Up to seven FX2N-8AD units can be connected to the FX3UC-32MT-LT PLC.

## 2. External Dimensions

Figure 2.1: External Dimensions

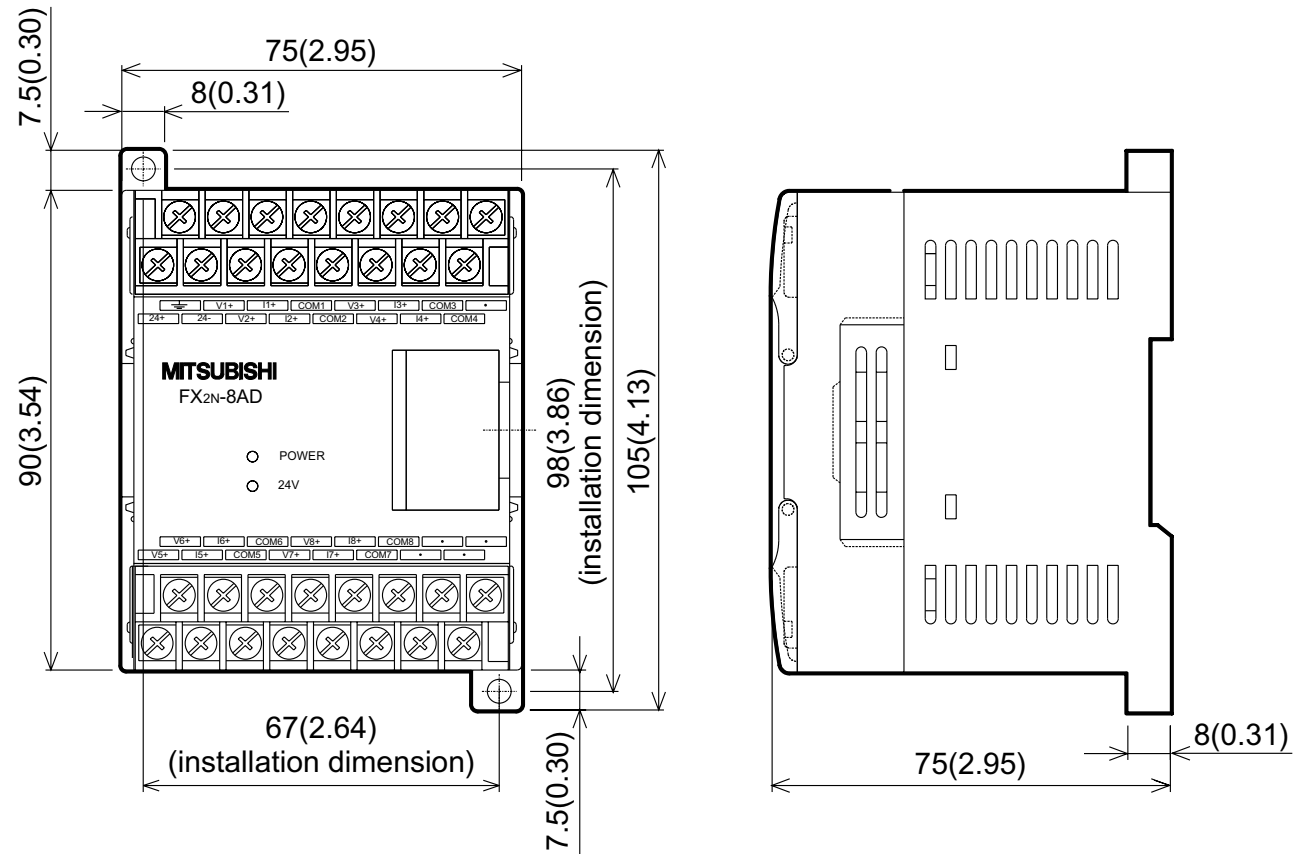

Dimensions: mm(inch)  
 Mass(Weight): 0.3 kg(0.66 lbs)

# MEMO

### 3. Part Name

**Figure 3.1: Part name**

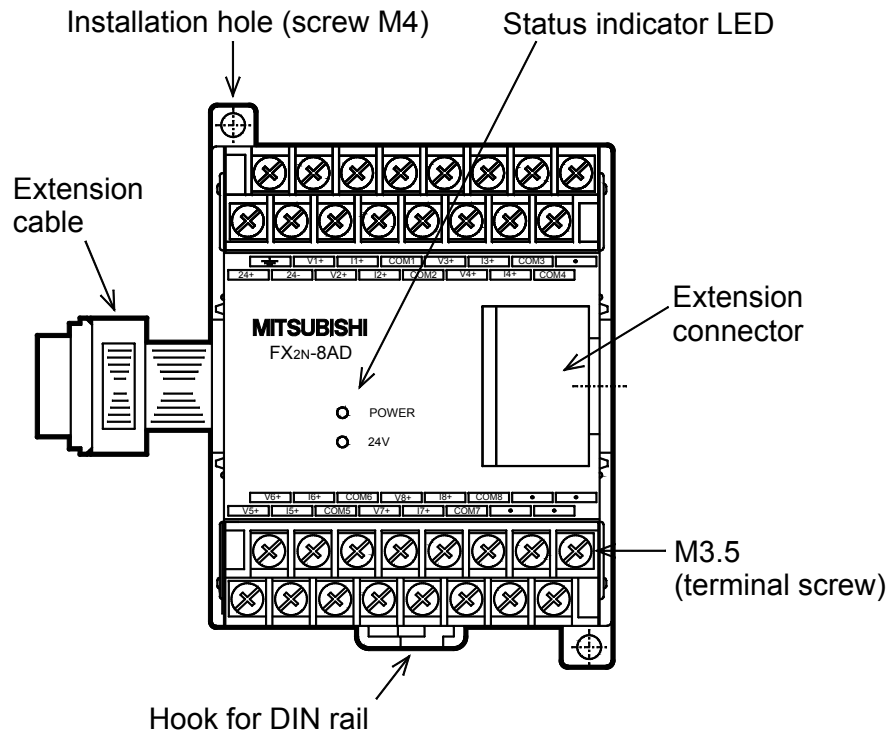

**Terminal arrangement**

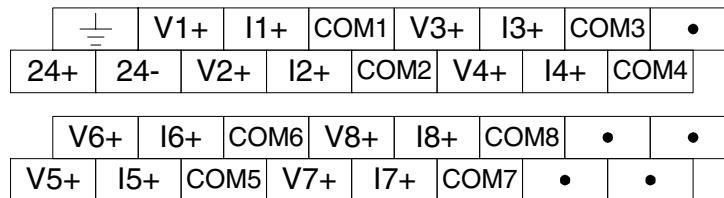

**Table 3.1: Status indicator LED**

Indication	Description
POWER	Lit while 5 V power is normally supplied from PLC.
24 V	Lit while 24 V power is normally supplied to “24+” and “24-” terminals of FX <sub>2N</sub> -8AD.V

- For wiring, refer to Section 6.
- Never perform wiring to • terminals.

# MEMO



## 4. Installation

Install the FX<sub>2N</sub>-8AD to the right side of a main unit, extension unit, extension block or special block of the FX<sub>0N</sub>/FX<sub>1N</sub>/FX<sub>2N</sub>/FX<sub>2NC</sub>/FX<sub>3U</sub>/FX<sub>3UC</sub> Series PLC.

The FX<sub>2N</sub>-8AD can be installed with a DIN rail (DIN46277 of 35 mm in width) or directly installed with screws M4. For the details, refer to the handy manual supplied together with the PLC main unit.)

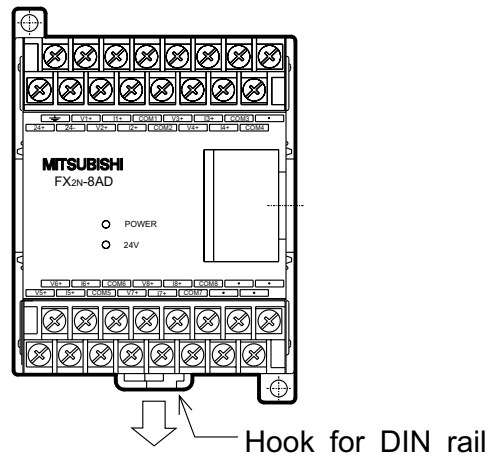
**Figure 4.1: Installation with DIN rail**

- The FX<sub>2N</sub>-8AD can be installed on a DIN rail (DIN46277) of 35 mm in width as it is. For removal, pull down on the DIN rail mounting hook, then remove the FX<sub>2N</sub>-8AD.

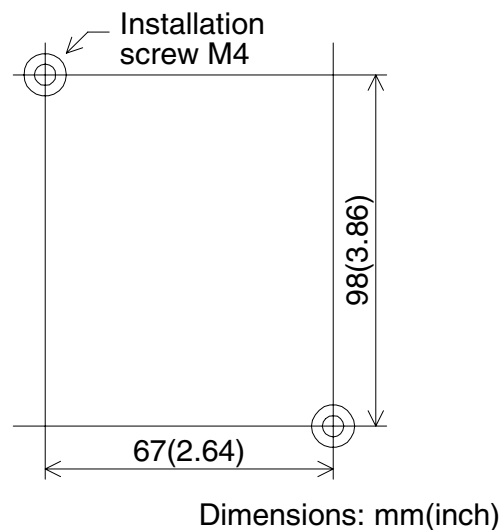
**Figure 4.2: Direct installation**

- The FX<sub>2N</sub>-8AD can be installed directly by inserting screws (M4) into installation holes. For the pitch and the position of installation holes, refer to the figure on the left.

## 5. Connection to PLC

Connect the FX<sub>2N</sub>-8AD to the right side of a main unit, extension unit or extension block of FX<sub>0N</sub>/FX<sub>1N</sub>/FX<sub>2N</sub>/FX<sub>2NC</sub>/FX<sub>3U</sub>/FX<sub>3UC</sub> Series PLC with an extension cable.

For connection to a main unit or extension block of the FX<sub>2NC</sub> Series PLC, FX<sub>2NC</sub>-CNV-IF is required.

For connection to a main unit or extension block of the FX<sub>3UC</sub> Series PLC, FX<sub>3UC</sub>-1PS-5V or FX<sub>2NC</sub>-CNV-IF is required.

Please check power supply availability to determine the number of FX<sub>2N</sub>-8AD blocks that can be connected to the FX<sub>0N</sub>/FX<sub>1N</sub>/FX<sub>2N</sub>/FX<sub>2NC</sub>/FX<sub>3U</sub>/FX<sub>3UC</sub> PLCs.

A unit No. 0 to 7 is automatically assigned to each special unit or special block connected to a PLC main unit from the one nearest to the main unit.\*<sup>1</sup>

The data is read from and written to the FX<sub>2N</sub>-8AD by FROM/TO instructions given by the main unit.

\*<sup>1</sup> Because the unit No.0 is assigned to the built-in CC-Link/LT master in the FX<sub>3UC</sub>-32MT-LT, unit numbers assigned to special extension units/blocks begins with No.1.

# MEMO

## 6. Wiring

### 6.1 Caution



- 1) Do not lay signal cable near to high voltage power cable or house them in the same trunking duct. Effects of noise or surge induction may occur. Keep signal cables a safe distance of more than 100 mm (3.94") from these power cables.
- 2) The terminal screws of the FX<sub>2</sub>N-8AD are M3.5 (0.14"), therefore crimp style terminals (see drawing) suitable for use with these screws should be fitted to the cable for wiring.

**Figure 6.1: Crimp Terminals**

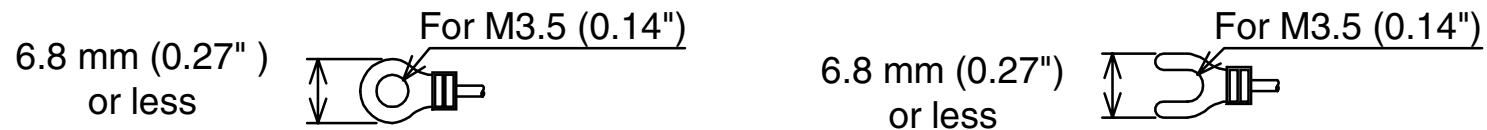

- 3) The terminal tightening torque is 0.5 to 0.8 N·m. Tighten securely to avoid malfunction.
- 4) Cut off all phases of power source before installation or performing wiring work in order to avoid electric shock or damage of product.
- 5) Replace the provided terminal cover before supplying power and operating the unit after installation or wiring work in order to avoid electric shock.

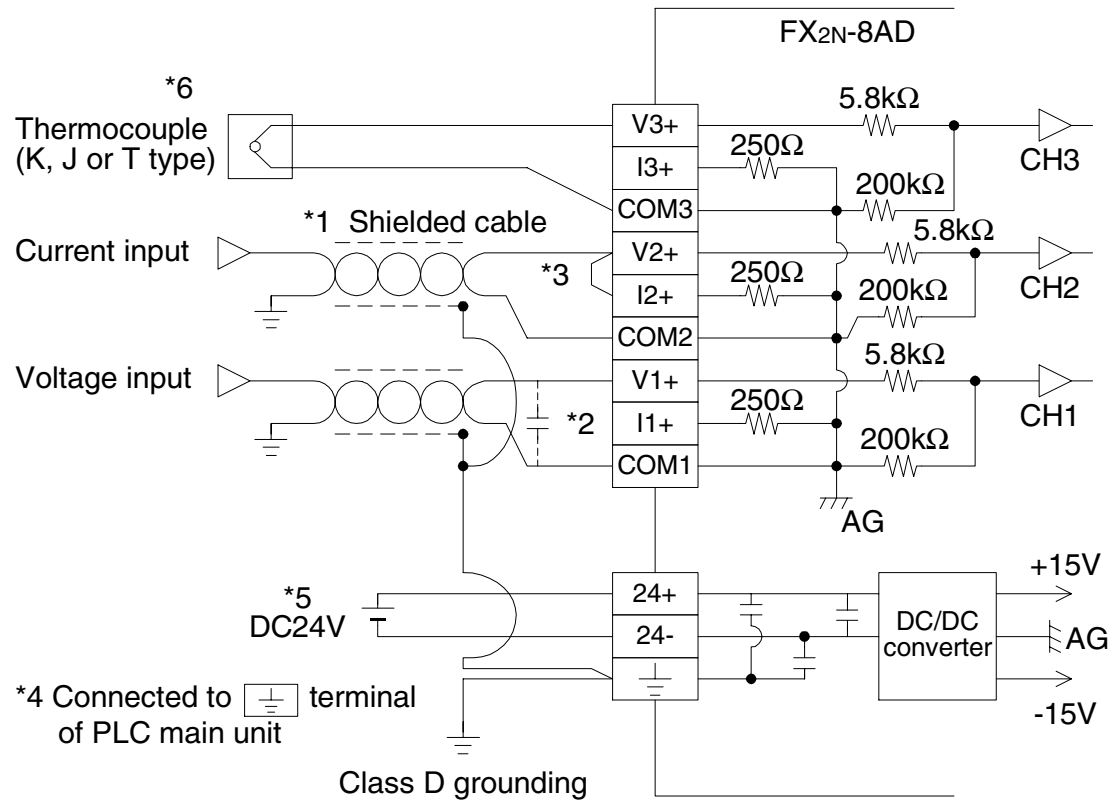

**Figure 6.2: Wiring**

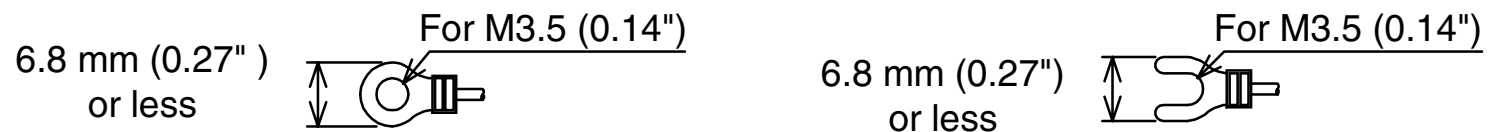

Note: Use solderless terminals of the following size (M3.5).  
Tighten them securely at the tightening torque of 0.5 to 0.8 N•m.

**Figure 6.3: Crimp Terminals**



- \*1 Use a two-core, twisted, shielded cable for the analog input line, and separate it from other power lines or a lines easily induced.
- \*2 If there is voltage ripple in the input or there is noise in the external wiring, connect a capacitor of approximately 0.1 to 0.47  $\mu\text{F}$ , 25 V.
- \*3 For the current input, make sure to short-circuit the “VO+” terminal and the “IO+” terminal (O: input channel No.).
- \*4 Make sure to connect the  terminal to the  terminal of the PLC main unit to which Class D grounding (100  $\Omega$  or less) is performed.
- \*5 The 24 V DC service power supply of the PLC is also available.
- \*6 Use an isolated type thermocouple.
  - When using the thermocouple input, use compensating conductors suitable to the thermocouple.
  - Never perform wiring to  terminals.
  - For the terminal arrangement, refer to Section 3.
- \*Compensating Lead Wire
  - To a wire resistance 10( $\Omega$ ), Compensating Lead Wire gives approx. 0.12C° higher than the actual temperature.
  - For accurate measuring, minus this temperature difference off from the measured value.
  - Check the wire resistance of Compensating Lead Wire before use.
  - A long Compensating Lead Wire is highly susceptible to Noise. Check that the Compensating Lead Wire is shorter than 100m.

# MEMO



## 7. Specifications

**Table 7.1: General specifications**

Item	Specifications
Ambient temperature range	0 to +55 °C during operation, -20 to +70 °C during storage
Ambient humidity	35 to 85 % RH during operation (Dew condensation shall not be allowed.)
Vibration resistance	Frequency 10 to 57 Hz, half amplitude 0.075 mm, 57 to 150 Hz, acceleration 9.8 m/s <sup>2</sup> , 10 times in each of X, Y and Z directions (80 min. in each direction) (For product installed with DIN rail: Frequency 10 to 57 Hz, half amplitude 0.035 mm, 57 to 150 Hz, acceleration 4.9 m/s <sup>2</sup> )
Impact resistance	147 m/s <sup>2</sup> for 11 ms, 3 times in each of X, Y and Z directions with half-sine pulses
Noise resistance	By noise simulator of noise voltage 1,000 Vp-p, noise width 1 μs and frequency 30 to 100 Hz
Withstand voltage	500 V AC for 1 min (between analog input terminal and each terminal of PLC main unit)
Insulation resistance	5 MΩ or more by 500 V DC Megger (between all terminals as a whole and case)
Operating atmosphere	Corrosive gas and much dusts shall not be detected.
Working altitude	<2000m*1

\*1 If the pressure is higher than the atmospheric pressure, do not use FX2N-8AD.  
Malfunctions may occur.

**Table 7.2: Power supply specifications**

Item	Specifications
Interface driving power supply	24 V DC $\pm$ 10%, 80 mA (maximum), supplied via terminal from outside
CPU driving power supply	5 V DC, 50 mA, supplied via extension cable from PLC main unit

**Table 7.3: Performance specifications**

Item	Specifications
Conversion speed	<ul style="list-style-type: none"> <li>• When only voltage input and current input are used 500 <math>\mu</math>s x Number of used channels</li> <li>• When thermocouple input is used for 1 or more channels Channel for voltage/current input: 1 ms x Number of used channels Channel for thermocouple input: 40 ms x Number of used channels (Number of used channels indicates number of all channels used for voltage input, current input or thermocouple input.)</li> </ul>
Insulation method	Photocoupler insulates analog input area from PLC. DC/DC converter insulates power supply from analog I/O. Channels are not insulated each other.
Number of occupied I/O points	8 points (including input points and output points)
Applicable PLC	FX0N/FX1N/FX2N/FX2NC/FX3U/FX3UC Series PLC (For connection to FX2NC Series PLC, FX2NC-CNV-IF is required.) (For connection to FX3UC Series PLC, FX3UC-1PS-5V or FX2NC-CNV-IF is required.)
Built-in memory	EEPROM

**Table 7.4: Voltage/current input specifications**

Item	Voltage input	Current input
Analog input range	-10 to +10 V DC (input resistance: 200 k $\Omega$ ) Adjustment is enabled in following condition: Offset value: -10 to +9 V Gain value: 10 V or less "Gain - Offset": > 1 V (Resolution is constant.) However, change is disabled while analog value direct display is used. Maximum absolute input: $\pm 15$ V	-20 to +20 mA DC, +4 to +20 mA DC (input resistance: 250 $\Omega$ ) Adjustment is enabled in following condition: Offset value: -20 to +17 mA Gain value: 30 mA or less "Gain - Offset": > 3 mA (Resolution is constant.) However, change is disabled while analog value direct display is used. Maximum absolute input: $\pm 30$ mA
Digital output	Signed 16-bit binary	Signed 16-bit binary
Resolution	<ul style="list-style-type: none"> <li>• 0.63 mV (20 V <math>\times</math> 1/32000)</li> <li>• 2.5mV (20 V <math>\times</math> 1/8000)</li> </ul>	<ul style="list-style-type: none"> <li>• 2.50 <math>\mu</math>A (40 mA <math>\times</math> 1/16,000) during input of -20 to +20 mA</li> <li>• 5.00 <math>\mu</math>A (40 mA <math>\times</math> 1/8,000) during input of -20 to +20 mA</li> <li>• 2.00 <math>\mu</math>A (16 mA <math>\times</math> 1/8,000) during input of +4 to +20 mA</li> <li>• 4.00 <math>\mu</math>A (16 mA <math>\times</math> 1/4,000) during input of +4 to +20 mA</li> </ul>
Total accuracy	Ambient temperature: 25 $^{\circ}$ C $\pm$ 5 $^{\circ}$ C $\pm 0.3\%$ ( $\pm 60$ mV) against full scale 20 V Ambient temperature: 0 to +55 $^{\circ}$ C $\pm 0.5\%$ ( $\pm 100$ mV) against full scale 20 V	Ambient temperature: 25 $^{\circ}$ C $\pm$ 5 $^{\circ}$ C $\pm 0.3\%$ ( $\pm 120$ $\mu$ A) against full scale 40 mA +4 to +20mA input is same ( $\pm 120$ $\mu$ A) Ambient temperature: 0 to +55 $^{\circ}$ C $\pm 0.5\%$ ( $\pm 200$ $\mu$ A) against full scale 40 mA +4 to +20mA input is same ( $\pm 200$ $\mu$ A)

**Table 7.5: Thermocouple input specifications (JIS C 1602-1995)**

Item		K type thermocouple	J type thermocouple	T type thermocouple
Analog input range		-100 to 1200 °C -148 to 2192 °F	-100 to 600 °C -148 to 1112 °F	-100 to 350 °C -148 to 662 °F
Digital output		Signed 16-bit binary	Signed 16-bit binary	Signed 16-bit binary
Resolution		0.1 °C or 0.1 °F	0.1 °C or 0.1 °F	0.1 °C or 0.1 °F
Total accuracy	Less than V1.10	Ambient temperature: 0 to 55 °C ± 1 % Against full scale (-100 °C to 1200 °C / -148 °F to 2192 °F) However, 0 °C to 1000 °C / 32 °F to 1832 °F of K type and 25 °C to 600 °C / 77 °F to 600 °F of J type are 0.5 %.		
	V1.10 or more	Ambient temperature: 0 to 55 °C ± 0.5% against a full scale. ± 6.5°C / ± 11.7 °F when it uses K type ± 3.5°C / ± 6.3 °F when it uses J type		Ambient temperature: 0 to 55 °C ± 0.7% (± 3.15°C / ± 5.67 °F) against a full scale.

- For the I/O characteristics of the voltage/current/thermocouple input, refer to Section 9.
- FX<sub>2N</sub>-8AD is from production goods (SERIAL 0Z\*\*\*\*) to V1.10 in December, 2000.

## 8. Buffer Memory (BFM)



### Caution

- 1) Do not access the buffer memory of “Reserved” (BFM #18, #23, #25, #31, #33 to #40, #49 to 50, #59, #60, #69, #70, #79, #80, #89, #90, #99, #100, #120 to #197) by the FROM/TO instruction. There is a possibility to cause abnormal operation of the FX2N-8AD if accessing these buffer memories.

Data transfer between the FX2N-8AD and the PLC main unit is performed through buffer memories (hereafter referred to as "BFM") of the FX2N-8AD.

Each BFM consists of 1 word, 16 bits. The BFM No. 0 to 3399 and a function are assigned to each BFM.

Use FROM/TO instructions to read and write the data between the BFM and the PLC.

When the power is turned on from off, the initial value is written to each BFM. When you would like to use different contents of the BFM, create a program for the PLC so that the desired contents are written to the BFM every time the power of the PLC is turned on.

(The contents stored in BFM #0, #1, #19, #22, #24, #41 to #48 and #51 to #58 are stored in the built-in EEPROM, and held against power failure.)

## 8.1 Buffer Memories (BFM) lists

**Table 8.1: BFM Lists**

BFM No.	Description	Hold against power failure	Initial value
#0	Specifies input mode of CH1 to CH4.	○	H0000 at shipment
#1	Specifies input mode of CH5 to CH8.	○	H0000 at shipment
#2	Number of times of averaging of CH1 Setting range: 1 to 4,095 times	—	1
#3	Number of times of averaging of CH1 Setting range: 1 to 4,095 times	—	1
#4	Number of times of averaging of CH1 Setting range: 1 to 4,095 times	—	1
#5	Number of times of averaging of CH1 Setting range: 1 to 4,095 times	—	1
#6	Number of times of averaging of CH1 Setting range: 1 to 4,095 times	—	1
#7	Number of times of averaging of CH1 Setting range: 1 to 4,095 times	—	1
#8	Number of times of averaging of CH1 Setting range: 1 to 4,095 times	—	1
#9	Number of times of averaging of CH8 Setting range: 1 to 4,095 times	—	1
#10	CH1 data (immediate data or average data)	—	—
#11	CH2 data (immediate data or average data)	—	—
#12	CH3 data (immediate data or average data)	—	—
#13	CH4 data (immediate data or average data)	—	—
#14	CH5 data (immediate data or average data)	—	—
#15	CH6 data (immediate data or average data)	—	—
#16	CH7 data (immediate data or average data)	—	—
#17	CH8 data (immediate data or average data)	—	—

**Table 8.1: BFM Lists**

BFM No.	Description	Hold against power failure	Initial value
#18	Reserved	—	—
#19	Disables setting change of I/O characteristics (BFM #0, BFM #1, BFM #21) and convenient functions (BFM #22). Disables change.: K2, Enables change.: K1	○	K1 at shipment
#20	Initializes functions. (Initializes functions at K1, then returns automatically to K0 after initialization is completed.)	—	K0
#21	Writes I/O characteristics. (Returns automatically to K0 after write of offset/gain value is finished.)	—	K0
#22	Sets convenient functions (data addition, upper/lower limit value detection, sudden change detection and peak value hold).	○	K1 at shipment
#23	Reserved	—	K0
#24	Specifies high-speed conversion channel. Setting range: K0 to K8	○	K1 at shipment
#25	Reserved	—	K0
#26	Upper/lower limit value error status (valid while BFM #22 b1 is ON)	—	K0
#27	A/D data sudden change detection status (valid while BFM #22 b2 is ON)	—	K0
#28	Scale over status and disconnection detection	—	K0
#29	Error status	—	K0
#30	Model code (K2050)	—	K2050
#31	Reserved	—	—



**Table 8.1: BFM Lists**

BFM No.	Description	Hold against power failure	Initial value
#32	Operating time 0 to 64,800 (s) After that, 64,800 is kept. Measurement starts when power is turned on, and measured value is reset when power is turned off.	—	K0
#33	Thermo-couple disconnection detection(V1.10 or higher.) It executes the disconnection detection with K1. It automatically returns to K0 after it completes it.	—	K0
• • •	Reserved	—	—
#41	CH1 offset data (mV or $\mu$ A)	○	K0 at shipment
#42	CH2 offset data (mV or $\mu$ A)	○	K0 at shipment
#43	CH3 offset data (mV or $\mu$ A)	○	K0 at shipment
#44	CH4 offset data (mV or $\mu$ A)	○	K0 at shipment
#45	CH5 offset data (mV or $\mu$ A)	○	K0 at shipment
#46	CH6 offset data (mV or $\mu$ A)	○	K0 at shipment
#47	CH7 offset data (mV or $\mu$ A)	○	K0 at shipment
#48	CH8 offset data (mV or $\mu$ A)	○	K0 at shipment
• • •	Reserved	—	—
#51	CH1 gain data (mV or $\mu$ A)	○	K5000 at shipment
#52	CH2 gain data (mV or $\mu$ A)	○	K5000 at shipment

**Table 8.1: BFM Lists**

BFM No.	Description	Hold against power failure	Initial value
#53	CH3 gain data (mV or $\mu$ A)	○	K5000 at shipment
#54	CH4 gain data (mV or $\mu$ A)	○	K5000 at shipment
#55	CH5 gain data (mV or $\mu$ A)	○	K5000 at shipment
#56	CH6 gain data (mV or $\mu$ A)	○	K5000 at shipment
#57	CH7 gain data (mV or $\mu$ A)	○	K5000 at shipment
#58	CH8 gain data (mV or $\mu$ A)	○	K5000 at shipment
#59 #60	Reserved	—	—
#61	CH1 addition data Setting range: -16,000 to +16,000 (valid while BFM #22 b0 is ON)	—	K0
#62	CH2 addition data Setting range: -16,000 to +16,000 (valid while BFM #22 b0 is ON)	—	K0
#63	CH3 addition data Setting range: -16,000 to +16,000 (valid while BFM #22 b0 is ON)	—	K0
#64	CH4 addition data Setting range: -16,000 to +16,000 (valid while BFM #22 b0 is ON)	—	K0
#65	CH5 addition data Setting range: -16,000 to +16,000 (valid while BFM #22 b0 is ON)	—	K0
#66	CH6 addition data Setting range: -16,000 to +16,000 (valid while BFM #22 b0 is ON)	—	K0
#67	CH7 addition data Setting range: -16,000 to +16,000 (valid while BFM #22 b0 is ON)	—	K0

**Table 8.1: BFM Lists**

<b>BFM No.</b>	<b>Description</b>	<b>Hold against power failure</b>	<b>Initial value</b>
#68	CH8 addition data Setting range: -16,000 to +16,000 (valid while BFM #22 b0 is ON)	—	K0
• • •	Reserved	—	—
#71	CH1 lower limit value error set value (valid while BFM #22 b1 is ON)	—	Minimum digital value inside input range
#72	CH2 lower limit value error set value (valid while BFM #22 b1 is ON)	—	Minimum digital value inside input range
#73	CH3 lower limit value error set value (valid while BFM #22 b1 is ON)	—	Minimum digital value inside input range
#74	CH4 lower limit value error set value (valid while BFM #22 b1 is ON)	—	Minimum digital value inside input range
#75	CH5 lower limit value error set value (valid while BFM #22 b1 is ON)	—	Minimum digital value inside input range
#76	CH6 lower limit value error set value (valid while BFM #22 b1 is ON)	—	Minimum digital value inside input range
#77	CH7 lower limit value error set value (valid while BFM #22 b1 is ON)	—	Minimum digital value inside input range
#78	CH8 lower limit value error set value (valid while BFM #22 b1 is ON)	—	Minimum digital value inside input range
• • •	Reserved	—	—

**Table 8.1: BFM Lists**

BFM No.	Description	Hold against power failure	Initial value
#81	CH1 upper limit value error set value (valid while BFM #22 b1 is ON)	—	Maximum digital value inside input range
#82	CH2 upper limit value error set value (valid while BFM #22 b1 is ON)	—	Maximum digital value inside input range
#83	CH3 upper limit value error set value (valid while BFM #22 b1 is ON)	—	Maximum digital value inside input range
#84	CH4 upper limit value error set value (valid while BFM #22 b1 is ON)	—	Maximum digital value inside input range
#85	CH5 upper limit value error set value (valid while BFM #22 b1 is ON)	—	Maximum digital value inside input range
#86	CH6 upper limit value error set value (valid while BFM #22 b1 is ON)	—	Maximum digital value inside input range
#87	CH7 upper limit value error set value (valid while BFM #22 b1 is ON)	—	Maximum digital value inside input range
#88	CH8 upper limit value error set value (valid while BFM #22 b1 is ON)	—	Maximum digital value inside input range
⋮	Reserved	—	—
#91	CH1 sudden change detection set value Setting range: 1 to 50% of full scale (valid while BFM #22 b2 is ON)	—	5% of full scale
#92	CH2 sudden change detection set value Setting range: 1 to 50% of full scale (valid while BFM #22 b2 is ON)	—	5% of full scale

**Table 8.1: BFM Lists**

BFM No.	Description	Hold against power failure	Initial value
#93	CH3 sudden change detection set value Setting range: 1 to 50% of full scale (valid while BFM #22 b2 is ON)	—	5% of full scale
#94	CH4 sudden change detection set value Setting range: 1 to 50% of full scale (valid while BFM #22 b2 is ON)	—	5% of full scale
#95	CH5 sudden change detection set value Setting range: 1 to 50% of full scale (valid while BFM #22 b2 is ON)	—	5% of full scale
#96	CH6 sudden change detection set value Setting range: 1 to 50% of full scale (valid while BFM #22 b2 is ON)	—	5% of full scale
#97	CH7 sudden change detection set value Setting range: 1 to 50% of full scale (valid while BFM #22 b2 is ON)	—	5% of full scale
#98	CH8 sudden change detection set value Setting range: 1 to 50% of full scale (valid while BFM #22 b2 is ON)	—	5% of full scale
#99	Clearness of upper and lower limit value error and sudden change detection error	—	K0
⋮	Reserved	—	—
#101	CH1 peak value (minimum value) (valid while BFM #22 b3 is ON)	—	Refer to 8.2.21.
#102	CH2 peak value (minimum value) (valid while BFM #22 b3 is ON)	—	
#103	CH3 peak value (minimum value) (valid while BFM #22 b3 is ON)	—	
#104	CH4 peak value (minimum value) (valid while BFM #22 b3 is ON)	—	
#105	CH5 peak value (minimum value) (valid while BFM #22 b3 is ON)	—	
#106	CH6 peak value (minimum value) (valid while BFM #22 b3 is ON)	—	

**Table 8.1: BFM Lists**

BFM No.	Description	Hold against power failure	Initial value
#107	CH7 peak value (minimum value) (valid while BFM #22 b3 is ON)	—	Refer to 8.2.21.
#108	CH8 peak value (minimum value) (valid while BFM #22 b3 is ON)	—	
#109	Peak value (minimum value) reset flag	—	K0
#110	Unusable	—	Refer to 8.2.21.
#111	CH1 peak value (maximum value) (valid while BFM #22 b3 is ON)	—	
#112	CH2 peak value (maximum value) (valid while BFM #22 b3 is ON)	—	
#113	CH3 peak value (maximum value) (valid while BFM #22 b3 is ON)	—	
#114	CH4 peak value (maximum value) (valid while BFM #22 b3 is ON)	—	
#115	CH5 peak value (maximum value) (valid while BFM #22 b3 is ON)	—	
#116	CH6 peak value (maximum value) (valid while BFM #22 b3 is ON)	—	
#117	CH7 peak value (maximum value) (valid while BFM #22 b3 is ON)	—	
#118	CH8 peak value (maximum value) (valid while BFM #22 b3 is ON)	—	
#119	Peak value (maximum value) reset flag	—	K0
⋮	Reserved	—	—
#198	Data history sampling time (valid only in channels for which number of times of averaging (BFM #2 to #9) is set to "1") Setting range: 0 to 30,000 ms	—	K0

**Table 8.1: BFM Lists**

BFM No.	Description	Hold against power failure	Initial value	
#199	Resets or stops data history. (valid only in channels for which number of times of averaging (BFM #2 to #9) is set to "1")	—	K0	
#200	CH1 data history (1st value)	Data history sampling is valid only in channels for which number of times of averaging (BFM #2 to #9) is set to "1".	K0	
#201	CH1 data history (2nd value)		K0	
#202	CH1 data history (3rd value)		K0	
⋮			—	
#599	CH1 data history (400th value)		K0	
#600	CH2 data history (1st value)		K0	
#601	CH2 data history (2nd value)		K0	
#602	CH2 data history (3rd value)		K0	
⋮			—	
#999	CH2 data history (400th value)		K0	
#1000	CH3 data history (1st value)		K0	
#1001	CH3 data history (2nd value)		K0	
#1002	CH3 data history (3rd value)		K0	

**Table 8.1: BFM Lists**

BFM No.	Description		Hold against power failure	Initial value
• • •		Data history sampling is valid only in channels for which number of times of averaging (BFM #2 to #9) is set to "1".	—	
#3397	CH8 data history (398th value)		—	K0
#3398	CH8 data history (399th value)		—	K0
#3399	CH8 data history (400th value)		—	K0



## 8.2 Details of buffer memories

### 8.2.1 BFM #0, #1: Specifies input mode.

Specify the input mode of CH1 to CH4 by writing a numeric value to BFM #0. Specify the input mode of CH5 to CH8 by writing a numeric value to BFM #1.

In the input mode specification, each BFM is expressed in a 4-digit hexadecimal code, and each channel No. is assigned to each digit. Specify a numeric value 0 to F in each digit for each channel.

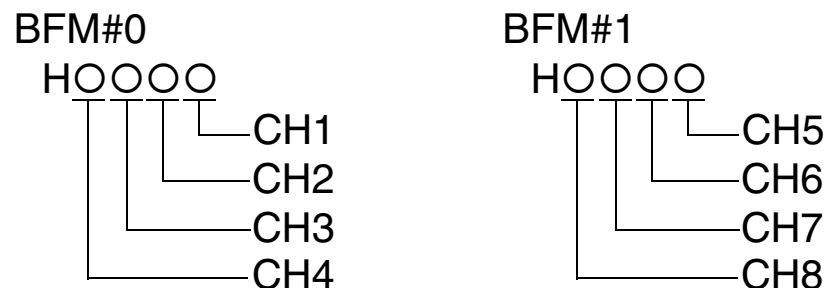

- =0: Voltage input mode (-10 to +10 V), resolution 0.63 mV (20 V x 1/32,000)
- =1: Voltage input mode (-10 to +10 V), resolution 2.50 mV (20 V x 1/8,000)
- =2: Voltage input mode, analog value direct display (-10,000 to +10,000), resolution 1 mV
- =3: Current input mode (4 to 20 mA), resolution 2.00  $\mu$ A (16 mA x 1/8,000)
- =4: Current input mode (4 to 20 mA), resolution 4.00  $\mu$ A (16 mA x 1/4,000)
- =5: Current input mode, analog value direct display (4,000 to 20,000), resolution 2.00  $\mu$ A
- =6: Current input mode (-20 to +20 mA), resolution 2.50  $\mu$ A (40 mA x 1/16,000)
- =7: Current input mode (-20 to +20 mA), resolution 5.00  $\mu$ A (40 mA x 1/8,000)

○=8: Current input mode, analog value direct display (-20,000 to +20,000), resolution 2.50  $\mu$ A  
○=9: Thermocouple input mode, K type, Celsius display (-100 to +1,200°C), resolution 0.1°C  
○=A: Thermocouple input mode, J type, Celsius display (-100 to +600°C), resolution 0.1°C  
○=B: Thermocouple input mode, T type, Celsius display (-100 to +350°C), resolution 0.1°C  
○=C: Thermocouple input mode, K type, Fahrenheit display (-148 to +2,192°F), resolution 0.1°F  
○=D: Thermocouple input mode, J type, Fahrenheit display (-148 to +1,112°F), resolution 0.1°F  
○=E: Thermocouple input mode, T type, Fahrenheit display (-148 to +662°F), resolution 0.1°F  
○=F: Input channel release (unusable)

- The input characteristics are automatically changed in accordance with the setting of BFM #0 and BFM #1.  
(When the voltage input mode or the current input mode is selected, the input characteristics can be changed. However, when the analog value direct display is selected, the input characteristics cannot be changed.)
- The setting "release of all input channels (unusable)" is not available.
- It takes approximately 5 seconds to change the input mode (BFM #0, BFM #1) (to change each set value).  
Assue the time interval of 5 seconds or more after change of the input mode until execution of write of each setting (TO instruction).

### 8.2.2 BFM #2 to BFM #9: Number of times of averaging

When using BFM #10 to #17 as the average data, write the number of times of averaging to BFM #2 to BFM #9.

The setting range of the number of times of averaging is 1 to 4,095.

However, when you set the number of times of averaging to "1", the immediate data (current value) is stored in BFM #10 to BFM #17.

When you set the number of times of averaging to "0" or a smaller value, "0" is written. When you set the number of times of averaging to "4,096" or a larger value, "4,096" is written. In either case, a number of times of averaging setting error (BFM #29 b10) occurs.

The initial value is "1".

### Update of average data

- When the number of times of averaging (BFM #2 to BFM #9) is set to "400" or less, the average (BFM #10 to BFM #17) is updated every time the A/D conversion processing is performed.

At this time, the average is always calculated by sampling of the A/D conversion values as many as the set number of times of averaging from the latest one.

The update time is as follows:

Average data update time = (A/D conversion time) x Number of channels

- When the number of times of averaging (BFM #2 to BFM #9) is set to "401" or more, the average (BFM #10 to BFM #17) is updated every time A/D conversion is performed by as many as the set number of times of averaging.

The update time is as follows:

Average data update time = (A/D conversion time) x Number of channels x Number of times of averaging

In either case above, until the number of times of A/D conversion reaches the set number of times of averaging for the first time, the average at each time point is stored in BFM #10 to BFM #17.

### 8.2.3 BFM #10 to BFM #17: Channel data

The A/D conversion data of each channel is written to BFM #10 to BFM #17.

You can select the immediate (current value) data or the average data by setting the number of times of averaging (BFM #2 to BFM #9) described above.

### 8.2.4 BFM #19: Disables setting change

BFM #19 enables or disables the setting change of the I/O characteristics (BFM #0, BFM #1, BFM #21), the convenient functions (BFM #22) and the high-speed conversion channel (BFM #24).

K1: Enables change (selected at shipment from factory).

K2: Disables change.

### 8.2.5 BFM #20: Initializes functions

BFM #20 initializes all data stored in BFM #0 to BFM #3399, and sets the FX<sub>2</sub>N-8AD to the status at shipment from the factory.

By initialization, the input characteristics are reset to the values set at shipment from the factory (voltage input, offset value K0, gain value K5000).

K0: Normal

K1: Executes initialization.

(Writes K1, then returns automatically to K0 when initialization is completed.)

### 8.2.6 BFM #21: Writes I/O characteristics

Each channel No. is assigned to the lower eight bits of BFM #21.

When a bit is set to ON, the offset data (BFM #41 to BFM #48) and the gain data (BFM #51 to BFM #58) of the assigned channel No. are written to the built-in memory (EEPROM), and become valid.

You can give the write command to two or more channels at a time. (When you input "HFF", all channels are written.)

When write is completed, BFM #21 returns automatically to K0.

BFM21

b15, b14, b13, b12, b11, b10, b9, b8,	<u>b7</u> , <u>b6</u> , <u>b5</u> , <u>b4</u> , <u>b3</u> , <u>b2</u> , <u>b1</u> , <u>b0</u>
	CH8 CH7 CH6 CH5 CH4 CH3 CH2 CH1
Invalid	

### 8.2.7 BFM #22: Sets convenient functions

The functions described below are assigned to b0 to b3 of BFM #22. When a bit is set to ON, the assigned function becomes valid.

When a bit is set to OFF, the assigned function becomes invalid.

#### b0: Data addition function

The data (BFM #10 to BFM #17), the peak value (BFM #101 to BFM #108, BFM #111 to BFM #118) and the data history (BFM #200 to BFM #3399) of each channel become the measured value added by the addition data (BFM #61 to BFM #68).

When using this function, write the value added by the addition data (BFM #61 to BFM #68) to the lower limit value error set value (BFM #71 to BFM #78) and the upper limit value error set value (BFM #81 to BFM #88).

The addition data (BFM #61 to BFM #68) is not added to the scale over data (BFM #28).

#### b1: Upper/lower limit value detection function

When the A/D conversion data of each channel is outside the range from the lower limit value error set value (BFM #71 to BFM #78) to the upper limit value error set value (BFM #81 to BFM #88), the result is written to the upper/lower limit value error status (BFM #26).

#### b2: Sudden change detection function

When the data (BFM #10 to BFM #17) of each channel is updated, if the difference between the previous value and the new value is larger than the sudden change detection set value (BFM #91 to BFM #98), the result is written to the sudden change detection status (BFM #27).

#### b3: Peak value hold function

The minimum value of the data (BFM #10 to BFM #17) of each channel is written to BFM #101 to BFM #108, and the maximum value is written to BFM #111 to BFM #118.

### 8.2.8 BFM #24: Specifies high-speed conversion channel

When using only the voltage input mode and the current input mode, you can improve the A/D conversion timing (to 1/4 of the normal timing) for only one channel among CH1 to CH8. However, the conversion timing becomes slower in other channels (to twice of the normal timing).

To select a channel, write "K1" (for CH1) to "K8" (for CH8) to BFM #24.  
(When you write "K0", the high-speed conversion function is not available.)

Example: When BFM #24 is set to "K1"

Conversion channel

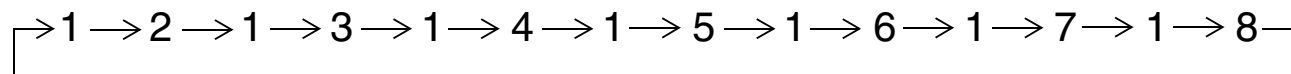

Conversion timing of CH1:  $500 \mu\text{s} \times 2 = 1 \text{ ms}$

Conversion timing of other channels:  $500 \mu\text{s} \times 2 \times 8 \text{ (CH)} = 8 \text{ ms}$

(Usual conversion timing of each channel:  $500 \mu\text{s} \times 8 \text{ (CH)} = 4 \text{ ms}$ )

- When the thermocouple input mode is used in one or more channels, the high-speed conversion function is not available.



### 8.2.9 BFM #26: Upper/lower limit value error status

When you use the upper/lower limit value detection function (BFM #22 b1), the detection result is written to BFM #26.

The lower limit value error or the upper limit value error of each channel is assigned to each bit of BFM #26. When the data (BFM #10 to BFM #17) of each channel is outside the range from the lower limit value error set value (BFM #71 to BFM #78) to the upper limit value error set value (BFM #81 to BFM #88), the corresponding bit turns ON.

Once a bit turns ON, it remains ON until it is reset by BFM #99 or the power is turned off.

Even while an upper/lower limit value error is detected, the data (BFM #10 to BFM #17) of each channel is continuously updated.

**Table 8.2: Bit assignment in BFM #26**

Bit No.	Channel No.	Description
b0	CH1	Lower limit value error
b1		Upper limit value error
b2	CH2	Lower limit value error
b3		Upper limit value error
b4	CH3	Lower limit value error
b5		Upper limit value error
b6	CH4	Lower limit value error
b7		Upper limit value error

Bit No.	Channel No.	Description
b8	CH5	Lower limit value error
b9		Upper limit value error
b10	CH6	Lower limit value error
b11		Upper limit value error
b12	CH7	Lower limit value error
b13		Upper limit value error
b14	CH8	Lower limit value error
b15		Upper limit value error

### 8.2.10 BFM #27: A/D data sudden change detection status

When you use the sudden change detection function (BFM #22 b2), the detection result is written to BFM #27.

The sudden change detection + direction or the sudden change detection - direction of each channel is assigned to each bit of BFM #27. When the data (BFM #10 to BFM #17) of each channel is updated, if the difference between the previous value and the new value is larger than the sudden change detection set value (BFM #91 to BFM #98), the corresponding bit turns ON. At this time, when the new value is larger than the previous value, a bit for the + direction turns ON. when the new value is smaller than the previous value, a bit for the - direction turns ON. Once a bit turns ON, it remains ON until it is reset by BFM #99 or the power is turned off. Even while a sudden change error is detected, the data (BFM #10 to BFM #17) of each channel is continuously updated.

**Table 8.3: Bit assignment in BFM #27**

Bit No.	Channel No.	Description
b0	CH1	Sudden change error in - direction
b1		Sudden change error in + direction
b2	CH2	Sudden change error in - direction
b3		Sudden change error in + direction
b4	CH3	Sudden change error in - direction
b5		Sudden change error in + direction
b6	CH4	Sudden change error in - direction
b7		Sudden change error in + direction

Bit No.	Channel No.	Description
b8	CH5	Sudden change error in - direction
b9		Sudden change error in + direction
b10	CH6	Sudden change error in - direction
b11		Sudden change error in + direction
b12	CH7	Sudden change error in - direction
b13		Sudden change error in + direction
b14	CH8	Sudden change error in - direction
b15		Sudden change error in + direction

### 8.2.11 BFM #28: Scale over status

When the analog input value of each channel is outside the range in which input is available, the result is written to BFM #28.

**Table 8.4: Range in which input is available**

Voltage input mode	Current input mode <sup>*1</sup>	Thermocouple input mode		
		K type	J type	T type
- 10.240V to 10.235V	- 20.480mA to 20.470mA	-100 °C to 1200 °C -148 °F to 2192 °F	-100 °C to 600 °C -148 °F to 1112 °F	-100 °C to 350 °C -148 °F to 662 °F

\*1 The above table shows the available input range in the current input mode. A scale over status bit turns ON when the analog input value is as follows:

Input mode 3 to 5 : - 40.8mA or less, 40.8mA or more

Input mode 6 to 8 : - 1.25mA or less, 40.8mA or more

Use the upper / lower limit detection function to detect the scale over status in the current input mode.

Once a bit turns ON, it remains ON until it is overwritten with the OFF status by the TO instruction given by the PLC main unit or the power is turned off.

Even while a scale over error is detected, the data (BFM #10 to BFM #17) of each channel is continuously updated.

**Table 8.5: Bit assignment in BFM #28**

Bit No.	Channel No.	Description
b0	CH1	Scale over: Less than lower limit
b1		Scale over: More than upper limit and disconnection detection
b2	CH2	Scale over: Less than lower limit
b3		Scale over: More than upper limit and disconnection detection
b4	CH3	Scale over: Less than lower limit
b5		Scale over: More than upper limit and disconnection detection
b6	CH4	Scale over: Less than lower limit
b7		Scale over: More than upper limit and disconnection detection
b8	CH5	Scale over: Less than lower limit
b9		Scale over: More than upper limit and disconnection detection
b10	CH6	Scale over: Less than lower limit
b11		Scale over: More than upper limit and disconnection detection
b12	CH7	Scale over: Less than lower limit
b13		Scale over: More than upper limit and disconnection detection
b14	CH8	Scale over: Less than lower limit
b15		Scale over: More than upper limit and disconnection detection

### 8.2.12 BFM #29: Error status

The error information is assigned to each bit of BFM #29.

**Table 8.6: Bit assignment in BFM #29**

Bit No.	Assignment	Description
b0	Error detected	b0 is ON while either one among b1 to b4 is ON.
b1	Offset/gain set value error	Offset/gain value is outside setting range. Set a correct value.
b2	Power error	24 V power is not normally supplied. Check wiring and supply voltage.
b3	Hardware error	FX <sub>2N</sub> -8AD may have failed. Contact Mitsubishi Electric System Service nearest to you.
b4	A/D conversion value error	A/D conversion value is abnormal. Using scale over data (BFM #28), check channel in which error has occurred.
b5	Thermocouple being warmed up	This bit is ON for 20 minutes after power is turned on.
b6	BFM read/write disabled	This bit is ON during input characteristics change processing. While this bit is ON, correct A/D data cannot be read from or written to BFM.
b7	—	—
b8	Set value error detected	This bit is ON while either bit among b9 to b15 is ON.

**Table 8.6: Bit assignment in BFM #29**

Bit No.	Assignment	Description
b9	Input mode setting error	Input mode (BFM #0, BFM #1) is incorrectly set. Set it within range from 0 to F.
b10	Number of times of averaging setting error	Number of times of averaging is incorrectly set. Set it within range from 1 to 4,095.
b11	—	—
b12	Sudden change detection set value error	Sudden change detection set value is incorrect. Set a correct value.
b13	Upper/lower limit value error set value error	Upper/lower limit value error set value is incorrect. Set a correct value.
b14	High-speed conversion channel setting error	High-speed conversion channel is incorrectly set. Set it within range from 0 to 8.
b15	Addition data setting error	Addition data is incorrectly set. Set it within range from -16,000 to +16,000.

**8.2.13 BFM #30: Model code**

BFM #30 stores the fixed value "K2050".

**8.2.14 BFM #32: Operating time**

BFM #32 stores the continuous operating time of the FX<sub>2N</sub>-8AD.

Measurement starts when the power is turned on, and the measured value is reset when the power is turned off.

The measurement range is from 0 to 64,800 (s). After that, 64,800 is kept.

### 8.2.15 BFM#33 disconnection detection (Only goods: since V1.10).

It does the disconnection detection of all channels used by writing K1 in BFM#33 in the thermo-couple input mode (Set it by BFM#1 and # 0).

It executes the disconnection detection only once, and the result is written in BFM#28.

(It turns on the odd number bit of the channel where the disconnection occurs. Refer to Table 8.5.)

When it completes the execution of the disconnection detection, K0 is automatically written in BFM#33.

Write K1 in BFM#33 regularly when you continuously execute the disconnection detection.

At this time, you should use the internal clock so that the interruption of the analog to digital conversion may increase when it does every operation execution.

It turns off POWER LED during the disconnection detection execution. (Blink when continuously executing it)

Program example

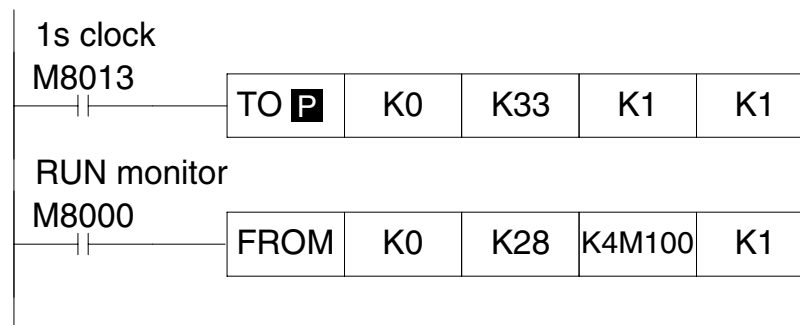

In the program of the following, when it detects the disconnection with each channel, it turns on the undermentioned supplementary Relay.

CH1:M101	CH5:M109
CH2:M103	CH6:M111
CH3:M105	CH7:M113
CH4:M107	CH8:M115

### 8.2.16 BFM #41 to BFM #48: Offset data BFM #51 to BFM #58: Gain data

Offset data : Analog input value when the digital value is "0"

Gain data : Analog input value when the digital value is as shown below

(The digital value varies depending on the setting of the input mode.)

#### Standard digital value of offset and gain in each input mode

(A number in the input mode column indicates a value set in BFM #0, BFM #1.)

**Table 8.7: Standard digital value**

Input mode (BFM #0, BFM #1)	0	1	2	3	4	5	6	7	8
Standard offset value	0	0	Unchange- able	0	0	Unchange- able	0	0	Unchange- able
Standard gain value	8000	2000	Unchange- able	8000	4000	Unchange- able	8000	4000	Unchange- able

- You can set the offset data and the gain data for each channel.
- Write the set value in the unit of "mV" for voltage input or "μA" for current input.
- You cannot change the input characteristics in the analog value direct display mode and the thermocouple input mode. (Even if you write a numeric value, it is ignored.)



**Initial offset/gain value** (Unit: mV for voltage input,  $\mu\text{A}$  for current input)

**Table 8.8: Initial offset/gain value**

Input mode (BFM #0, BFM #1)	0	1	2	3	4	5	6	7	8
Initial offset value	0	0	0	4000	4000	4000	0	0	0
Initial gain value	5000	5000	5000	20000	20000	20000	20000	20000	20000

**Setting range**

**Table 8.9: Setting range**

	Voltage input	Current input
Offset data	-1000 to +9000 (mV)	-2000 to +1700 ( $\mu\text{A}$ )
Gain data	Gain value - Offset value = 1,000 to 10,000 (mV)	Gain value - Offset value = 3,000 to 30,000 ( $\mu\text{A}$ )

However, the actual effective input range is "-10 to +10 V" or "-20 to +20 mA".

### 8.2.17 BFM #61 to BFM #68: Addition data

When you use the data addition function (BFM #22 b0), the data (BFM #10 to BFM #17), the peak value (BFM #101 to BFM #108, BFM #111 to BFM #118) and the data history (BFM #200 to BFM #999) of each channel become the measured value added by the addition data (BFM #61 to BFM #68).

When using the data addition function, write the value added by the addition data (BFM #61 to BFM #68) to the lower limit value error set value (BFM #71 to BFM #78) and the upper limit value error set value (BFM #81 to BFM #88).

#### Setting range:

-16,000 to +16,000

### 8.2.18 BFM #71 to BFM #78: Lower limit, error set value BFM #81 to BFM #88: Upper limit, error set value

When using the upper/lower limit value detection function (BFM #22 b1), write the lower limit value of each channel to BFM #71 to BFM #79 and the upper limit value of each channel to BFM #81 to BFM #88.

When using the data addition function (BFM #22 b0) together, write the value added by the addition data (BFM #61 to BFM #68) to BFM #71 to BFM #78 and BFM #81 to BFM #88.

#### Setting range

The setting range varies depending on the setting of the input mode (BFM #0, BFM #1).

The table below shows the setting range in each input mode. Write the set value in a digital value.

**Table 8.10: Setting range**

Input mode (BFM #0, BFM #1)	Setting range	Initial value	
		Lower limit	Upper limit
0: Voltage input mode (-10 to +10 V), resolution 10 V x 1/16,000	-16384 to 16383	-16384	16383
1: Voltage input mode (-10 to +10 V), resolution 10 V x 1/4,000	-4096 to 4095	-4096	4095
2: Voltage input mode, analog value direct display (-10,000 to +10,000)	-10200 to 10200	-10200	10200
3: Current input mode (4 to 20 mA), resolution 20 mA x 1/8,000	-1 to 8191	-1	8191
4: Current input mode (4 to 20 mA), resolution 20 mA x 1/4,000	-1 to 4095	-1	4095
5: Current input mode, analog value direct display (4,000 to 20,000)	3999 to 20400	3999	20400
6: Current input mode (-20 to +20 mA), resolution 20 mA x 1/8,000	-8192 to 8191	-8192	8191

**Table 8.10: Setting range**

Input mode (BFM #0, BFM #1)	Setting range	Initial value	
		Lower limit	Upper limit
7: Current input mode (-20 to +20 mA), resolution 20 mA x 1/4,000	-4096 to 4095	-4096	4095
8: Current input mode, analog value direct display (-20,000 to +20,000)	-20400 to 20400	-20400	20400
9: Thermocouple input mode (K type), Celsius display	-1000 to 12000	-1000	12000
A: Thermocouple input mode (J type), Celsius display	-1000 to 6000	-1000	6000
B: Thermocouple input mode (T type), Celsius display	-1000 to 3500	-1000	3500
C: Thermocouple input mode (K type), Farenheit display	-1480 to 21920	-1480	21920
D: Thermocouple input mode (J type), Farenheit display	-1480 to 11120	-1480	11120
E: Thermocouple input mode (T type), Farenheit display	-1480 to 6620	-1480	6620
F: Channel unusable	Invalid	-1	1

### 8.2.19 BFM #91 to BFM #98: Sudden change detection set value

When using the sudden change detection function (BFM #22 b2), write the set value to judge the sudden change.

When the data (BFM #10 to BFM #17) of each channel is updated, if the difference between the previous value and the new value is larger than the sudden change detection set value (BFM #91 to BFM #98), the result is written to the sudden change detection status (BFM #27).

#### Setting range

The setting range varies depending on the setting of the input mode (BFM #0, BFM #1).

The table below shows the setting range in each input mode.

Write the set value in a digital value.

**Table 8.11: Setting range**

Input mode (BFM #0, BFM #1)	Setting range	Initial value
0: Voltage input mode (-10 to +10 V), resolution 10 V x 1/16,000	1 to 16383	1600
1: Voltage input mode (-10 to +10 V), resolution 10 V x 1/4,000	1 to 4095	400
2: Voltage input mode, analog value direct display (-10,000 to +10,000)	1 to 10000	1000
3: Current input mode (4 to 20 mA), resolution 20 mA x 1/8,000	1 to 4095	400
4: Current input mode (4 to 20 mA), resolution 20 mA x 1/4,000	1 to 2047	200
5: Current input mode, analog value direct display (4,000 to 20,000)	1 to 8191	800
6: Current input mode (-20 to +20 mA), resolution 20 mA x 1/8,000	1 to 8191	800
7: Current input mode (-20 to +20 mA), resolution 20 mA x 1/4,000	1 to 4095	400
8: Current input mode, analog value direct display (-20,000 to +20,000)	1 to 20000	2000
9: Thermocouple input mode (K type), Celsius display	1 to 6500	650

**Table 8.11: Setting range**

Input mode (BFM #0, BFM #1)	Setting range	Initial value
A: Thermocouple input mode (J type), Celsius display	1 to 3500	350
B: Thermocouple input mode (T type), Celsius display	1 to 4500	450
C: Thermocouple input mode (K type), Farenheit display	1 to 11700	1170
D: Thermocouple input mode (J type), Farenheit display	1 to 6300	630
E: Thermocouple input mode (T type), Farenheit display	1 to 4050	405
F: Channel unusable	Invalid	0

### 8.2.20 BFM #99: Clears upper/lower limit value error and sudden change detection error

The commands to clear the lower limit value error, the upper limit value error and the sudden change detection error are assigned to the lower three bits of BFM #99.

When a bit is set to ON, the flag of the corresponding error status (BFM #26, BFM #27) is reset for all channels at a time.

After reset is finished, each bit of BFM #99 returns automatically to OFF.

You can set two or more clear commands to ON at a time.

**Table 8.12: Bit assignment in BFM #99**

Bit No.	Description
b0	Clears lower limit value error.
b1	Clears upper limit value error.
b2	Clears sudden change detection error.
b3 to b15	Unused

**8.2.21 BFM #101 to BFM #108: Peak value (minimum value)  
BFM #111 to BFM #118: Peak value (maximum value)**

When you use the peak value hold function (BFM #22 b3), one of the convenient functions, the minimum value of the data (BFM #10 to BFM #17) of each channel is written to BFM #101 to BFM #108, and the maximum value is written to BFM #111 to BFM #118.

When you use the data addition function (BFM #22 b0) together, the minimum/maximum measured value added by the addition data is written.

**Initial value**

When the peak hold function is not used: K0

When the peak hold function is used: Digital value when the power is turned on



### 8.2.22 BFM #109: Peak value reset flag (minimum value) BFM #119: Peak value reset flag (maximum value)

When you use the peak value hold function (BFM #22 b3), BFM #109 clears the peak value (minimum value) stored in BFM #101 to BFM #108, and BFM #119 clears the peak value (maximum value) stored in BFM #111 to BFM #118.

The channel No. to be reset is assigned to each bit of BFM #109 and BFM #119. When a bit is set to ON, the peak value of the assigned channel is cleared.

(You can set two or more bits to ON at a time.)

**Table 8.13: Bit assignment**

<b>BFM #109</b>	<b>Bit No.</b>	<b>b15 to b8</b>	<b>b7</b>	<b>b6</b>	<b>b5</b>	<b>b4</b>	<b>b3</b>	<b>b2</b>	<b>b1</b>	<b>b0</b>
	Channel No. (BFM No.)	Unusable	CH8 (#108)	CH7 (#107)	CH6 (#106)	CH5 (#105)	CH4 (#104)	CH3 (#103)	CH2 (#102)	CH1 (#101)
<b>BFM #119</b>	<b>Bit No.</b>	<b>b15 to b8</b>	<b>b7</b>	<b>b6</b>	<b>b5</b>	<b>b4</b>	<b>b3</b>	<b>b2</b>	<b>b1</b>	<b>b0</b>
	Channel No. (BFM No.)	Unusable	CH8 (#108)	CH7 (#107)	CH6 (#106)	CH5 (#105)	CH4 (#104)	CH3 (#103)	CH2 (#102)	CH1 (#101)

### 8.2.23 BFM #198: Data history sampling time

Set the data history sampling time.

BFM #198 is valid only in channels for which the number of times of averaging (BFM #2 to #9) is set to "1".

#### Setting range

0 to 30,000 ms

#### Sampling cycle

##### When only voltage input and current input are used

When the set value is "0" :  $500 \mu\text{s} \times \text{Number of effective channels}$

When the set value is "1" or more :  $\text{Set value (ms)} \times \text{Number of effective channels}$

##### When thermocouple input is used for one or more channels

Channel for voltage input or current input

When the set value is "0" or "1":  $1 \text{ ms} \times \text{Number of effective channels}$

When the set value is "2" or more:  $\text{Set value (ms)} \times \text{Number of effective channels}$

Channel for thermocouple input

When the set value is "0" to "39" :  $40 \text{ ms} \times \text{Number of effective channels}$

When the set value is "40" or more :  $\text{Set value (ms)} \times \text{Number of effective channels}$

**When the high-speed conversion mode is used (and only voltage input and current input are used)**

When the set value is "0" or "1"

Channel specified for high-speed conversion : 1 ms  
Other channels : 1 ms x Number of effective channels

When the set value is "2" or more

Channel specified for high-speed conversion : Set value (ms) x Number of effective channels  
Other channels : Set value (ms) x Number of effective channels x 2

- "Number of effective channels" indicates the number of all channels for which the number of times of averaging (BFM #2 to BFM #9) is set to "1" without regard to the input mode (voltage input, current input or thermocouple input).

### 8.2.24 BFM #199: Resets or stops data history

The data history reset function is assigned to the lower eight bits of BFM #199. The data history stop function is assigned to the upper eight bits of BFM #199.

Each function is valid only in channels for which the number of times of averaging (BFM #2 to #9) is set to "1".

#### Data history reset function

This function clears the sampled data history in each channel.

The channel No. to be reset is assigned to each of the lower eight bits of BFM #199.

When a bit is set to ON, the data history (all contents from the 1st value to the 400th value) of the assigned channel is cleared. (You can set two or more bits to ON at a time.)

When the clear operation is completed, each bit returns automatically to OFF.

**Table 8.14: Assignment of lower eight bits**

Bit No.	b7	b6	b5	b4	b3	b2	b1	b0
Channel No.	CH8	CH7	CH6	CH5	CH4	CH3	CH2	CH1

#### Data history stop function

This function stops temporarily sampling of the data history in the unit of channel.

The channel No. to be stopped temporarily is assigned to each of the upper eight bits of BFM #199.

When a bit is set to ON, sampling of the data history of the assigned channel is stopped temporarily. (You can set two or more bits to ON at a time.)

When a bit is set to OFF, sampling of the data history of the assigned channel restarts.

**Table 8.15: Assignment of upper eight bits**

Bit No.	b15	b14	b13	b12	b11	b10	b9	b8
Channel No.	CH8	CH7	CH6	CH5	CH4	CH3	CH2	CH1

### 8.2.25 BFM #200 to BFM #3399: Data history

The A/D conversion of each channel is sampled, and written to BFM #200 to BFM #3399. The table below shows the assignment of channel No. and BFM No. Data is stored in turn from the smallest BFM No.

Up to 400 values can be stored for each channel. When the number of values exceeds "400", the existing data is overwritten with new data from the smallest BFM No.

Data history sampling is valid only in channels for which the number of times of averaging (BFM #2 to #9) is set to "1".

**Table 8.16: Assignment of channel No. and BFM No.**

Channel No.	BFM No.				
	1st value	2nd value	3rd value	•••••	400th value
CH1	#200	#201	#202	•••••	#599
CH2	#600	#601	#602	•••••	#999
CH3	#1000	#1001	#1002	•••••	#1399
CH4	#1400	#1401	#1402	•••••	#1799
CH5	#1800	#1801	#1802	•••••	#2199
CH6	#2200	#2201	#2202	•••••	#2599
CH7	#2600	#2601	#2602	•••••	#2999
CH8	#3000	#3001	#3002	•••••	#3399

- If much data history is read at a time to the PLC main unit by one FROM instruction, a watch dog timer error occurs in the PLC main unit.  
In such a case, divide the required data history using many FROM instructions, and insert the WDT instruction (watch dog timer refresh instruction) after each FROM instruction.

# MEMO

## 9. Adjustment of I/O Characteristics

At the time of shipment from the factory, the FX<sub>2N</sub>-8AD has the standard I/O characteristics in accordance with each input mode (BFM #0, BFM #1).

In the voltage input mode and the current input mode, you can adjust the standard I/O characteristics for each channel. (You cannot adjust the standard I/O characteristics in the analog value direct output mode and the thermocouple input mode.)

## 9.1 Standard I/O characteristics

### Explanation on description

The input mode of the standard I/O characteristics is abbreviated as shown below.

0. Voltage input, -10 to 10V,  $20V \times 1/32,000$

①                      ②                      ③                      ④

- ① : Input mode set in BFM #0, BFM #1
- ② : Input mode
- ③ : Analog input range
- ④ : Resolution

- In the analog value direct display mode and the thermocouple input mode, ③ Analog input range and ④ Resolution are omitted.

**Figure 9.1: Standard I/O characteristics**

0. Voltage input, -10 to +10 V,  $20 V \times 1/32,000$

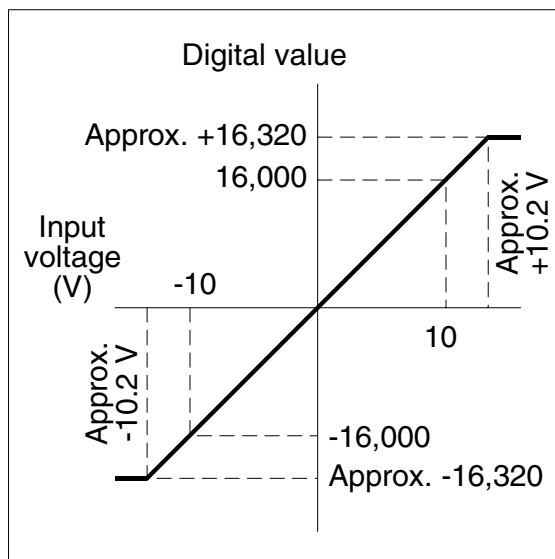

1. Voltage input, -10 to +10 V,  $20 V \times 1/8,000$

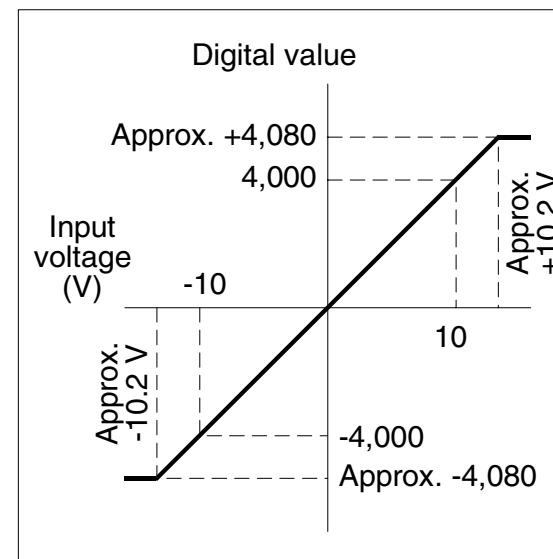



2. Voltage input, direct display (-10,000 to +10,000) 3. Current input, 4 to 20 mA, 16 mA x 1/8,000

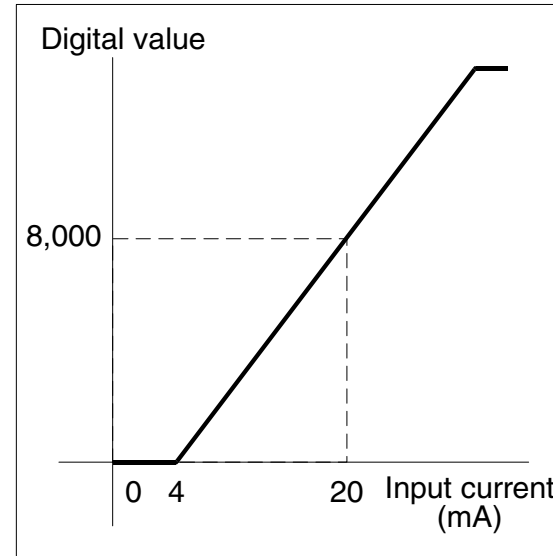
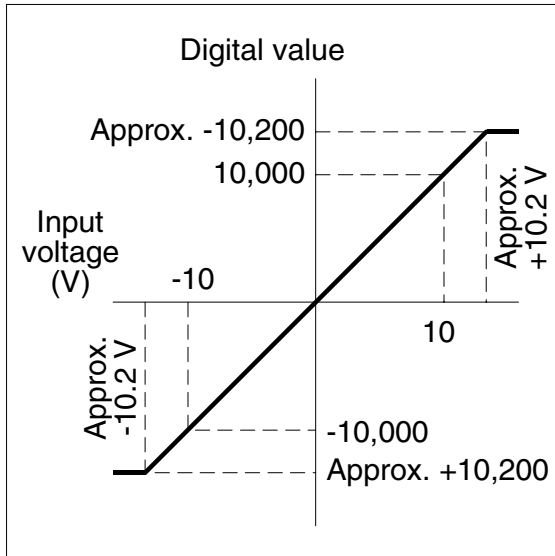

4. Current input, 4 to 20 mA, 16 mA x 1/4,000

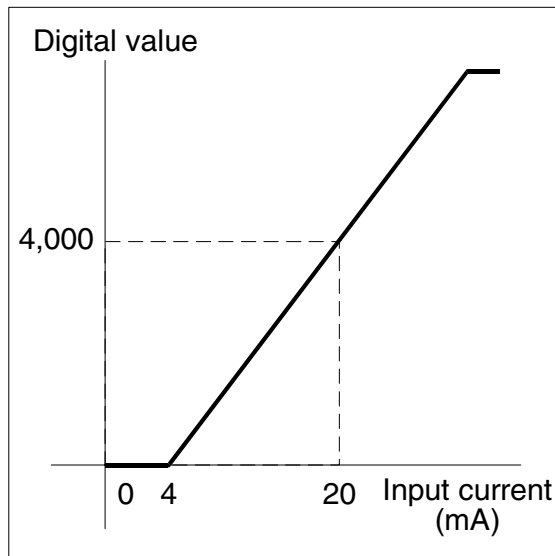

5. Current input, direct display (4,000 to 20,000)

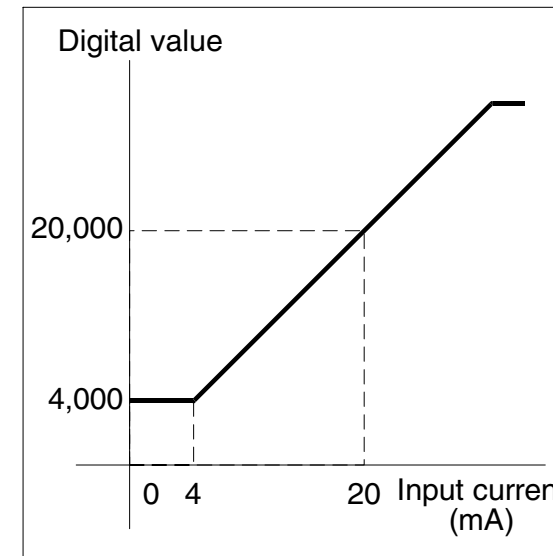

6. Current input, -20 to +20 mA, 40 mA x 1/16,000

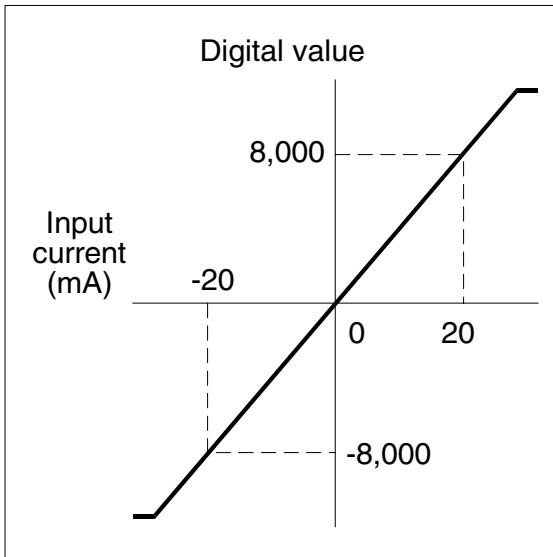

7. Current input, -20 to +20 mA, 40 mA x 1/8,000

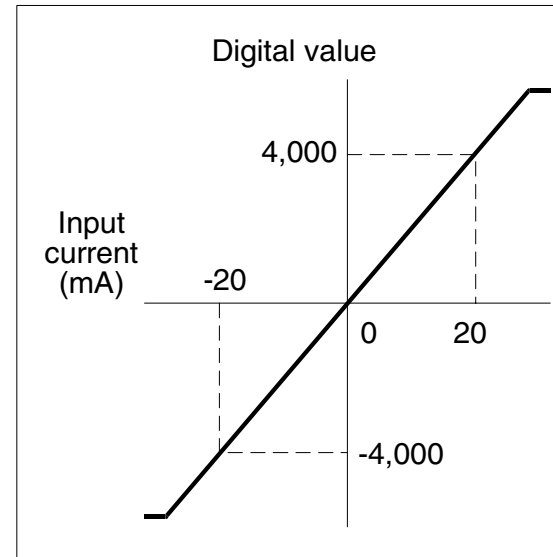

8. Current input, direct display (-20,000 to +20,000)

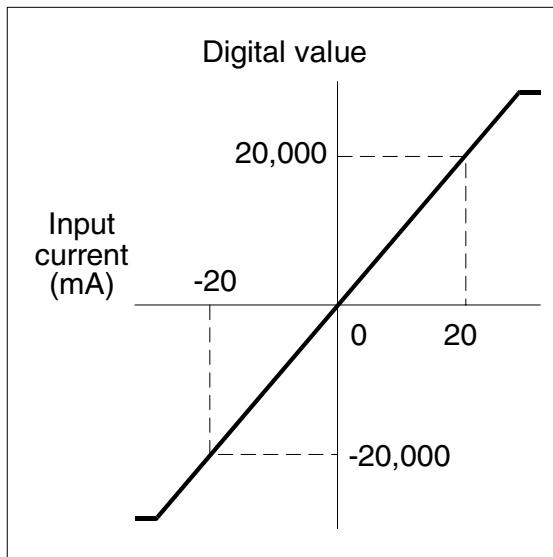

9. Thermocouple input, K type, Celsius

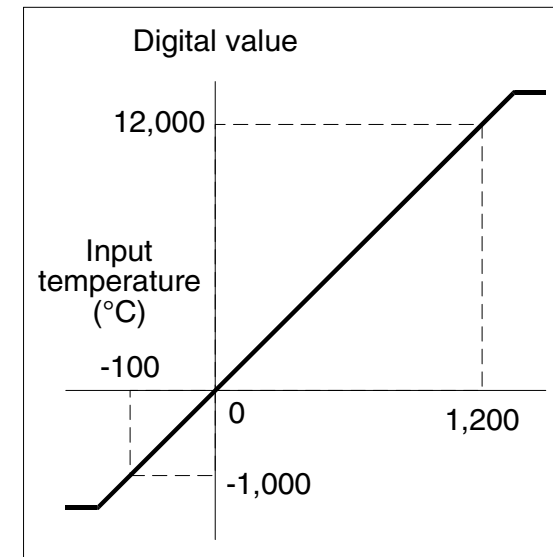

A. Thermocouple input, J type, Celsius

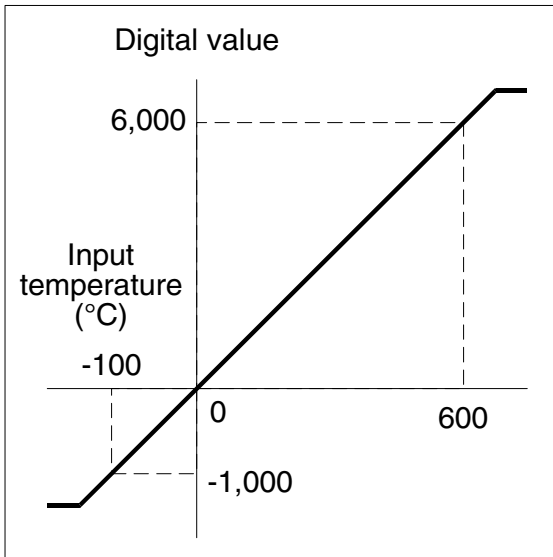

B. Thermocouple input, T type, Celsius

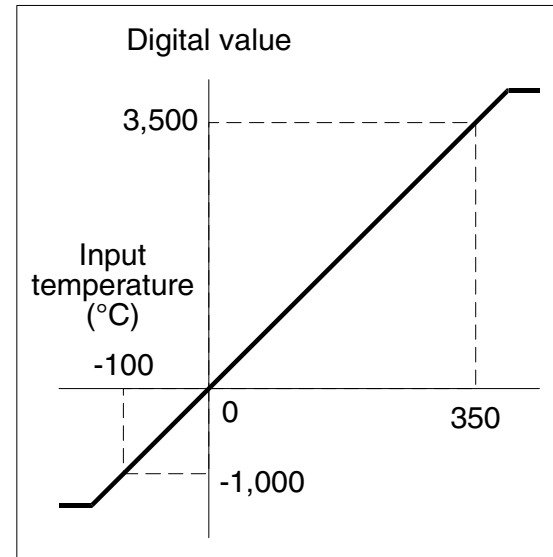

C. Thermocouple input, K type, Farenheit

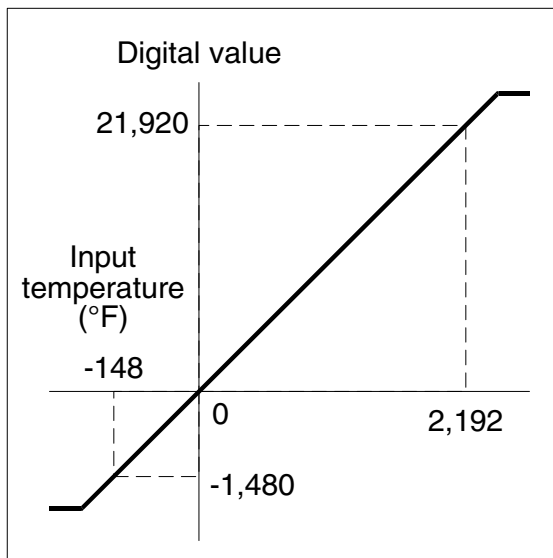

D. Thermocouple input, J type, Farenheit

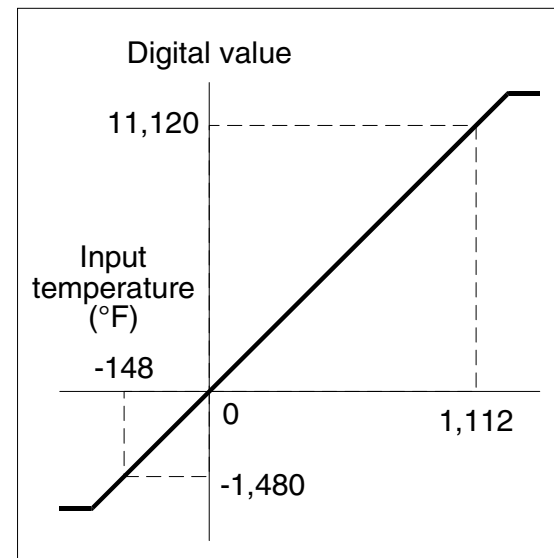

E. Thermocouple input, T type, Farenheit

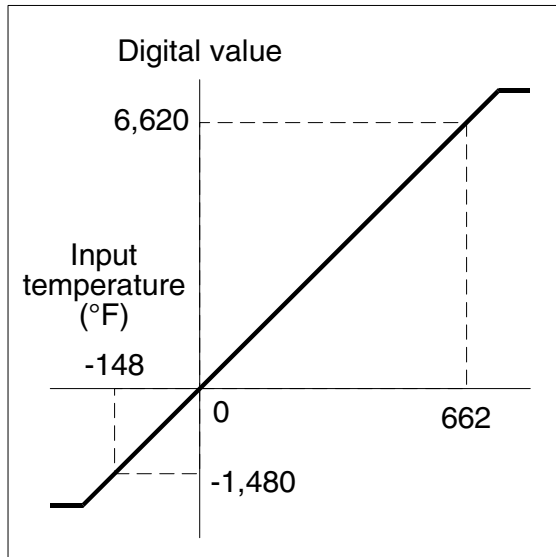

## 9.2 Adjustment of I/O characteristics

Adjust the I/O characteristics using the buffer memories in the FX<sub>2N</sub>-8AD.

At first, write the input mode to BFM #0 and BFM #1, write the offset data to BFM #41 to BFM #48, then write the gain data to BFM #51 to BFM #58. After that, update the offset data and the gain data of each channel using BFM #21.

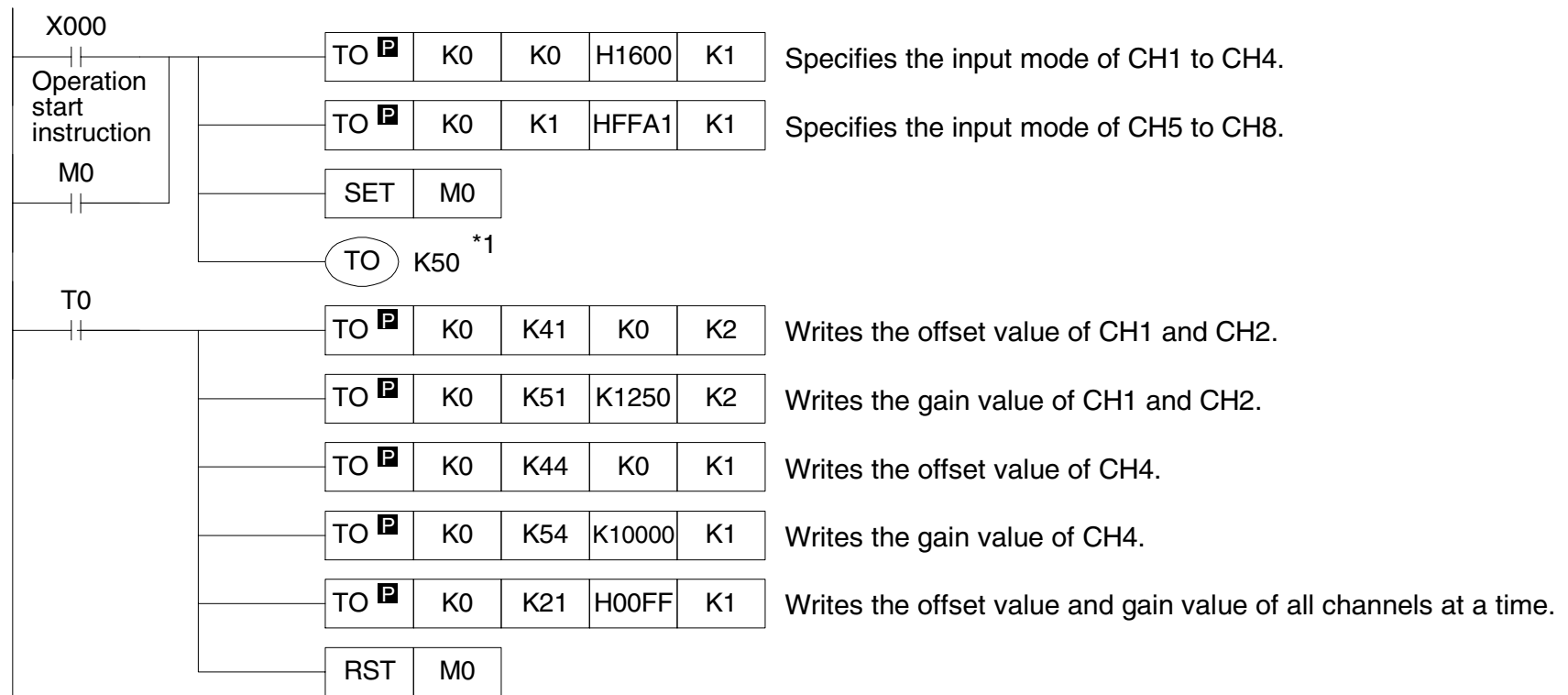
**Figure 9.2: Example program**

\*1 It takes approximately 5 seconds to change the input mode (BFM #0, BFM #1) (to change each set value).

Assure the time interval of 5 seconds or more after change of the input mode until execution of write of each setting (TO instruction).

- The I/O characteristics can be written (by BFM #21) to one channel at a time, or two or more channels at a time.

## 10. Example program

This section introduces an example of program to take analog data to the PLC using the FX<sub>2N</sub>-8AD.

### Condition

#### System configuration:

The FX<sub>2N</sub>-8AD (unit No. 0) is connected as a special block nearest to the FX<sub>2N</sub>/FX<sub>2NC</sub> Series PLC main unit.

#### Input mode:

CH1 and CH2 : Mode 0 (voltage input, -10 to +10 V, resolution 20 V x 1/32,000)

CH3 and CH4 : Mode 3 (current input, +4 to +20 mA, resolution 16 mA x 1/8,000)

CH5 and CH6 : Mode 9 (thermocouple input, K type, Celsius display)

CH7 and CH8 : Mode F (unused)

#### Number of times of averaging:

1 (initial value) in each channel

#### I/O characteristics:

Standard I/O characteristics (initial value) in each channel

#### Convenient function:

Upper/lower limit value detection function is used.

**Data history function:**

Used while sampling time is set to 0 ms (initial value).

CH1 to CH4 : Sampling time = 1 ms x 6 (Number of effective channels) = 6 ms

CH5 and CH6 : Sampling time = 40 ms x 6 (Number of effective channels) = 240 ms

**I/O assignment:**

X001 : Clears the upper/lower limit value error.

X002 : Clears the scale over error.

Y000 to Y017 : Output the upper/lower limit value error status of each channel.

Y020 to Y037 : Output scale over status of each channel.



Figure 10.1: Example program

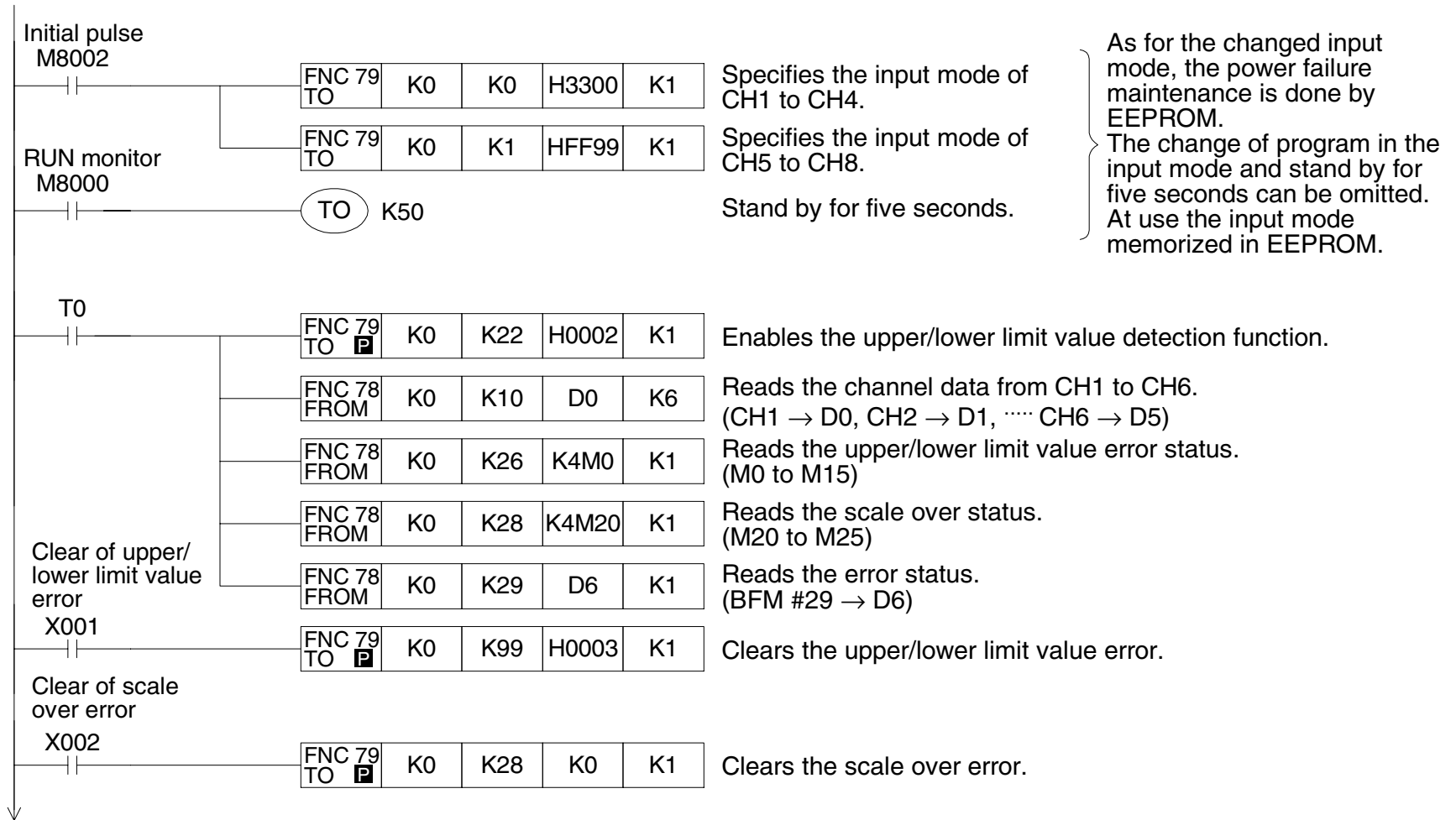

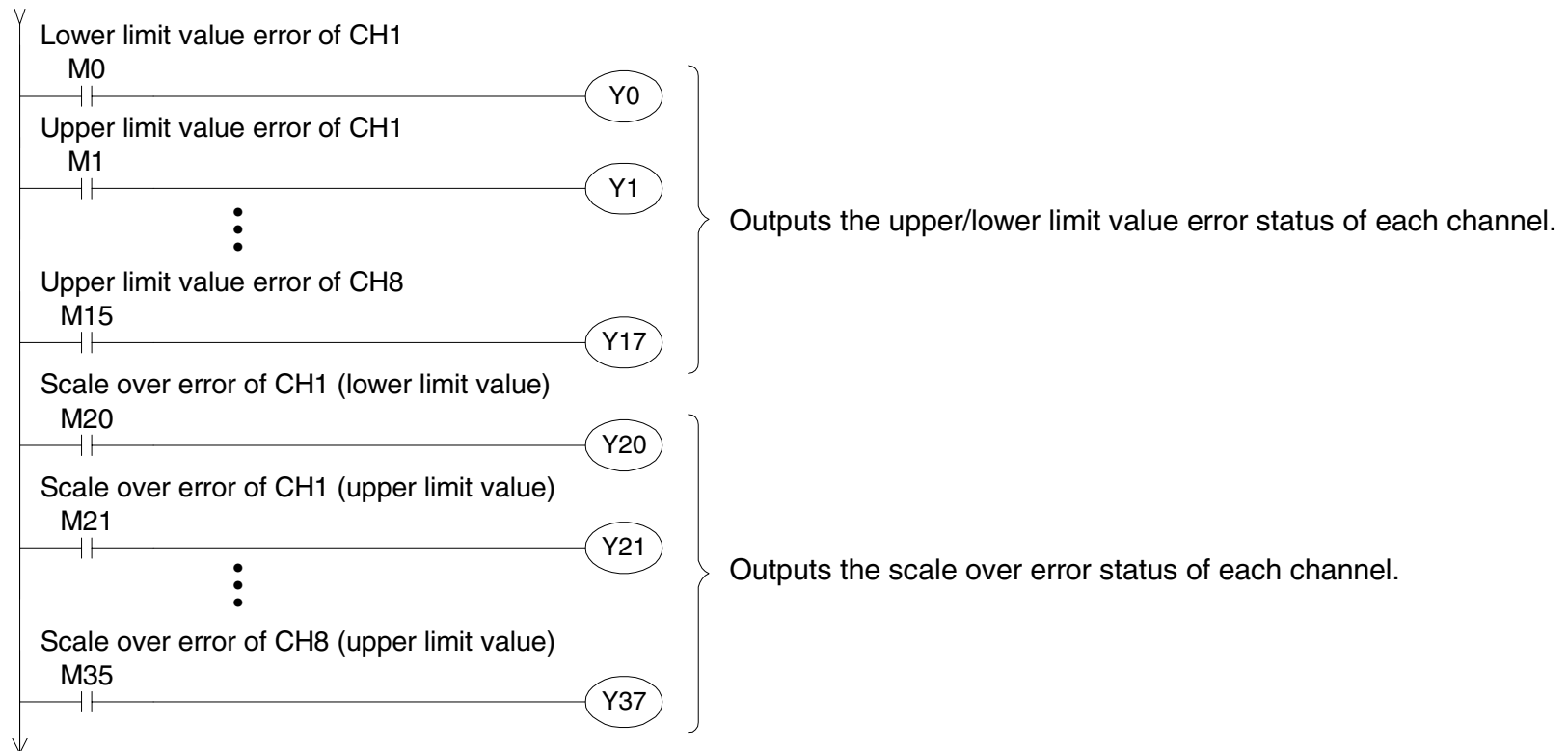

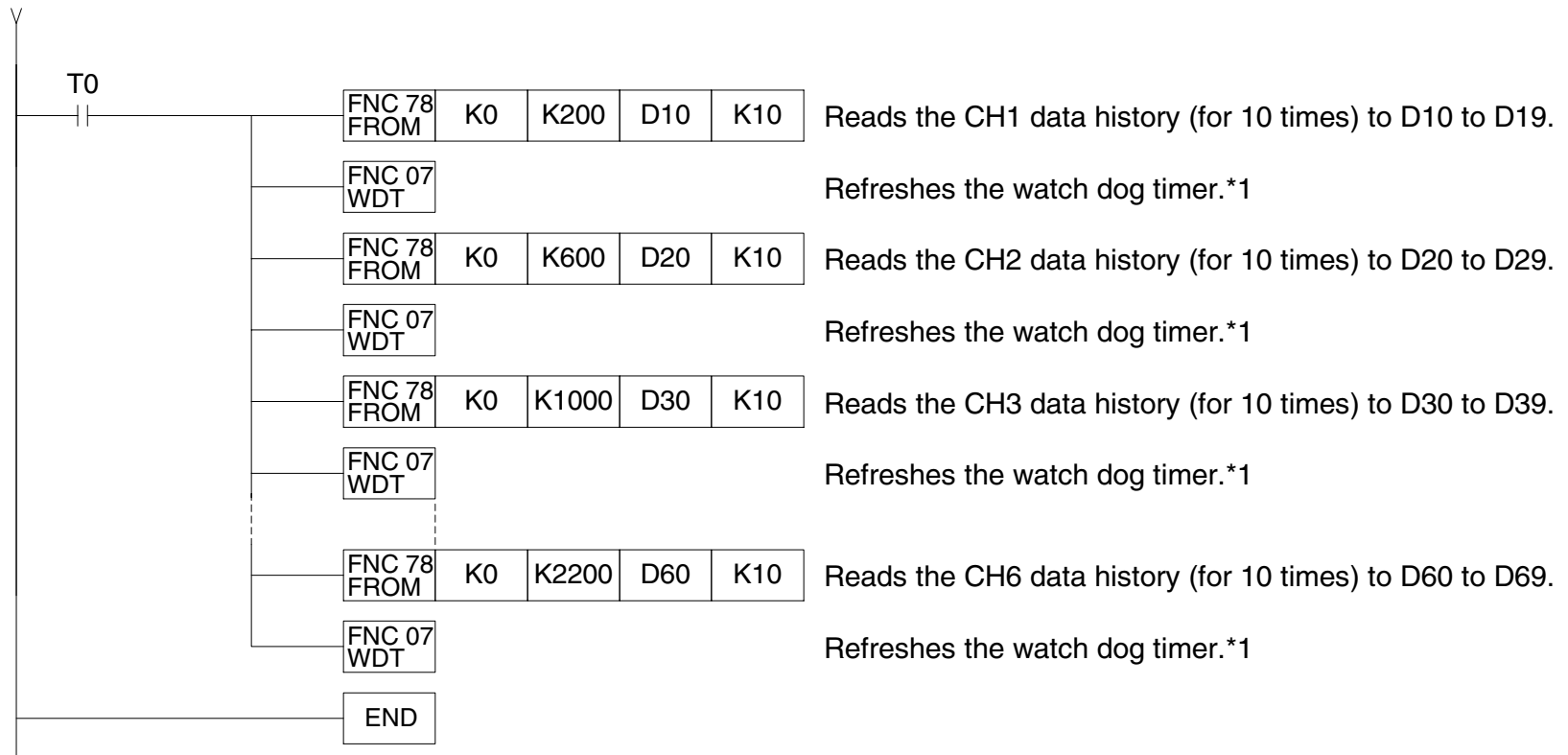

**Note:**

When many FROM/TO instructions are executed in the same scan, the PLC might have a watchdog timer error. In this case, add a watchdog timer reset (FNC07 WDT) instruction with each FROM/TO instruction.

# MEMO

## Appendix A: Associated Manuals List

For further information manual about FX Series, refer to following table.

**Table A-1: List of Further Information Manual**

Manual Name	Manual No.	Description
FX <sub>0</sub> /FX <sub>0N</sub> Hardware Manual	JY992D47501	This manual explains the wiring, installation and specifications for FX <sub>0</sub> and FX <sub>0N</sub> Series programmable controllers.
FX <sub>1N</sub> Hardware Manual	JY992D89301	This manual explains the wiring, installation and specifications for FX <sub>1N</sub> Series programmable controllers.
FX <sub>2N</sub> Hardware Manual	JY992D66301	This manual explains the wiring, installation and specifications for FX <sub>2N</sub> Series programmable controllers.
FX <sub>2NC</sub> Hardware Manual	JY992D76401	This manual explains the wiring, installation and specifications for FX <sub>2NC</sub> Series programmable controllers.
FX <sub>3U</sub> Series User's Manual - Hardware Edition	JY997D16501	This manual explains the wiring, installation and specification for FX <sub>3U</sub> Series programmable controllers.
FX <sub>3UC</sub> Series User's Manual - Hardware Edition	JY997D28701	This manual explains the wiring, installation and specification for FX <sub>3UC</sub> Series programmable controllers.

**Table A-1: List of Further Information Manual**

Manual Name	Manual No.	Description
FX Programming Manual	JY992D48301	This manual explains instructions for FX <sub>0</sub> , FX <sub>0S</sub> , FX <sub>0N</sub> , FX, FX <sub>2C</sub> , FX <sub>2N</sub> and FX <sub>2NC</sub> Series programmable controllers.
FX Programming Manual II	JY992D88101	This manual explains instructions for FX <sub>1S</sub> , FX <sub>1N</sub> , FX <sub>2N</sub> and FX <sub>2NC</sub> Series programmable controllers.
FX <sub>3U</sub> /FX <sub>3UC</sub> Series Programming Manual - Basic & Applied Instruction Edition	JY997D16601	This manual explains the instructions for FX <sub>3U</sub> /FX <sub>3UC</sub> Series programmable controller.



# USER'S MANUAL

FX<sub>2</sub>N-8AD Analog input block



HEAD OFFICE : TOKYO BUILDING, 2-7-3 MARUNOUCHI, CHIYODA-KU, TOKYO 100-8310, JAPAN  
HIMEJI WORKS : 840, CHIYODA CHO, HIMEJI, JAPAN

MODEL	FX <sub>2</sub> N-8AD-U-E
MODEL CODE	09R608

JY992D86001F  
(MEE)

Effective Sep. 2008  
Specifications are subject to change without notice.