

MELSEC FX Series

Programmable Logic Controllers

User's Manual
(Hardware)

FX2N-2LC Temperature Module

Foreword

- This manual contains text, diagrams and explanations which will guide the reader in the correct installation and operation of the communication facilities of FX series.
- Before attempting to install or use the communication facilities of FX series this manual should be read and understood.
- If in doubt at any stage of the installation of the communication facilities of FX series always consult a professional electrical engineer who is qualified and trained to the local and national standards which apply to the installation site.
- If in doubt about the operation or use of the communication facilities of FX series please consult the nearest Mitsubishi Electric distributor.
- This manual is subject to change without notice.

FX₂N-2LC

Temperature Control Block

USER'S MANUAL

Manual number : JY992D85801

Manual revision : D

Date : 3/2007

Guidelines for the Safety of the User and Protection of the Temperature control block FX_{2N}-2LC.

This manual provides information for the use of the Temperature control block FX_{2N}-2LC. The manual has been written to be used by trained and competent personnel. The definition of such a person or persons is as follows;

- a) Any engineer who is responsible for the planning, design and construction of automatic equipment using the product associated with this manual should be of a competent nature, trained and qualified to the local and national standards required to fulfill that role. These engineers should be fully aware of all aspects of safety with regards to automated equipment.
- b) Any commissioning or service engineer must be of a competent nature, trained and qualified to the local and national standards required to fulfill that job. These engineers should also be trained in the use and maintenance of the completed product. This includes being completely familiar with all associated documentation for the said product. All maintenance should be carried out in accordance with established safety practices.
- c) All operators of the completed equipment (see Note) should be trained to use this product in a safe manner in compliance to established safety practices. The operators should also be familiar with documentation which is associated with the operation of the completed equipment.

Note : Note: the term 'completed equipment' refers to a third party constructed device which contains or uses the product associated with this manual.

Notes on the Symbols Used in this Manual

At various times throughout this manual certain symbols will be used to highlight points of information which are intended to ensure the users personal safety and protect the integrity of equipment. Whenever any of the following symbols are encountered its associated note must be read and understood. Each of the symbols used will now be listed with a brief description of its meaning.

Hardware Warnings



- 1) Indicates that the identified danger **WILL** cause physical and property damage.



- 2) Indicates that the identified danger could **POSSIBLY** cause physical and property damage.



- 3) Indicates a point of further interest or further explanation.

Software Warnings



- 4) Indicates special care must be taken when using this element of software.



- 5) Indicates a special point which the user of the associate software element should be aware of.



- 6) Indicates a point of interest or further explanation.

- Under no circumstances will Mitsubishi Electric be liable responsible for any consequential damage that may arise as a result of the installation or use of this equipment.
- All examples and diagrams shown in this manual are intended only as an aid to understanding the text, not to guarantee operation. Mitsubishi Electric will accept no responsibility for actual use of the product based on these illustrative examples.
- Please contact a Mitsubishi Electric distributor for more information concerning applications in life critical situations or high reliability.

Guidelines	V
1. Introduction	1-1
1.1 Outline of product	1-2
2. Product Configuration	2-1
2.1 Outside dimension	2-1
2.2 Name of each part	2-1
2.3 Status indication	2-2
2.4 Installation method	2-3
2.5 Connection to PLC Main Unit	2-4
3. Specifications	3-1
3.1 General specifications	3-1
3.2 Power supply specifications	3-1
3.3 Performance specifications	3-2
3.4 Input specifications	3-3
3.5 Input range	3-4
3.6 Output specifications	3-5
4. Wiring	4-1
4.1 Wiring	4-2
4.2 Crimp terminal	4-3
5. Introduction of Functions	5-1
5.1 PID control	5-1
5.1.1 Easy PID control with two degrees of freedom	5-1
5.1.2 Overshoot prevention function	5-2
5.2 Two-position control	5-3
5.3 Auto tuning function	5-4
5.3.1 AT (auto tuning)	5-4
5.3.2 Conditions for performing and aborting AT	5-5
5.3.3 AT bias	5-6
5.4 Auto / manual	5-7
5.4.1 Auto mode and manual mode	5-7
5.4.2 Balance-less, bump-less function	5-7
5.5 Heater disconnection alarm function	5-8
5.6 Loop breaking alarm function (LBA)	5-9
6. Alarm	6-1

7. Buffer Memory (BFM)	7-1
7.1 Buffer memory list.....	7-1
7.2 Details of buffer memories.....	7-4
7.2.1 BFM #0: Flag.....	7-4
7.2.2 BFM #1 (CH1) and BFM #2 (CH2): Event.....	7-5
7.2.3 BFM #3 (CH1) and BFM #4 (CH2): Measured value (PV)	7-7
7.2.4 BFM #5 (CH1) and BFM #6 (CH2): Control output value (MV)	7-7
7.2.5 BFM #7 (CH1) and BFM #8 (CH2): Heater current measured value.....	7-7
7.2.6 BFM #9: Initialization command	7-7
7.2.7 BFM #10: Error reset command	7-7
7.2.8 BFM #11: Control start/stop changeover.....	7-7
7.2.9 BFM #12 (CH1) and BFM #21 (CH2) : Set value (SV)	7-8
7.2.10 BFM #13 to BFM #16 (CH1) and BFM #22 to BFM #25 (CH2): Alarm 1/2/3/4 set value	7-8
7.2.11 BFM #17 (CH1) and BFM #26 (CH2): Heater disconnection alarm set value	7-8
7.2.12 BFM #18 (CH1) and BFM #27 (CH2) : Auto/manual mode changeover	7-8
7.2.13 BFM #19 (CH1) and BFM #28 (CH2): Manual output set value	7-9
7.2.14 BFM #20 (CH1) and BFM #29 (CH2): Auto tuning execution command.....	7-9
7.2.15 BCM#30: Unit type code.....	7-9
7.2.16 BFM #32 (CH1) and BFM #51 (CH2): Operation mode	7-9
7.2.17 BFM #33 (CH1) and BFM #52 (CH2): Proportional band (P)	7-9
7.2.18 BFM #34 (CH1) and BFM #53 (CH2): Integral time (I)	7-10
7.2.19 BFM #35 (CH1) and BFM #54 (CH2): Derivative time (D)	7-10
7.2.20 BFM #36 (CH1) and BFM #55 (CH2): Control response parameter	7-11
7.2.21 BFM #37 (CH1) and BFM #56 (CH2): Output limiter upper limit BFM #38 (CH1) and BFM #57 (CH2): Output limiter lower limit.....	7-12
7.2.22 BFM #39 (CH1) and BFM #58 (CH2): Output change ratio limiter.....	7-13
7.2.23 BFM #40 (CH1) and BFM #59 (CH2): Sensor correction value setting (PV bias)...	7-14
7.2.24 BFM #41 (CH1) and BFM #60 (CH2): Adjustment sensitivity (dead zone) setting..	7-15
7.2.25 BFM #42 (CH1) and BFM #61 (CH2): Control output cycle setting.....	7-15
7.2.26 BFM #43 (CH1) and BFM #62 (CH2): Primary delay digital filter setting	7-16
7.2.27 BFM #44 (CH1) and BFM #63 (CH2): Setting change ratio limiter.....	7-17
7.2.28 BFM #45 (CH1) and BFM #64 (CH2): AT (auto tuning) bias.....	7-18
7.2.29 BFM #46 (CH1) and BFM #65 (CH2): Normal/reverse operation selection	7-18
7.2.30 BFM #47 (CH1) and BFM #66 (CH2): Setting the upper limit BFM #48 (CH1) and BFM #67 (CH2): Setting the lower limit.....	7-19
7.2.31 BFM #49 (CH1) and BFM #68 (CH2): Loop breaking alarm judgement time.....	7-20
7.2.32 In BFM #50, set the loop breaking alarm dead zone of CH1. In BFM #69, set the loop breaking alarm dead zone of CH2.....	7-21
7.2.33 BFM #70 (CH1) and BFM #71 (CH2): Input type selection	7-22
7.2.34 BFM #72 to BFM #75: Alarm mode setting	7-23
7.2.35 BFM #76: Alarm 1/2/3/4 dead zone setting	7-25
7.2.36 BFM #77: Number of times of alarm 1/2/3/4 delay	7-26
7.2.37 BFM #78: Number of times of heater disconnection alarm delay.....	7-26
7.2.38 BFM #79: Temperature rise completion range setting	7-26
7.2.39 BFM #80: Temperature rise completion soak time.....	7-27
7.2.40 BFM #81: CT monitor method changeover	7-27
7.2.41 BFM #82: Set value range error address	7-27
7.2.42 BFM #83: Set value backup command.....	7-28
8. Program Example	8-1
8.1 Program example	8-2
9. Diagnostic	9-1

1	Introduction
2	Product Configuration
3	Specifications
4	Wiring
5	Introduction of Functions
6	Alarm
7	Buffer Memory (BFM)
8	Program Example
9	Diagnostic

1. Introduction



Cautions on design

- Install a safety circuit outside the PLC or the temperature control block FX_{2N}-2LC so that the entire system conservatively operates even if an abnormality occurs in the external power supply or a failure occurs in the PLC or the FX_{2N}-2LC.
If a safety circuit is installed inside the PLC, malfunction and erroneous output may cause accidents.
- 1) Make sure to construct an emergency stop circuit, protection circuit or interlock circuit to prevent damages of a machine, etc. outside the PLC or the FX_{2N}-2LC.
 - 2) If the PLC or the FX_{2N}-2LC detects an abnormality such as a watch dog timer error or input value error by the self-diagnosis function or when an abnormality occurs in the I/O control area, etc. which cannot be detected by the CPU in the PLC, output control may be disabled.
Design external circuits and structure so that the entire system conservatively operates in such cases.
 - 3) If a failure occurs in a relay, transistor, TRIAC, etc. in an output unit of the FX_{2N}-2LC or the PLC, outputs may keep ON or OFF.
For output signals which may lead to severe accidents, design external circuits and structure so that the entire system conservatively operates.



Cautions on installation

- Use the unit in the environment for the general specifications described in the manual. Never use the unit in a place with dusts, soot, conductive dusts, corrosive gas or flammable gas, place exposed to high temperature, dew condensation or rain and wind or place exposed to vibration or impact.
If the unit is used in such a place, electrical shock, fire, malfunction, damages in the unit or deterioration of the unit may be caused.
- Never drop cutting chips or electric wire chips into the ventilation window of the FX_{2N}-2LC while drilling screw holes or wiring cables.
Such chips may cause fire, failure or malfunction.
- After finishing installation, remove a dust preventing sheet adhered on the ventilation window of the PLC and the FX_{2N}-2LC.
If the sheet remains attached, fire, failure or malfunction may be caused.
- Securely connect cables such as extension cables and memory cassettes to specified connectors.
Imperfect contact may cause malfunction.



Caution on disposal

- When disposing of the unit, treat it as industrial waste.

1.1 Outline of product

The temperature control block FX_{2N}-2LC (hereafter referred to as "temperature control block" or "FX_{2N}-2LC") equipped with two temperature input points and two transistor (open collector) output points is a special block to read temperature signals from thermocouples and platinum resistance thermometer bulbs, and perform PID output control.

Connect the FX_{2N}-2LC to the FX_{1N}/FX_{2N}/FX_{2NC}/FX_{3U} Series PLC.

- 1) As input sensors, two thermocouples, two platinum resistance thermometer bulbs or one thermocouple and one platinum resistance thermometer bulb are available.
- 2) Data can be written and read using FROM/TO instructions when the FX_{2N}-2LC is connected to the FX_{1N}/FX_{2N}/FX_{2NC}/FX_{3U} Series PLC.
(The FX_{2N}-2LC performs arithmetic operation for PID control and output control. You do not have to create sequence programs for PID operation.)
- 3) Disconnection of heaters can be detected by current detection (CT).
- 4) The proportional band, the integral time and the derivative time can be easily set by auto tuning.
- 5) Channels are isolated against each other.

1	Introduction
2	Product Configuration
3	Specifications
4	Wiring
5	Introduction of Functions
6	Alarm
7	Buffer Memory (BFM)
8	Program Example
9	Diagnostic

2. Product Configuration

2.1 Outside dimension

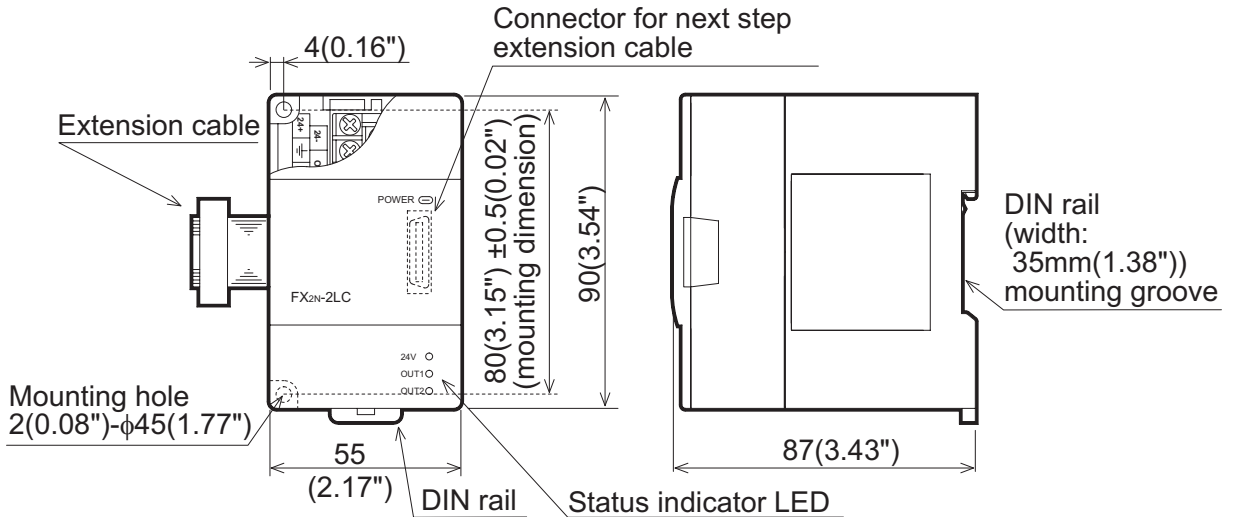

Unit: mm (inches)

Mass: 0.3kg (0.66lbs)

Outer color: Munsell 0.08GY / 7.64 / 0.81

2.2 Name of each part

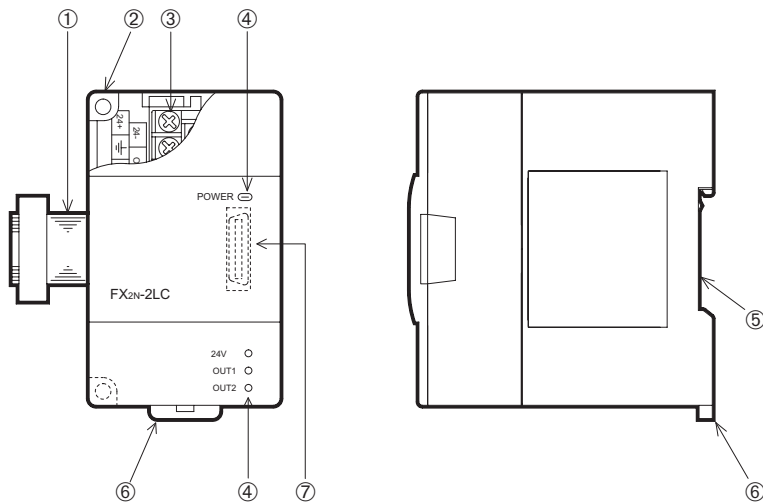

Terminal block

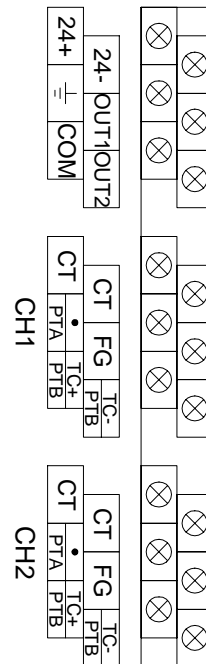

- ① :PLC connection cable
- ② :Screw mounting hole
- ③ :24V DC/Input/Output terminal (M3 terminal screws)
- ④ :Status indicator LED
- ⑤ :DIN rail mounting groove (DIN rail width: 35mm(1.38"))
- ⑥ :DIN rail mounting hook
- ⑦ :Connector for next step extension cable

2.3 Status indication

Table 2.1:

LED name	Indication	Description
POWER	Lit (green)	5 V power is supplied from PLC main unit.
	Extinguished	5 V power is not supplied from PLC main unit.
24V	Lit (red)	24 V power is supplied from outside.
	Extinguished	24 V power is not supplied from outside.
OUT1	Lit (red)	OUT1 output is ON.
	Extinguished	OUT1 output is OFF.
OUT2	Lit (red)	OUT2 output is ON.
	Extinguished	OUT2 output is OFF.

2.4 Installation method

The FX2N-2LC can be installed on the right side of an FX1N/FX2N/FX2NC/FX3U Series PLC main unit, FX1N/FX2N/FX2NC/FX3U Series extension unit or another extension block.

The FX2N-2LC can be attached with a DIN rail DIN46277 (width: 35 mm) or directly attached to a panel surface with screws (M4).

- Installation on DIN rail
Align the upper side of the DIN rail mounting groove of the FX2N-2LC with a DIN rail DIN46277 (width: 35 mm) (①), and push the FX2N-2LC on the DIN rail (②).
When removing the FX2N-2LC, pull out downward the DIN rail mounting hook (③), then remove the FX2N-2LC (④).

When attaching to DIN rail

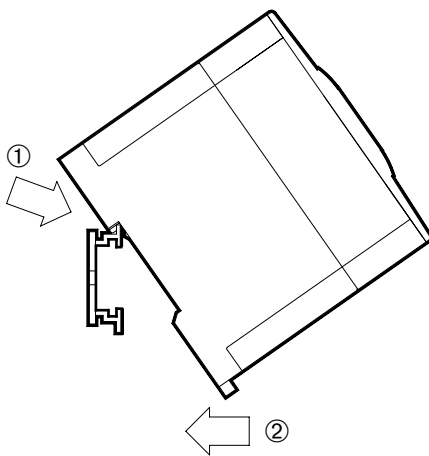

When removing from DIN rail

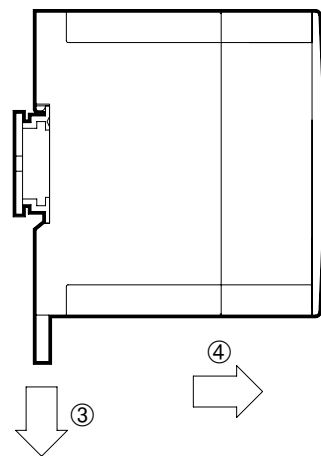

- Direct installation on panel surface
Screw-tighten the FX2N-2LC with M4 screws to a panel surface using two (upper and lower) mounting holes provided on the left side of the FX2N-2LC.
Assure the interval of 1 to 2 mm between a unit or block installed on the left side of the FX2N-2LC.



Cautions on installation

- Use the unit in the environment for the general specifications described in the manual. Never use the unit in a place with dusts, soot, conductive dusts, corrosive gas or flammable gas, place exposed to high temperature, dew condensation or rain and wind or place exposed to vibration or impact.
If the unit is used in such a place, electrical shock, fire, malfunction, damages in the unit or deterioration of the unit may be caused.
- Never drop cutting chips or electric wire chips into the ventilation window of the FX2N-2LC while drilling screw holes or wiring cables.
Such chips may cause fire, failure or malfunction.
- After finishing installation, remove a dust preventing sheet adhered on the ventilation window of the PLC and the FX2N-2LC.
If the sheet remains attached, fire, failure or malfunction may be caused.
- Securely connect cables such as extension cables and memory cassettes to specified connectors.
Imperfect contact may cause malfunction.

2.5 Connection to PLC Main Unit

Connect the FX2N-2LC to the PLC main unit with an extension cable.

FX2N-2LC units are treated as special blocks of the PLC, and the special block No. 0 to 7 is automatically assigned to each FX2N-2LC unit from the one nearest to the PLC main unit. (These unit Nos. are used in FROM/TO instructions.)

One FX2N-2LC unit occupies eight I/O points in the PLC main unit.

For the details of I/O assignment in the PLC, refer to the respective FX1N/FX2N/FX2NC/FX3U Series PLC manual.

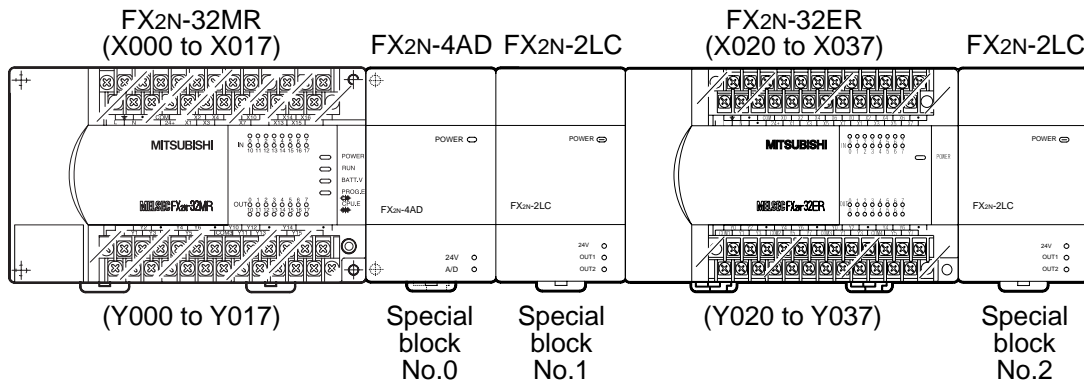

() indicates the I/O No. assignment in the PLC main unit.

- Up to eight FX2N-2LC units can be connected to the FX1N/FX2N/FX3U Series PLC. Up to four FX2N-2LC units can be connected to the FX2NC Series PLC.
- When connecting the FX2N-2LC unit to the FX2NC Series PLC, the interface FX2NC-CNV-IF is required.
- For extension, an extension cable FX0N-65EC (650 mm) and the FX2N-CNV-BC sold separately are required. Only one FX0N-65EC can be used per system.

1	Introduction
2	Product Configuration
3	Specifications
4	Wiring
5	Introduction of Functions
6	Alarm
7	Buffer Memory (BFM)
8	Program Example
9	Diagnostic

3. Specifications

3.1 General specifications

Table 3.1:

Item	Specifications
Withstand voltage	500 VAC for 1 minute (between analog input terminal and grounding terminal)

Other general specifications are equivalent to those for the PLC main unit. (Refer to the manual of the PLC main unit.)

3.2 Power supply specifications

Table 3.2:

Item	Specifications
Driving power supply	24 VDC (-15% to +10%), input from driving power supply terminal
Power supply for communication	5 VDC (supplied from inside of PLC main unit)
Current consumption	24 VDC, 55 mA and 5 VDC, 70 mA
Insulation method	Analog input area and PLC are insulated by photocoupler. Power supply and analog input are insulated by DC/DC converter. (Channels are insulated each other.)
Number of occupied I/O points	8 points in total (including input points and output points)

3.3 Performance specifications

Table 3.3:

Item		Description	
Control method		Two-position control, PID control (with auto tuning function), PI control	
Control operation period		500 ms	
Set temperature range		Equivalent to input range (Refer to 7.2.33)	
Heater disconnection detection		Alarm is detected in accordance with setting of buffer memory. (Variable within range from 0.0 to 100.0 A.).	
Operation mode		0: Measured value monitor 1: Measured value monitor + Temperature alarm 2: Measured value monitor + Temperature alarm + Control (Selected by buffer memory)	
Self-diagnosis function		Adjustment data and input value are checked by watch dog timer. When abnormality is detected, transistor output turns OFF.	
Memory		Built-in EEPROM (Number of times of overwrite: 100,000 times)	
Status indication	POWER	Lit (green)	5 V power is supplied from PLC main unit.
		Extinguished	5 V power is not supplied from PLC main unit.
	24V	Lit (red)	24 V power is supplied from outside.
		Extinguished	24 V power is not supplied from outside.
	OUT1	Lit (red)	OUT1 output is ON.
		Extinguished	OUT1 output is OFF.
	OUT2	Lit (red)	OUT2 output is ON.
		Extinguished	OUT2 output is OFF.

3.4 Input specifications

Table 3.4:

Item		Description	
Temperature input	Number of input points	2 points	
	Input type	Thermocouple	K, J, R, S, E, T, B, N, PLII, WRe5=26, U, L JIS C 1602-1995
		Resistance thermometer bulb	3-wire Pt100 JIS C 1604-1997, JPt100 JIS C 1604-1981
	Measurement precision	± 0.7 % of range span ± 1 digit (± 0.3 % of range span ± 1 digit when ambient temperature is 23 °C ± 5 °C) However, 0 to 399 °C (0 to 799 °F) in B inputs as well as 0 to 32 °F in PLII and WRe5-26 inputs are outside precision guarantee range.	
	Cold contact temperature compensation error	Within ± 1.0 °C However, within ± 2.0 °C while input value is -150 to -100 °C within ± 3.0 °C while input value is -200 to -150 °C	
	Resolution	0.1 °C (0.1 °F) or 1 °C (1 °F) (Varies depending on input range of used sensors.)	
	Sampling period	500 mS	
	Effect of external resistance	Approx. 0.35 μV/Ω	
	Input impedance	1 M Ω or more	
	Sensor current	Approx. 0.3 mA	
	Allowable input lead wire resistance	10 Ω or less	
	Operation when input is disconnected	Upscale	
	Operation when input is short-circuited	Downscale	
	CT input	Number of input points	2 points
Current detector		CTL-12-S36-8 or CTL-6-P-H (manufactured by U.R.D. Co., Ltd.)	
Heater current measured value		When CTL-12 is used	0.0 to 100.0 A
		When CTL-6 is used	0.0 to 30.0 A
Measurement precision		Larger one between ± 5 % of input value and 2 A (excluding precision of current detector)	
Sampling period		1 second	

3.5 Input range

Table 3.5:

Sensor type	K	J	R	S
Input range	-200.0 to 200.0 °C -100.0 to 400.0 °C -100 to 1300 °C -100 to 800 °F -100 to 2400 °F	-200.0 to 200.0 °C -100.0 to 400.0 °C -100.0 to 800.0 °C -100 to 1200 °C -100 to 1600 °F -100 to 2100 °F	0 to 1700 °C 0 to 3200 °F	0 to 1700 °C 0 to 3200 °F

Sensor type	E	T	B	N
Input range	-200.0 to 200.0 °C 0 to 1000 °C 0 to 1800 °F	-200.0 to 200.0 °C -200.0 to 400.0 °C 0.0 to 400.0 °C -300.0 to 400.0 °F -300.0 to 700.0 °F 0.0 to 700.0 °F	0 to 1800 °C 0 to 3000 °F	0 to 1300 °C 0 to 2300 °F

Sensor type	PL II	WRe5-26	U	L
Input range	0 to 1200 °C 0 to 2300 °F	0 to 2300 °C 0 to 3000 °F	-200.0 to 600.0 °C -300.0 to 700.0 °F	0.0 to 900.0 °C 0 to 1600 °F

Sensor type	JPt100	Pt100
Input range	-50.0 to 150.0 °C -200.0 to 500.0 °C -300.0 to 300.0 °F -300 to 900 °F	-50.0 to 150.0 °C -200.0 to 600.0 °C -300.0 to 300.0 °F -300 to 1100 °F

- When B is used, 0 to 399 °C (0 to 799 °F) is outside the precision compensation range.
- When PLII is used, 0 to 32 °F is outside the precision compensation range.
- When WRe5-26 is used, 0 to 32 °F is outside the precision compensation range.

3.6 Output specifications

Table 3.6:

Item	Description
Number of output points	2 points
Output method	NPN open collector transistor output
Rated load voltage	5 to 24 VDC
Maximum load voltage	30 VDC or less
Maximum load current	100 mA
Leak current in OFF status	0.1 mA or less
Maximum voltage drop in ON status	2.5 V (maximum) or 1.0 V (typical) at 100 mA
Control output cycle	30 seconds (Variable within range from 1 to 100 seconds)

MEMO

1	Introduction
2	Product Configuration
3	Specifications
4	Wiring
5	Introduction of Functions
6	Alarm
7	Buffer Memory (BFM)
8	Program Example
9	Diagnostic

4. Wiring



Cautions on Wiring

- Make sure to shut down the power supplies of all phases on the outside before starting installation or wiring.
If the power supplies are not shut down, you may get electrical shock or the unit may be damaged.
- As to loads which are dangerous when turning ON at the same time, make sure to interlock them outside the PLC and the FX_{2N}-2LC in addition to interlocking of them in a program in the PLC.



- Connect the power cable of the FX_{2N}-2LC temperature control block and the PLC as explained in the contents of this manual.
The product maybe seriously damaged if an AC power supply is connected to the DC I/O terminal or DC power terminal.
- Never perform external wiring to unused terminals  in the FX_{2N}-2LC and the PLC.
Such wiring may damage the units.
- Perform Class 3 grounding with an electric wire of 2 mm² or more to the grounding terminal in the FX_{2N}-2LC and the PLC.
However, never perform common grounding with a strong power system.

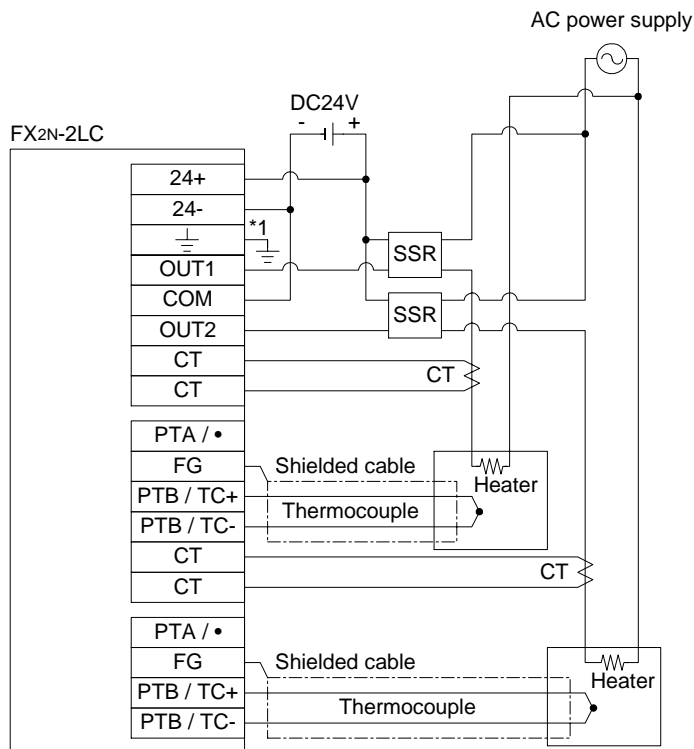

4.1 Wiring

When a temperature sensor is a thermocouple (TC)

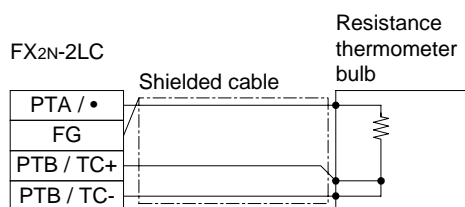

When a temperature sensor is a resistance thermometer bulb (RTD)



*1 Connect the  terminal in the FX2N-2LC to the  terminal in the PLC to which Class 3 grounding is performed.

- When using a thermocouple, use specified compensating lead wires.
- When using a resistance thermometer bulb, use the three-wire type, and perform wiring with lead wires having small resistance and no difference in the resistance among the three wires.
- Terminal tightening torque: 0.5 to 0.8 N·m

4.2 Crimp terminal

When connecting one wire to a terminal screw, use a crimp terminal of the following dimension and crimp it as shown in the diagram.

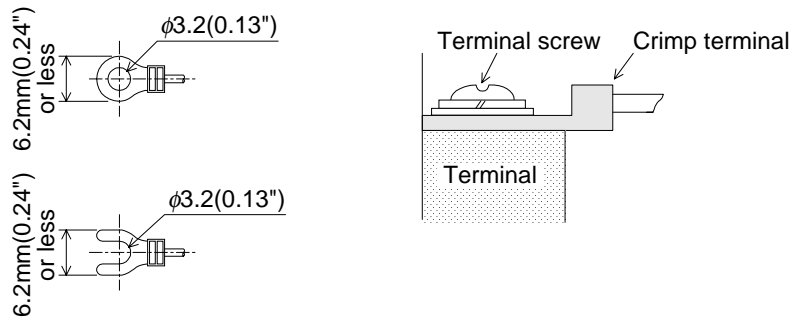

When connecting two wires to a terminal screw, use crimp terminals of the following dimension and crimp them as shown in the diagram.

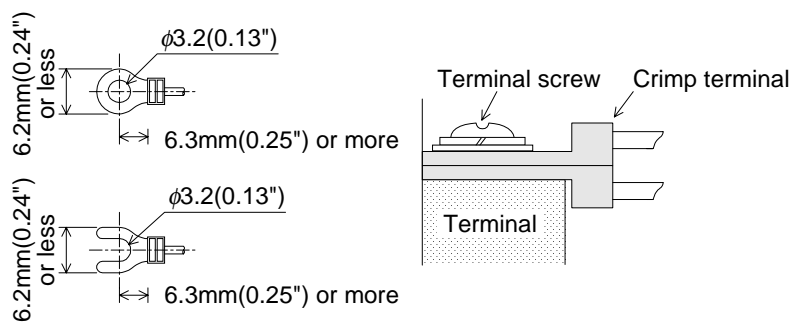

MEMO

1	Introduction
2	Product Configuration
3	Specifications
4	Wiring
5	Introduction of Functions
6	Alarm
7	Buffer Memory (BFM)
8	Program Example
9	Diagnostic

5. Introduction of Functions

This section introduces the functions of the FX_{2N}-2LC.
 For setting of each function, refer to the description on buffer memories (BFM) later.

5.1 PID control

5.1.1 Easy PID control with two degrees of freedom

PID control is a control method to obtain stable control result by setting each of the constants "P (proportional band)", "I (integral time)" and "D (derivative time)".

However, if each PID constant is so set that the "response to setting" becomes good, the "response to disturbance" becomes deteriorated in PID control. On the contrary, if each PID constant is so set that the "response to disturbance" becomes good, the "response to setting" becomes deteriorated.

The FX_{2N}-2LC performs easy PID control with two degrees of freedom in which PID constants realizing good response to disturbance are adopted and the shape of the "response to setting" can be selected as either "fast", "medium" or "slow".

Setting of PID constants and selection of the "response to setting" can be performed using buffer memories.

5

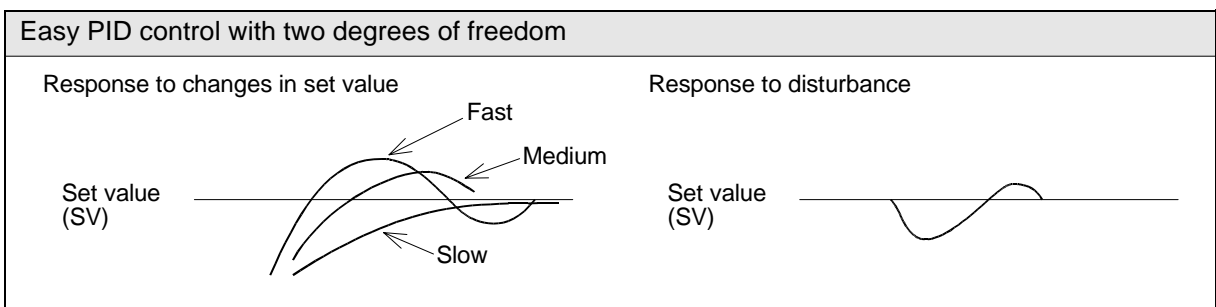
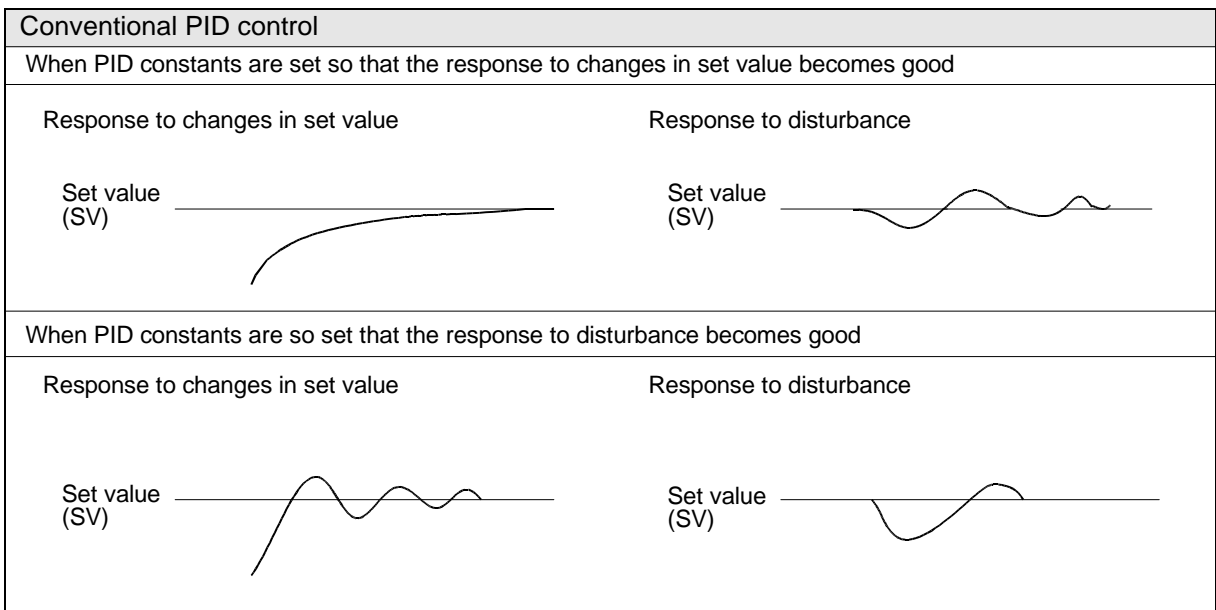

5.1.2 Overshoot prevention function

Generally in PID control, when a deviation continues for a long time, the PID arithmetic operation result exceeds the effective range (from 0 to 100%) of the operation quantity. At this time, even if the deviation becomes smaller, it takes some time until the output comes within the effective range because of the integral operation. As a result, execution of an actual correction operation is delayed, and overshoot/undershoot occurs.

In order to prevent overshoot, the FX₂N-2LC is equipped with the RFB (reset-feedback) limiter function. The RFB limiter function feeds back the excessive quantity to the integral value and makes the arithmetic operation result be held at the limit point when the PID arithmetic operation result exceeds the limit point (upper/lower limit of the output limiter) so that the PID arithmetic operation result always remains inside the effective range. Accordingly, when a deviation becomes small, the correction operation is immediately performed.

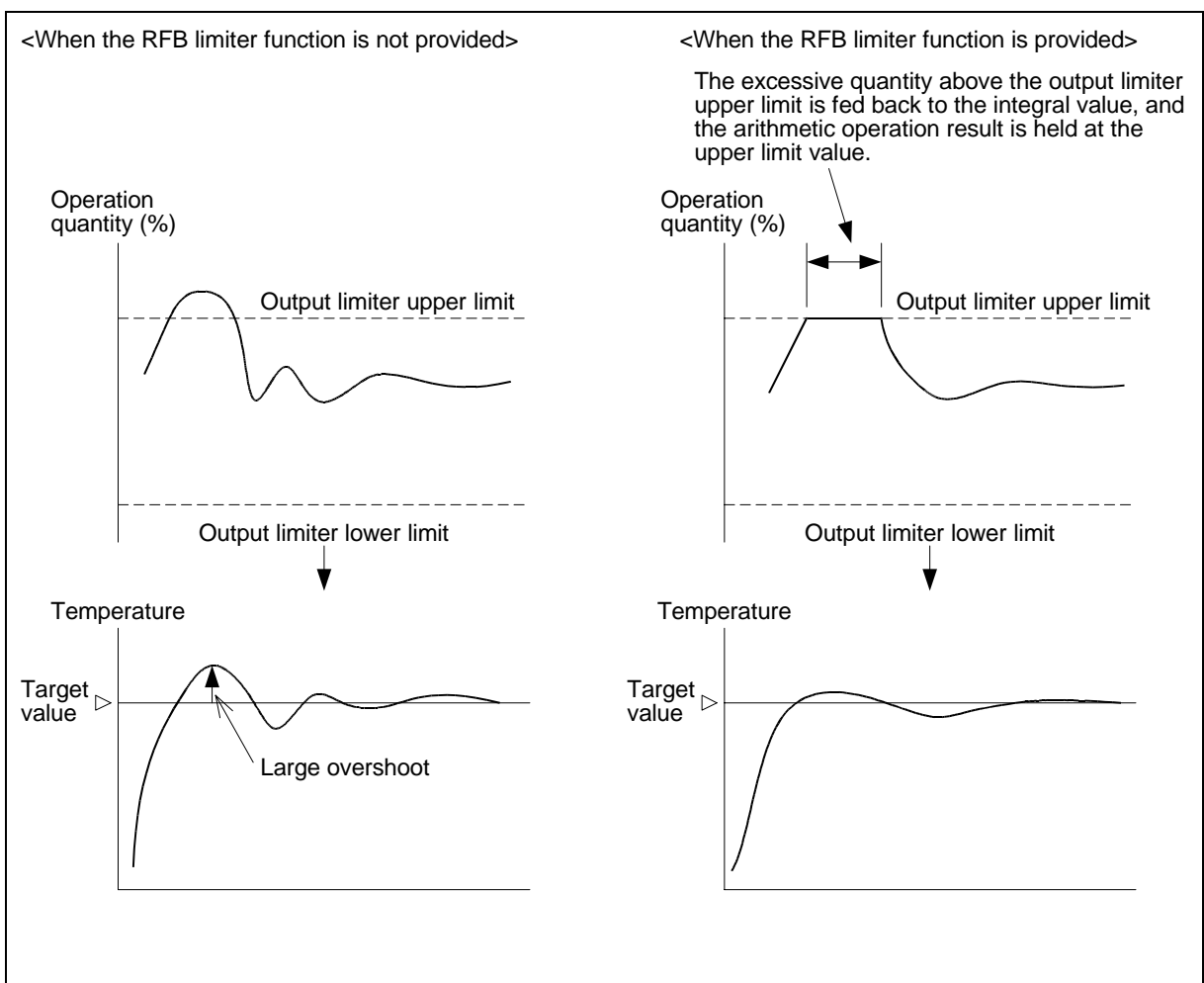

5.2 Two-position control

When the proportional band (P) value is set to "0.0", the FX2N-2LC performs two-position control.

In two-position control, the control output (MV) is set to ON when the measured value (PV) is larger than the temperature set value (SV) or OFF when the measured value (PV) is smaller than the temperature set value (SV).

When the adjustment sensitivity (dead zone) is set, repetitious turning ON/OFF of the output around the temperature set value (SV) can be prevented.

However, if the adjustment sensitivity (dead zone) is set to a large value, upward/downward fluctuation becomes large accordingly. If the adjustment sensitivity (dead zone) is set to a small value, chattering (drastic repetitious turning ON/OFF) may be caused by small oscillations of measured values.

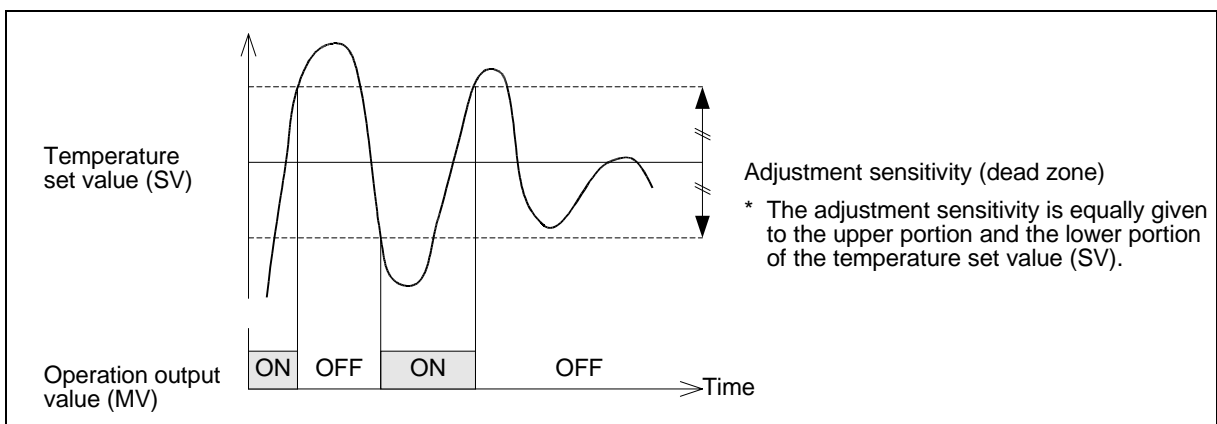

5.3 Auto tuning function

5.3.1 AT (auto tuning)

The AT (auto tuning) function automatically measures, calculates and sets optimal PID constants in accordance with the set temperature.

When the AT execution command (CH1: BFM #20, CH2: BFM #29) is set to "1", auto tuning is performed. (Auto tuning can start from an arbitrary status at any time immediately after the power is turned ON, while the temperature is rising or while control is stable.)

When auto tuning starts, two-position control is performed using the set value (SV). By two-position control, the output is forcedly hunted and its amplitude and oscillation cycle are measured. PID constants are calculated based on the measured values, and stored in each parameter.

The value is set to each parameter within the range shown below.

Table 5.1:

Applicable parameter	Calculated value	Value to be set
Proportional band (BFM #33, #52)	Less than 0.1%	0.1% (0% in version earlier than 1.22)
	1000.0% or more	1000.0%
Integral time (BFM #34, #53)	Less than 1 sec.	1 sec.
	3600 sec. or more	3600 sec.
Derivative time (BFM #35, #54)	3600 sec. or more	3600 sec.

When auto tuning normally finishes, control continues with new calculated PID constants.

While auto tuning is performed, b14 of the event (CH1: BFM #1, CH2: BFM #2) is set to "1".

For auto tuning, the AT bias can be set.

(In order to calculate proper PID constants by auto tuning, set the upper limit of the output limiter to 100%, the lower limit of the output limiter to 0%, and the output change ratio limiter function to OFF.)

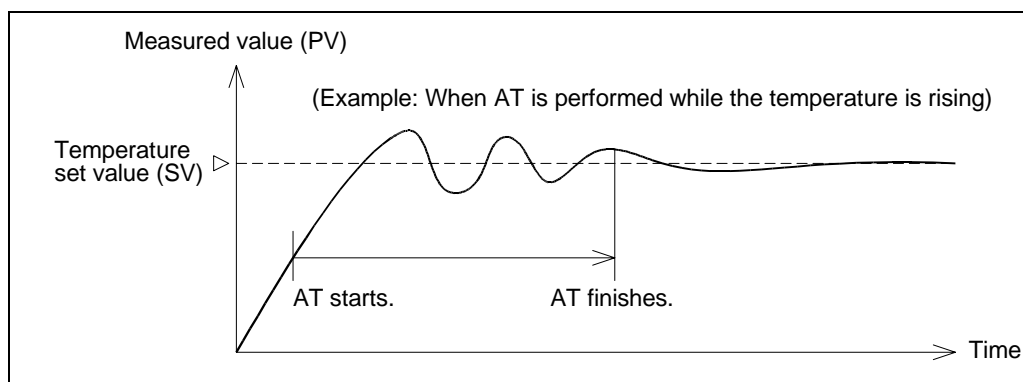

5.3.2 Conditions for performing and aborting AT

- 1) AT can be performed when all the following conditions are satisfied:
 - The control start/stop changeover (BFM #11) set to "1: Starts control".
 - The operation mode (BFM #32, #51) set to "2: Monitor + Temperature alarm + Control".
 - The auto/manual mode changeover (BFM #18, #27) set to "0: AUTO".
 - The measured value PV (BFM #3, #4) is normal.
 - The upper limit (BFM #37, #56) and lower limit (BFM 38, #57) of the output limiter should not be set to the same value.
 - The proportional band (BFM #33, #52) setting is not "0.0 (two-position control)".
- 2) AT is aborted and the 'AT abnormal termination flag (BFM #0 b6:CH1 b7:CH2)' turns ON during either of the following occurrences:
 - The measured value (PV) (BFM #3, #4) becomes abnormal from an incident such as wire disconnection.
 - The set value (SV) (BFM #12, #21) is changed.
 - The control start/stop changeover (BFM #11) is set to "0: Stops control".
 - The input type selection (BFM #70, #71) is changed.
 - The auto/manual mode (BFM #18, #27) is set to "1: MAN".
 - The operation mode (BFM #32, #51) is set to "0: Monitor" or "1: Monitor + Temperature alarm".
 - The AT bias (BFM #45, #64) is changed.
 - The PV bias (BFM #40, #59) is changed.
 - The primary delay digital filter setting (BFM #43, #62) is changed.
 - The upper (BFM #37, #56) and lower limits (BFM 38, #57) of the output limiter are changed.
 - The proportional band (BFM #33, #52) is set to "0.0 (two-position control)".
 - The calculated value of the PID parameters is out of the set range:
 - Proportional band : 0.1 to 1000.0
 - Integral time : 1 to 3600
 - Derivative time : 0 to 3600
 - The AT execution command (BFM #20, #29) is set to "0: Stops auto tuning". (AT abnormal end flag does not turn ON.)
 - Power failure occurs. (AT abnormal flag does not turn ON.)

5.3.3 AT bias

Set the AT bias to perform auto tuning in which the measured value (PV) should not exceed the temperature set value (SV).

The auto tuning function performs two-position control using the temperature set value (SV), hunts the measured value (PV), then calculates and sets each PID constant. However, for some control targets, overshoot caused by hunting is not desirable. Set the AT bias for such a case. When the AT bias is set, the set value (SV) (AT point) with which auto tuning is performed can be changed.

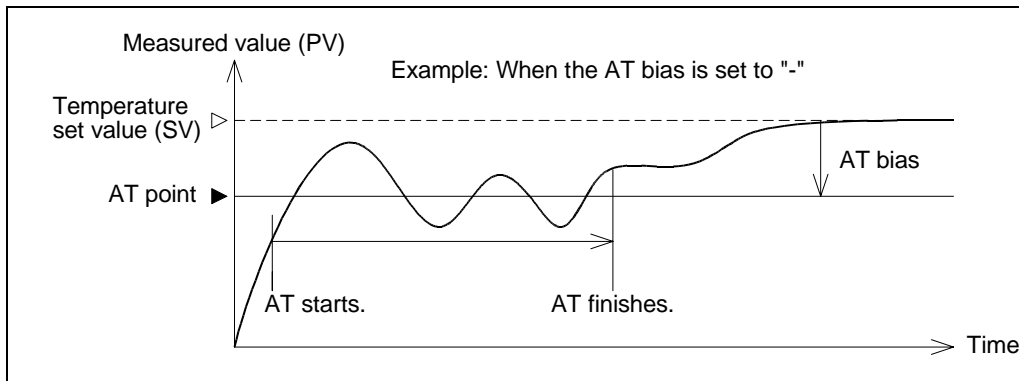

5.4 Auto / manual

5.4.1 Auto mode and manual mode

The mode can be changed over between "auto" and "manual". In the auto mode, the control output value (MV) is set to the output quantity automatically calculated in accordance with the temperature set value (SV). In the manual mode, the control output value (MV) is set to the output quantity set arbitrarily and manually.

In the manual mode, b13 (manual mode transition completion) of the event (CH1: BFM #1, CH2: BFM #2) becomes "1" to notify the manual mode.

0.5 second is required to change over the mode. During changeover, the balance-less, bump-less function is actuated.

Auto mode

In the auto mode, the measured value (PV) is compared with the temperature set value (SV), and the control output (MV) is given by PID arithmetic operation.

This mode is selected when the FX2N-2LC is shipped.

In the auto mode, the manual output value is always set to the output value (MV).

Manual mode

In the manual mode, the output (MV) value is fixed to a certain value.

By changing the manual output setting (BFM #19, BFM #28), the output value can be fixed to an arbitrary value.

The manual output value can be changed while b13 of the event (CH1: BFM #1, CH2: BFM #2) is "1" (that is, when the manual mode is selected).

Even in the manual mode, the temperature alarm function is effective.

5.4.2 Balance-less, bump-less function

The balance-less, bump-less function prevents overload caused by drastic change in the control output value (MV) when the mode is changed over from auto to manual (or from manual to auto).

Operation performed when the mode is changed over from auto to manual:

The control output value in the auto mode continues to be effective.

Operation performed when the mode is changed over from manual to auto:

The control output value is changed over to a value automatically calculated based on the temperature set value (SV).

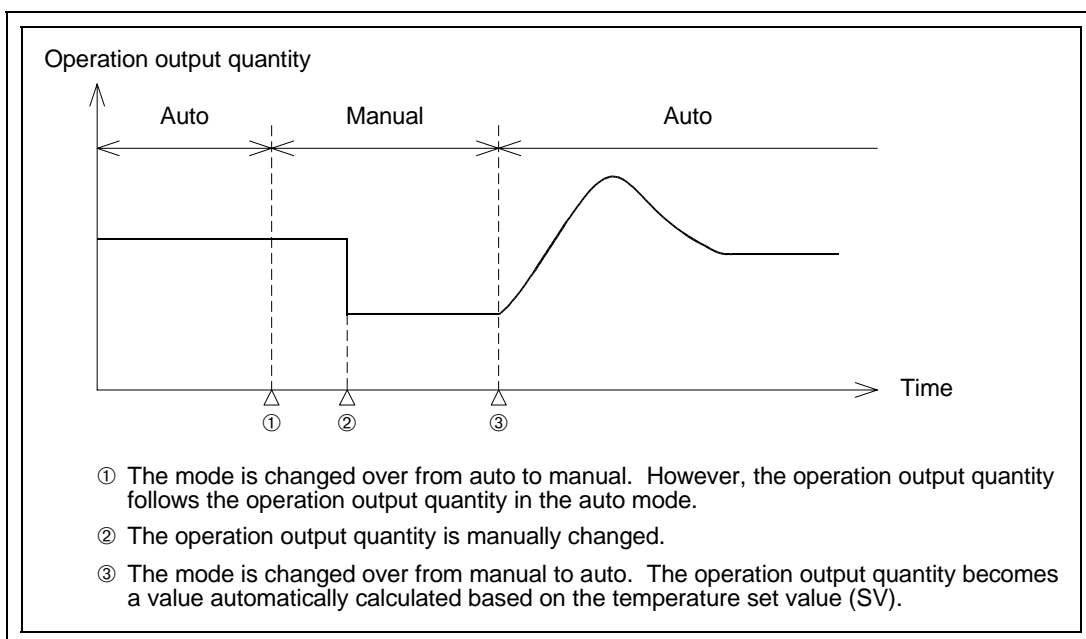

5.5 Heater disconnection alarm function

The heater disconnection alarm function detects the current flowing in the load using a current detector (CT), it compares the detected value (heater current measured value) with the current value set for heater disconnection alarm, and issues an alarm when the measured value is more than or less than the current set value for the heater disconnection alarm.

The heater current can be measured using buffer memories (BFM #7, BFM #8).

Connection example

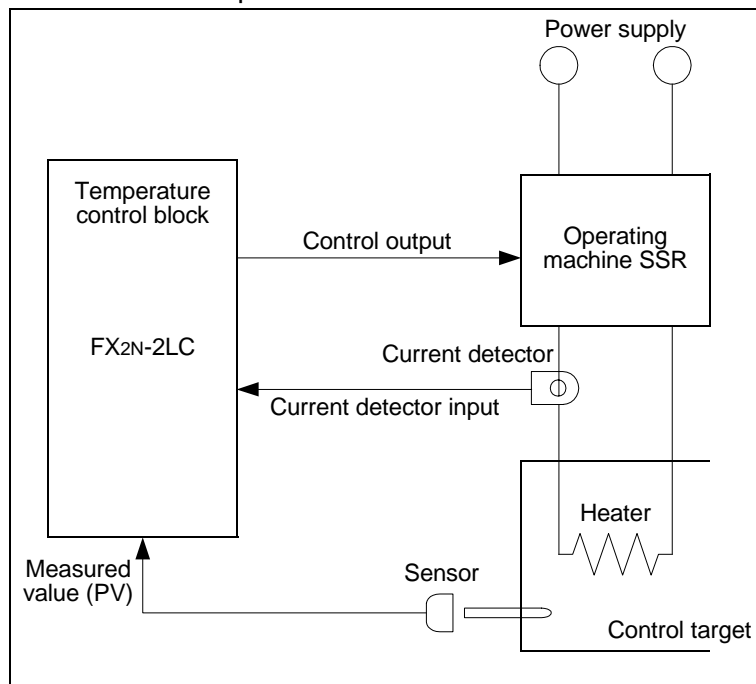

Alarm operation

The heater disconnection alarm function issues an alarm in the following cases.

1) When the heater current does not flow

... Caused by heater disconnection, error in operating machine, etc.

When the reference heater current value is equivalent to or less than the current set value for the heater disconnection alarm while the control output is ON, an alarm is issued.

However, if the control output ON time is 0.5 sec or less, heater disconnection alarm function is not issued.

2) When the heater current does not turn OFF

... Caused by a molten relay, etc.

When the reference heater current value is more than the current set value for the heater disconnection alarm while the control output is OFF, an alarm is issued.

However, if the control output OFF time is 0.5 sec or less, heater disconnection alarm function is not issued.

- The current set value for the heater disconnection alarm should be set below the actual current value of the heater.

Current detector

CTL-12-S36-8 (Applicable current range: 0.0 to 100.0 A)

CTL-6-P-H (Applicable current range: 0.0 to 30.0 A)

Manufacturer: U.R.D. Co., Ltd.

5.6 Loop breaking alarm function (LBA)

The loop breaking alarm function starts to detect the variation of the measured value (PV), at every loop breaking alarm judgment time when the output becomes more than 100% (or the output limiter upper limit) or less than 0% (or the output limiter lower limit), then sets to ON the loop breaking alarm (CH1: BFM #1 b8, CH2: BFM #2 b8) when judging that there is an abnormality in the control loop.

Abnormality judgment criteria

Table 5.2: Heating control (reverse operation)

When output is less than 0% or output limiter lower limit	When measured value (PV) does not decrease at least by loop breaking change criteria (2 °C) within loop breaking set time, an alarm is issued.
When output is more than 100% or output limiter upper limit	When measured value (PV) does not increase at least by loop breaking change criteria (2 °C) within loop breaking set time, an alarm is issued.

Table 5.3: Cooling control (normal operation)

When output is less than 0% or output limiter lower limit	When measured value (PV) does not decrease at least by loop breaking change criteria (2 °C) within loop breaking set time, an alarm is issued.
When output is more than 100% or output limiter upper limit	When measured value (PV) does not increase at least by loop breaking change criteria (2 °C) within loop breaking set time, an alarm is issued.

Abnormality targets

- 1) Abnormality in control target: Heater disconnection, lack of power supply, wiring mistake, etc.
- 2) Abnormality in sensor: Sensor disconnection, short-circuit, etc.
- 3) Abnormality in operating machine: Molten relay, wiring mistake, etc.
- 4) Abnormality in output circuit: Molten relay inside instrument, etc.
- 5) Abnormality in input circuit: No change in the measured value (PV) even after input has changed

Note:

- When the auto tuning function is used, the LBA set time is automatically set to the integral time result multiplied by 2.
The LBA set time does not change even if the integral value changes.
- While auto tuning is performed, the loop breaking alarm function is disabled.
- If the LBA set time is too short or is not suitable to control targets, the loop breaking alarm may repeatedly turn on and off or may not turn ON.
In such a case, change the LBA set time in accordance with the situation.
- The loop breaking alarm function judges abnormalities in the control loop, but cannot detect positions in which abnormalities occur.
Check each part of the control system in turn.

MEMO

1	Introduction
2	Product Configuration
3	Specifications
4	Wiring
5	Introduction of Functions
6	Alarm
7	Buffer Memory (BFM)
8	Program Example
9	Diagnostic

6. Alarm

The FX2N-2LC is equipped with 14 types of alarms. Among them, up to 4 types can be used in accordance with the application.

The alarm types to be used can be selected using buffer memories. The result of each alarm is written to BFM #1 and BFM #2, and can be read in the PLC main unit.

When the measured value (PV) is near the alarm set value of an used alarm type, the alarm status and the non-alarm status may be repeated by fluctuation in inputs. In order to cope with such a case, the alarm dead zone can be set to prevent repeating of the alarm status and the non-alarm status. (The dead zone of alarms 1 to 4 can be set using BFM #76.)

Table 6.1:

Alarm No.	Alarm type	Description	Set range
0	Alarm function OFF	Alarm function is disabled.	---
1	Upper limit input value alarm	When measured value (PV) is more than alarm set value, an alarm is issued.	Input range
2	Lower limit input value alarm	When measured value (PV) is less than alarm set value, an alarm is issued.	Input range
3	Upper limit deviation alarm	When deviation (= Measured value (PV) - Set value (SV)) is more than alarm set value, an alarm is issued.	±Input width
4	Lower limit deviation alarm	When deviation (= Measured value (PV) - Set value (SV)) is less than alarm set value, an alarm is issued.	±Input width
5	Upper/lower limit deviation	When absolute deviation (= Measured value (PV) - Set value (SV)) is more than alarm set value, an alarm is issued.	+Input width
6	Range alarm	When absolute deviation (= Measured value (PV) - Set value (SV)) is less than alarm set value, an alarm is issued.	+Input width
7	Upper limit input value alarm with wait	When measured value (PV) is more than alarm set value, an alarm is issued. However, when power is turned ON, measured value is ignored.	Input range
8	Lower limit input value alarm with wait	When measured value (PV) is less than alarm set value, an alarm is issued. However, when power is turned ON, measured value is ignored.	Input range
9	Upper limit deviation value alarm with wait	When deviation (= Measured value (PV) - Set value (SV)) is more than alarm set value, an alarm is issued. However, when power is turned ON, measured value is ignored.	±Input width
10	Lower limit deviation value alarm with wait	When deviation (= Measured value (PV) - Set value (SV)) is less than alarm set value, an alarm is issued. However, when power is turned ON, measured value is ignored.	±Input width
11	Upper/lower limit deviation value alarm with wait	When absolute deviation (= Measured value (PV) - Set value (SV)) is more than alarm set value, an alarm is issued. However, when power is turned ON, measured value is ignored.	+Input width

Table 6.1:

Alarm No.	Alarm type	Description	Set range
12	Upper limit deviation value alarm with re-wait	When deviation (= Measured value (PV) - Set value (SV)) is more than alarm set value, an alarm is issued. However, when power is turned ON and when set value is changed, measured value is ignored.	\pm Input width
13	Lower limit deviation value alarm with re-wait	When deviation (= Measured value (PV) - Set value (SV)) is less than alarm set value, an alarm is issued. However, when power is turned ON and when set value is changed, measured value is ignored.	\pm Input width
14	Upper/lower limit deviation value alarm with re-wait	When absolute deviation (= Measured value (PV) - Set value (SV)) is more than alarm set value, an alarm is issued. However, when power is turned ON and when set value is changed, measured value is ignored.	+Input width

Input range: Numeric value from the lower limit to the upper limit of input value

Input width: Width from the lower limit to the upper limit of input value (Input width = Upper limit value - Lower limit value)

\pm Input width ...Both a positive and negative numeric values can be set.

+ Input width ...Only a positive numeric value can be set.

Upper limit input value alarm

When the measured value (PV) is more than the alarm set value, an alarm is issued.

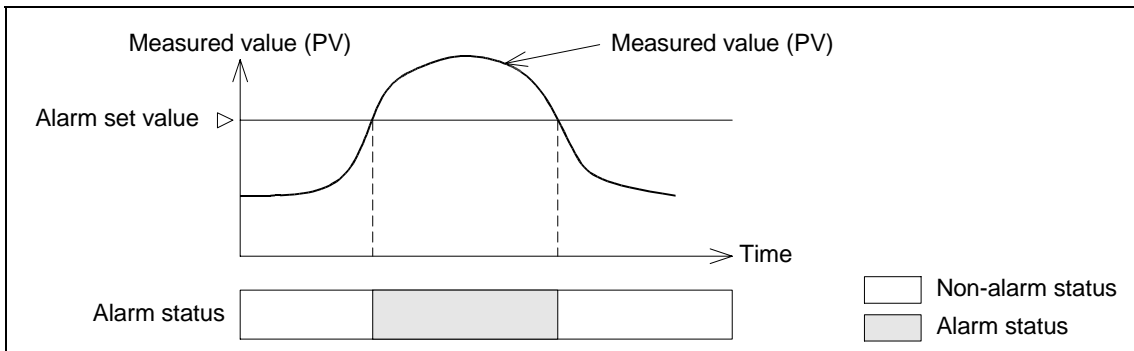

Lower limit input value alarm

When the measured value (PV) is less than the alarm set value, an alarm is issued.

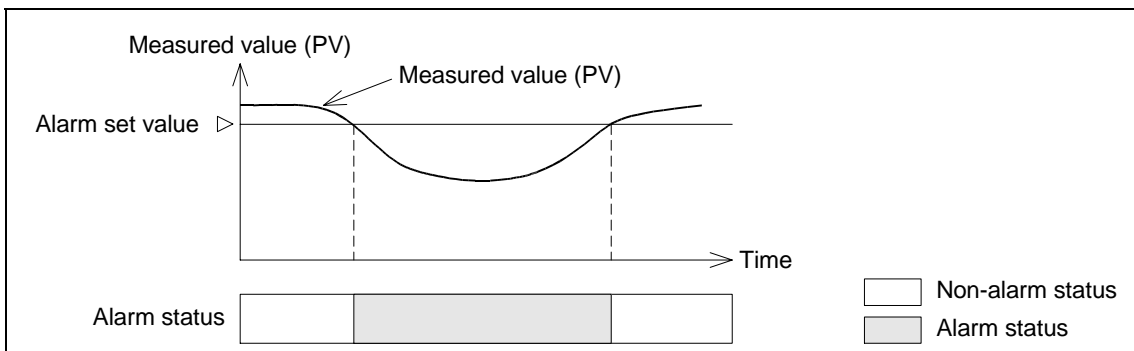

6

Upper limit deviation alarm

When the deviation (= Measured value (PV) - Set value (SV)) is more than the alarm set value, an alarm is issued.

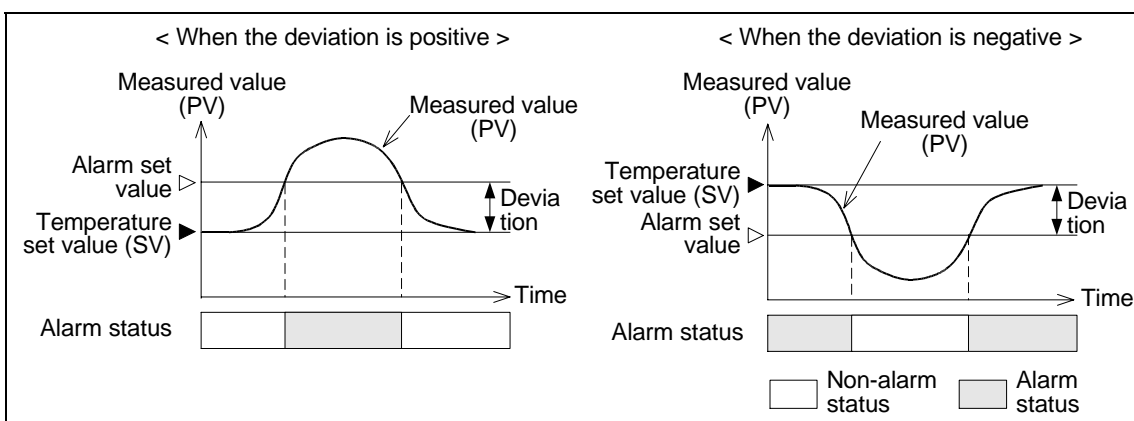

Lower limit deviation alarm

When the deviation ($= \text{Measured value (PV)} - \text{Set value (SV)}$) is less than the alarm set value, an alarm is issued.

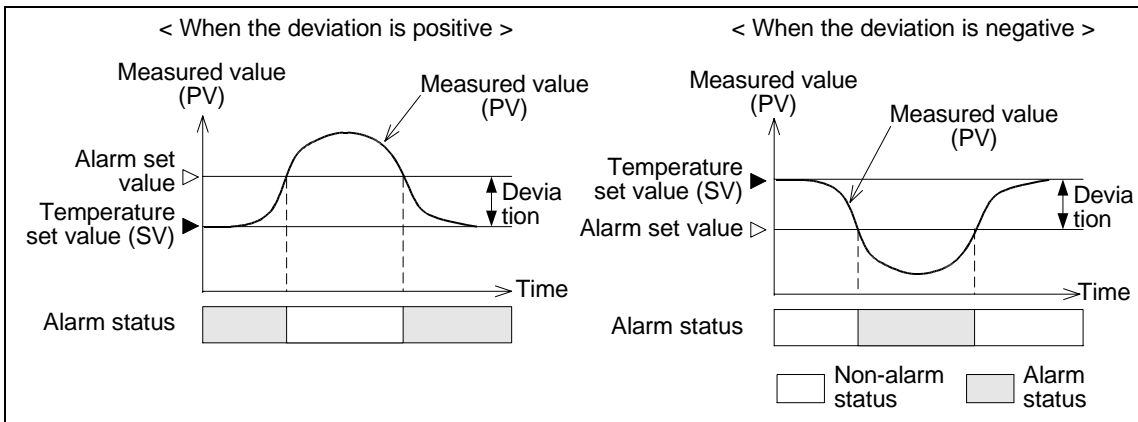

Upper/lower limit deviation alarm

When the absolute deviation ($= |\text{Measured value (PV)} - \text{Set value (SV)}|$) is more than the alarm set value, an alarm is issued.

For example, if the alarm set value is "+10 °C", an alarm is issued when the measured value (PV) is outside the range from "set value (SV) + 10 °C" to "set value (SV) - 10 °C".

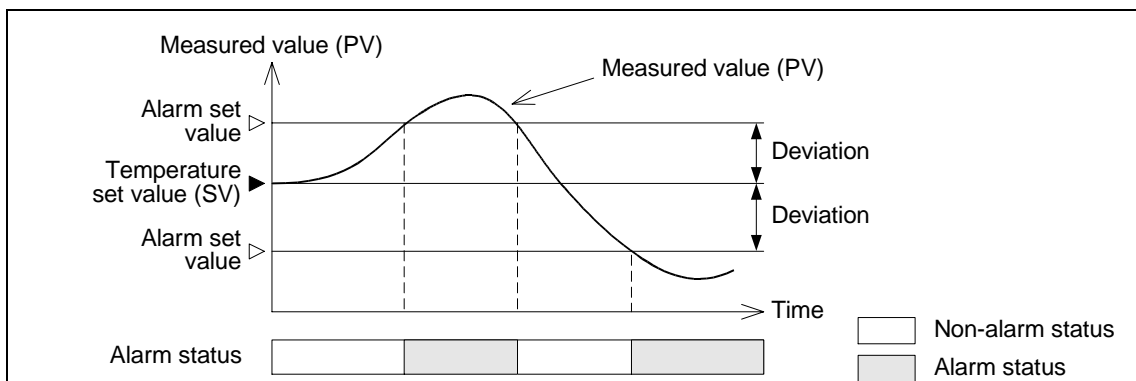

Range alarm

When the absolute deviation ($= |\text{Measured value (PV)} - \text{Set value (SV)}|$) is less than the alarm set value, an alarm is issued.

For example, if the alarm set value is "+10 °C", an alarm is issued when the measured value (PV) is inside the range from "set value (SV) + 10 °C" to "set value (SV) - 10 °C".

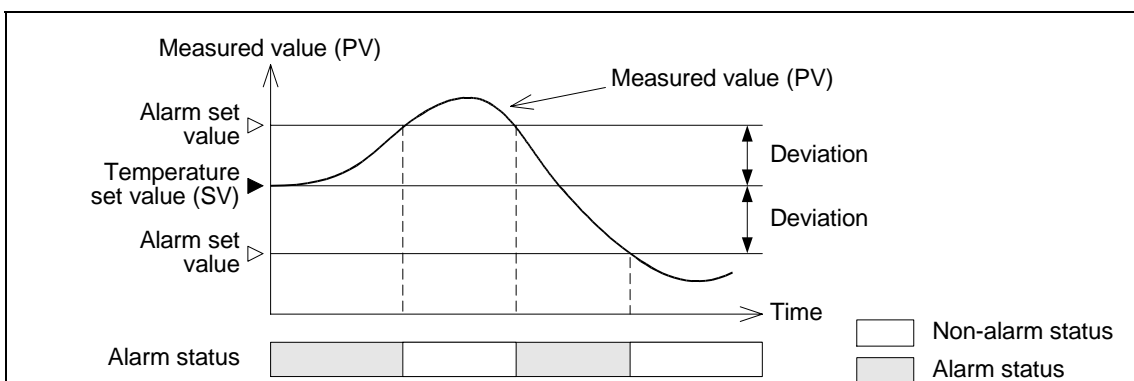

Alarm wait operation

The wait operation ignores the alarm status of the measured value (PV) occurred when the power is turned ON, and disables the alarm function until the measured value (PV) goes out of the alarm status once.

When control starts, the wait operation is performed also.

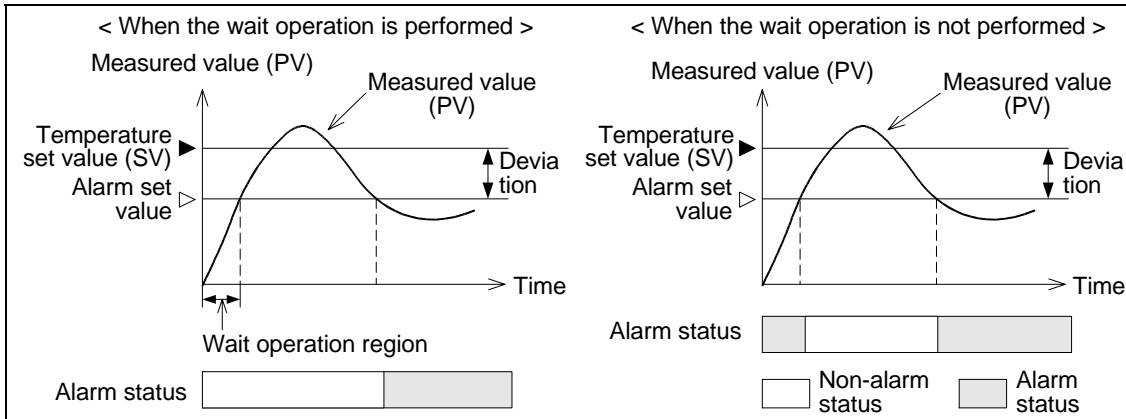

Alarm re-wait operation

The alarm re-wait operation ignores the alarm status of the measured value (PV) occurred when the power is turned ON, and disables the alarm function until the measured value (PV) goes out of the alarm status once.

When the temperature set value (SV) is changed, the measured value (PV) for deviation alarm changes accordingly. At this time, even if the measured value (PV) becomes the alarm status, the alarm re-wait function ignores it again and disables the alarm function until the measured value (PV) goes out of the alarm status again.

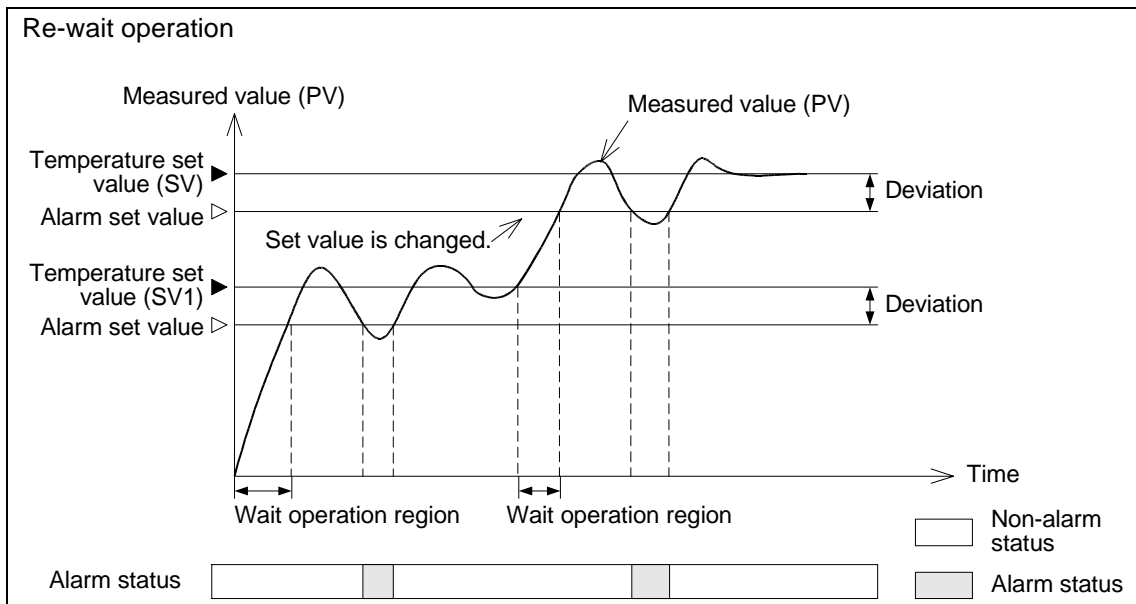

MEMO

1	Introduction
2	Product Configuration
3	Specifications
4	Wiring
5	Introduction of Functions
6	Alarm
7	Buffer Memory (BFM)
8	Program Example
9	Diagnostic

7. Buffer Memory (BFM)

Each setting and alarm in the FX₂N-2LC is written from or read to the PLC main unit through buffer memories (hereafter referred to as "BFM").

Each BFM consists of 16 bits. Use FROM/TO instructions in the 16-bit format.

7.1 Buffer memory list

Table 7.1:

BFM No.		Name	Description/set range	Initial value	Remarks		
CH1	CH2						
#0		Flag	Error flag, ready flag, etc.	0	R	---	
#1	#2	Event	Alarm status, temperature rise completed status, etc.	0		---	
#3	#4	Measured value (PV)	±5% of input range (°C/°F)	0.0		■	
#5	#6	Control output value (MV)	-5.0 to 105.0 (%)	-5.0		▲	
#7	#8	Heater current measured value	0.0 to 105.0 (A)	0.0		▲	
#9		Initialization command	0: Performs nothing 1: Initializes all data 2: Initializes BFM #10 to BFM #69	0	R/W	---	
#10		Error reset command	0: Performs nothing 1: Resets errors	0		---	
#11		Control start/stop changeover	0: Stops control 1: Starts control	0		---	
#12	#21	Set value (SV)	Within set range limiter	0.0		■	
#13	#22	Alarm 1 set value	Unit: °C or °F Allowable set range varies depending on alarm mode setting.	0.0		■	
#14	#23	Alarm 2 set value		0.0		■	
#15	#24	Alarm 3 set value		0.0		■	
#16	#25	Alarm 4 set value		0.0		■	
#17	#26	Heater disconnection alarm set value	0.0 to 100.0 A (When "0.0" is set, alarm function is disabled.)	0.0		☆	▲
#18	#27	Auto/manual mode changeover	0:AUTO 1:MAN	0			
#19	#28	Manual output set value	-5.0 to 105.0 (%) *1	0.0			▲
#20	#29	Auto tuning execution command	0: Stops auto tuning 1: Performs auto tuning	0		---	
#30		Unit type code	2060		R	---	
#31		Prohibited	---	---	---	---	
#32	#51	Operation mode	0: Monitor 1: Monitor + Temperature alarm 2: Monitor + Temperature alarm + Control	2	R/W	---	
#33	#52	Proportional band	0.0 to 1,000.0 (% of input span) (When "0.0" is set, two-position control is performed.)	3.0		☆	▲
#34	#53	Integral time	1 to 3,600 sec	240			---
#35	#54	Derivative time	0 to 3,600 sec	60			---

Table 7.1:

BFM No.		Name	Description/set range	Initial value	Remarks		
CH1	CH2						
#36	#55	Control response parameter	0: Slow 1: Medium 2: Fast	0	R/W	☆	---
#37	#56	Output limiter upper limit	Output limiter lower limit to 105.0 (%)	100.0			▲
#38	#57	Output limiter lower limit	-5.0% to output limiter upper limit	0.0			▲
#39	#58	Output change ratio limiter	0.0 to 100.0 %/sec (When "0.0" is set, function is disabled.)	0.0			▲
#40	#59	Sensor correction value setting (PV bias)	±50.00 (% of input span)	0.00			▲
#41	#60	Adjustment sensitivity (dead zone) setting	0.0 to 10.0 (% of input span)	1.0			▲
#42	#61	Control output cycle setting	1 to 100 sec	30			---
#43	#62	Primary delay digital filter setting	0 to 100 sec (When "0" is set, function is disabled.)	0			---
#44	#63	Setting change ratio limiter	0.0 to 100.0 %/min (When "0.0" is set, function is disabled.)	0.0			▲
#45	#64	AT (auto tuning) bias	±Input span (°C/°F)	0.0			■
#46	#65	Normal/reverse operation selection	0: Normal operation 1: Reverse operation	1			---
#47	#66	Setting limiter upper limit	Setting limiter lower limit to input range upper limit	1300			■
#48	#67	Setting limiter lower limit	Input range lower limit to setting limiter upper limit	-100			■
#49	#68	Loop breaking alarm judgement time	0 to 7,200 sec (When "0" is set, alarm function is disabled.)	480			---
#50	#69	Loop breaking alarm dead zone	0.0 or 0 to input span (°C/°F)	0.0			■
#70	#71	Input type selection	0 to 43	2			---
#72	Alarm 1 mode setting		0 to 14	0			---
#73	Alarm 2 mode setting			0			---
#74	Alarm 3 mode setting			0			---
#75	Alarm 4 mode setting			0			---
#76	Alarm 1/2/3/4 dead zone setting		0.0 to 10.0 (% of input span)	1.0	▲		
#77	Number of times of alarm 1/2/3/4 delay		0 to 255 times	0	---		
#78	Number of times of heater disconnection alarm delay		3 to 255 times	3	---		
#79	Temperature rise completion range setting		Integer 1 to 10 (°C/°F)	10	---		
#80	Temperature rise completion soak time		0 to 3600 (sec)	0	---		

Table 7.1:

BFM No.		Name	Description/set range	Initial value	Remarks		
CH1	CH2						
#81		CT monitor method changeover	0: Monitors both ON current and OFF current. 1: Monitors only ON current.	0	R/W		---
#82		Set value range error address	0: Normal 1 or another numeric value : Setting error address	0	R	☆	---
#83		Set value backup command	0: Normal 1: Starts to write EEPROM.	0	R/W		---

R : Only read is enabled.

R/W: Both read and write are enabled.

☆ : Setting data can be backed up by EEPROM in accordance with the setting of BFM #83.

*1 : Write is enabled when the manual mode transition completion flag is ON.

■ : Handling numbers containing decimal places
The set value should be the actual value multiplied by ten (multiplied by 100 for BFM #40 and #59).
Example: 100.0 (actual value) → 1000 (set value)

▲ : Handling integers or numbers containing decimal places according to the input sensor type (setting of BFM #70 and #71).
When handling numbers containing decimal places, multiply the set value by ten.

- As to a numeric value containing a decimal point and numbers after that, set it as a value multiplied by 10.
Example: 100.0 (actual value) → 1000 (set value)
- If a value is written by mistake to a buffer memory used only for read, the written value is ignored. And 500 ms later, the buffer memory is overwritten with a correct value.
- If a value outside the allowable set range is written to a buffer memory used both for read and write, the set value range error (b1) of the flag (BFM #0) turns ON.
And the buffer memory in which the set value range error has occurred is controlled with the upper limit or the lower limit of the allowable set range.

7.2 Details of buffer memories

7.2.1 BFM #0: Flag

Table 7.2:

Bit No.	Description	Operation
b0	Error present	Turns ON when an error among b1 to b10 below has occurred.
b1	Set value range error	Turns ON when data outside set range is written.
b2	24 VDC power supply error	Turns ON when driving power supply (24 VDC) is not supplied.
b3	Set value backup error	Turns ON when an error has been caused by noise or when a failure has occurred in FX2N-2LC. If contents of error are not eliminated even after power is turned OFF once then ON again, contact Mitsubishi Electric System Service.
b4	Unused	---
b5	Unused	---
b6	AT abnormal end flag (CH1) (Applicable to Ver. 1.22 or later)	Each bit turns ON when AT abnormally ends. The alarm can be reset by set a value of 0 to the AT execution command. See Ch. 5.3.
b7	AT abnormal end flag (CH2) (Applicable to Ver. 1.22 or later)	
b8	Sum check error for adjustment data error	Turns ON when an error has been caused by noise or when a failure has occurred in FX2N-2LC. If contents of error are not eliminated even after power is turned OFF once then ON again, contact Mitsubishi Electric System Service.
b9	Cold contact temperature compensation data error	
b10	A/D converted value error	
b11	Unused	---
b12	Controlling flag	Turns ON when FX2N-2LC is performing control.
b13	Set value being backed up	Remains ON while set values are being backed up. Refer to 7.2.42.
b14	Unused	---
b15	Temperature control ready flag	Turns ON when FX2N-2LC becomes ready for operation.

Operation of b15 (Temperature control ready flag)

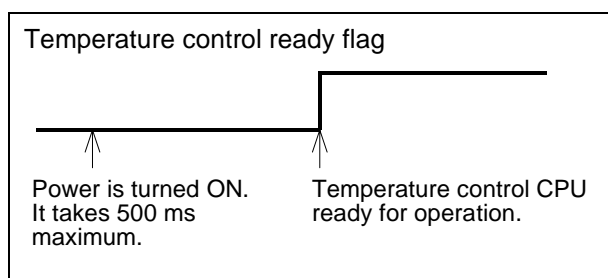

Description on operation

- 1) Once the power has been turned ON the FX2N-2LC is ready. Temperature control ready flag turns ON.
- 2) While the temperature control ready flag is ON, the FX2N-2LC accepts TO instructions.
- 3) The measured data is sampled for nine seconds after the temperature control ready flag turns ON and then stored in BFM #12 and #21.
During this period of time, the ON/OFF operation is not executed.

7.2.2 BFM #1 (CH1) and BFM #2 (CH2): Event

BFM #1 corresponds to CH1. BFM #2 corresponds to CH2. Assignment is equivalent between BFM #1 and BFM #2.

Table 7.3:

Bit No.	Assignment	Description
b0	Input error (upper limit)	Turns ON when input value is over scale.
b1	Input error (lower limit)	Turns ON when input value is under scale.
b2	Cold contact temperature compensation data error	Turns ON when an error has been caused by noise or when a failure has occurred in FX2N-2LC.
b3	A/D converted value error	If contents of error are not eliminated even after power is turned OFF once then ON again, contact Mitsubishi Electric System Service.
b4	Alarm 1	Turns ON when an alarm has occurred.
b5	Alarm 2	Turns ON when an alarm has occurred.
b6	Alarm 3	Turns ON when an alarm has occurred.
b7	Alarm 4	Turns ON when an alarm has occurred.
b8	Loop breaking alarm	Turns ON when a loop breaking alarm has occurred
b9	Heater disconnection alarm	Turns ON when a heater disconnection alarm has occurred.
b10	Heater meltdown alarm	Turns ON when a heater meltdown alarm has occurred.
b11	Output ON/OFF monitor (Applicable to Ver. 1.22 or later)	Turns ON/OFF according to the output status.
b12	Decimal point position (0: Unit = 1°C/°F, 1: Unit = 0.1°C/°F)	Turns ON when input range is set to "0. 1°C/°F".
b13	Manual mode transition completed	Turns ON when transition to manual mode is completed. Only while b13 is ON, manual output set value can be written.
b14	AT (auto tuning) being performed	Remains ON while auto tuning is being performed.
b15	Temperature rise completed status	Turns ON after soak time (BFM #80) is finished within temperature rise completion range (BFM #79).

Operation of b15 (temperature rise completed status)

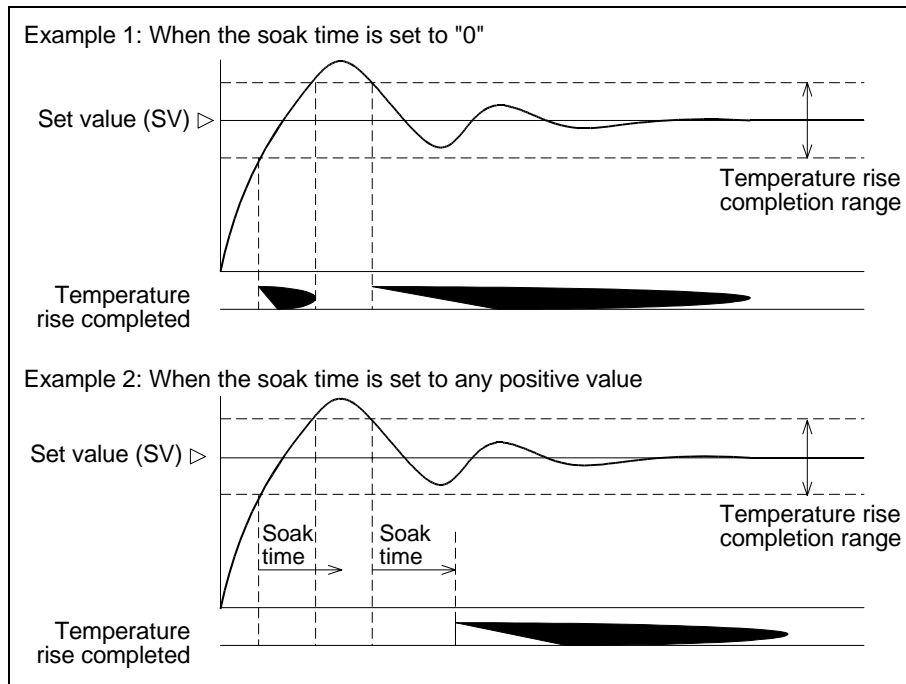

This bit notifies that the measured value (BFM #3, BFM #4) reaches near the set value (BFM #12, BFM #21).

When the measured value reaches the temperature rise completion range (BFM #79) and the soak time (BFM #80) is finished, b15 of the event (BFM #1, BFM #2) turns ON.

7.2.3 BFM #3 (CH1) and BFM #4 (CH2): Measured value (PV)

BFM #3 stores the measured value for CH1. BFM #4 stores the measured value for CH2. The units are °C, 0.1°C, °F or 0.1°F in accordance with the setting of the input type selection (BFM #70, BFM #71).

When the power is turned ON, the measured value is stored in each of the mentioned BFMs after nine seconds of sampling time.

7.2.4 BFM #5 (CH1) and BFM #6 (CH2): Control output value (MV)

BFM #5 stores the control output value (output ON ratio) of CH1. BFM #6 stores the control output value (output ON ratio) of CH2.

The display range is from -5.0 to +105.0%.

7.2.5 BFM #7 (CH1) and BFM #8 (CH2): Heater current measured value

BFM #7 stores the heater current measured value of CH1 input from CT. BFM #8 stores the heater current measured value of CH2 input from CT.

The display range is from 0.0 to +105.0 A.

7.2.6 BFM #9: Initialization command

In BFM #9, initialize the set values.

When BFM #9 is set to "K0 (initial value)", the initialization command is disabled.

When BFM #9 is set to "K1", addresses 10 to 81 are set to the initial values.

When BFM #9 is set to "K2", addresses 10 to 69 are set to the initial values.

- When BFM #9 is set to "K1" or "K2", initialization is completed and BFM #9 retains a value of "K0" automatically.
- The initial value of the setting limiter's upper/lower limits are the input range's upper/lower limits.
- Initialization takes 500 ms maximum. Do not activate FROM/TO instructions on the BFM being initialized.

7.2.7 BFM #10: Error reset command

In BFM #10, reset errors.

When BFM #10 is set to "K1", all errors occurred in BFM #0 are reset.

If the causes of an error are not eliminated, the corresponding error bit turns ON again.

The error reset command is not automatically set when another error has occurred. Thus, set BFM #10 to "K0" once again. (In order to execute the error reset command, set BFM #10 to "K1" for 0.5 seconds or longer.)

7.2.8 BFM #11: Control start/stop changeover

When BFM #11 is set to "K0 (initial value)", control stops.

When BFM #11 is set to "K1", control starts.

When the PLC main unit is changed over from "RUN" to "STOP", outputs of the FX2N-2LC are held.

In order to stop outputs of the FX2N-2LC, make sure to use BFM #11.

7.2.9 BFM #12 (CH1) and BFM #21 (CH2) : Set value (SV)

BFM #12 stores the set value of CH1. BFM #21 stores the set value of CH2.

The unit is °C, 0.1°C, °F or 0.1°F in accordance with the setting of the input type selection (BFM #70, BFM #71).

The allowable set range is the selected input range.

When the setting limiter (CH1: BFM #47 and BFM #48, CH2: BFM #66 and BFM #67) is set, the allowable set range corresponds to the setting limiter.

7.2.10 BFM #13 to BFM #16 (CH1) and BFM #22 to BFM #25 (CH2): Alarm 1/2/3/4 set value

In BFM #13 to BFM #16 and BFM #22 to BFM #25, write the set value of each alarm selected by the alarm 1/2/3/4 mode setting (BFM #72 to BFM #75).

In the alarm 1/2/3/4 mode setting, four among 14 alarm types can be arbitrarily selected.

BFM #13 to BFM #16 (CH1) and BFM #22 to BFM #25 (CH2) are assigned to the alarm 1 mode, the alarm 2 mode, the alarm 3 mode and the alarm 4 mode respectively in the ascending order of BFM No. for each channel.

The unit and the allowable range of the set value written to BFM #13 to BFM #16 (CH1) and BFM #22 to BFM #25 (CH2) vary depending on the selected alarm mode. In accordance with the setting of the alarm mode setting (BFM #72 to BFM #75), write a proper set value.

7.2.11 BFM #17 (CH1) and BFM #26 (CH2): Heater disconnection alarm set value

In BFM #17, set a value to recognize heater disconnection in CH1. In BFM #26, set a value to recognize heater disconnection in CH2.

Depending on the output ON/OFF status, the heater's current value for each channel input from the CT and the value set for BFM #17 (CH1) or BFM #26 (CH2), thus, heater disconnection alarm (CH1: BFM #1 b9, CH2: BFM #2 b9) turns ON.

The display range is from 0.0 to 100.0 A.

When BFM #17/#26 is set to "0.0", the heater disconnection alarm function is disabled.

The current set value for the heater disconnection alarm should be set below the actual current value of the heater.

7.2.12 BFM #18 (CH1) and BFM #27 (CH2) : Auto/manual mode changeover

In BFM #18, change over the mode of CH1. In BFM #27, change over the mode of CH2.

When BFM #18/#27 is set to "K0 (initial value)", the auto mode is selected.

When BFM #18/#27 is set to "K1", the manual mode is selected.

Auto mode:

The measured value (PV) is compared with the temperature set value (SV), PID arithmetic operation is performed, then the control output (MV) is given.

In the auto mode, the manual output set value (CH1: BFM #19, CH2: BFM #28) is always equivalent to the control output value.

Manual mode:

The control output (MV) value is fixed to the manual output set value (CH1: BFM #19, CH2: BFM #28).

The manual output set value can be changed while b13 of the event (CH1: BFM #1, CH2: BFM #2) is ON even if operation is performed in the manual mode.

The temperature alarm function is effective even in the manual mode.

7.2.13 BFM #19 (CH1) and BFM #28 (CH2): Manual output set value

In BFM #19 (CH1) and BFM #28 (CH2), set the output ON ratio in the manual mode.

The display range is from -5.0 to +105.0%.

The output ON/OFF cycle (period of time) can be set within the range from 1 to 100 sec using BFM #42 (CH1) and BFM #61 (CH2).

Write the percentage of the ON period of time.

7.2.14 BFM #20 (CH1) and BFM #29 (CH2): Auto tuning execution command

In BFM #20, perform auto tuning of CH1. In BFM #29, perform auto tuning of CH2.

When BFM #20/#29 is set to "K0", auto tuning is stopped.

When BFM #20/#29 is set to "K1", auto tuning is performed.

In order to execute AT again, set BFM #20 and #29 to "K0" after the initial AT is completed (b14 of both BFM #1 and #2 turns OFF) and then set once more to "K1".

7.2.15 BCM#30: Unit type code

BFM #30 stores the unit type code "2060 (fixed value)" of the FX2N-2LC.

7.2.16 BFM #32 (CH1) and BFM #51 (CH2): Operation mode

In BFM #32, select the operation mode of CH1. In BFM #51, select the operation mode of CH2.

When BFM #32/#51 is set to "K0", only monitor is performed. (At this time, the control output remains OFF.)

When BFM #32/#51 is set to "K1", monitor and temperature alarm are performed. (At this time, the control output remains OFF.)

When BFM #32/#51 is set to "K2 (initial value)", all of monitor, temperature alarm and control are performed.

- Monitor: Monitors the measured value (BFM #3/#4).
- Temperature alarm: Monitors the event input error (b0 and b1 of BFM #1 and BFM #2) and alarms 1 to 4 (b4 to b7 of BFM #1 and BFM #2).
- Control: Performs temperature control (PID control) and gives the control output.
- The setting of "K0" to "K2" above is effective only when control starts (BFM #11). While control is stopped, only monitor is performed without regard to the setting described above.

7.2.17 BFM #33 (CH1) and BFM #52 (CH2): Proportional band (P)

In BFM #33, set the proportional band of CH1. In BFM #52, set the proportional band of CH2. The proportional band is required to give the control output in proportion to the deviation (which is the difference between the set value (SV) and the measured value (PV)).

As the proportional band value is larger, changes in the control output value (MV) in response to changes in the input is smaller. On the contrary, as the proportional band value is smaller, changes in the control output value (MV) in response to changes in the input is larger. (Generally, the proportional band is the inverse number of the proportional gain.)

However, if the proportional band value is too large, overshoot becomes large and it takes considerable time until the output is stabilized at the set value.

The allowable set range is from 0.0 to 1,000.0%.

When BFM #33/#52 is set to "0.0", two-position control is performed.

7.2.18 BFM #34 (CH1) and BFM #53 (CH2): Integral time (I)

In BFM #34, set the integral time of CH1. In BFM #53, set the integral time of CH2.

The integral operation changes the operation quantity in proportion to the area enclosed by the deviation size and the period of time in which deviation is generated.

In the proportional operation, even while the operation quantity is stable, deviation (which is the difference between the set value (SV) and the measured value (PV)) may be caused by natural radiation, etc. The integral operation eliminates such a deviation. At this time, the period of time required to obtain, only by the integral operation, the operation quantity equivalent to that obtained by the proportional operation is called the integral time.

As the integral time is shorter, the integral efficiency is better.

The allowable set range is from 0 to 3,600 sec.

7.2.19 BFM #35 (CH1) and BFM #54 (CH2): Derivative time (D)

In BFM #35, set the derivative time of CH1. In BFM #54, set the derivative time of CH2.

The derivative operation changes the operation quantity in proportion to the measured value change speed so that increase of deviation (which is the difference between the set value (SV) and the measured value (PV)) can be prevented from happening.

Because the derivative operation responds to the measured value change ratio, the response to disturbances (turbulence in the measured value caused by external factors) is improved.

When the deviation increases or decreases at a constant ratio, the period of time required to obtain, only by the derivative operation, the operation quantity equivalent to that obtained by the proportional operation is called the derivative time.

As the derivative time is longer, the derivative effect is larger.

The allowable set range is from 0 to 3,600 sec.

When BFM #35/#54 is set to "0", the derivative function is disabled.

7.2.20 BFM #36 (CH1) and BFM #55 (CH2): Control response parameter

In BFM #36, set the control response parameter of CH1. In BFM #55, set the control response parameter of CH2.

The control response parameter selects the response to changes in the temperature set value (SV) in PID control among three steps (slow, medium and fast).

When BFM #36/#55 is set to "K0", the response becomes slow speed.

When BFM #36/#55 is set to "K1", the response becomes medium speed.

When BFM #36/#55 is set to "K2", the response becomes fast speed.

The figure below shows the operation at each setting.

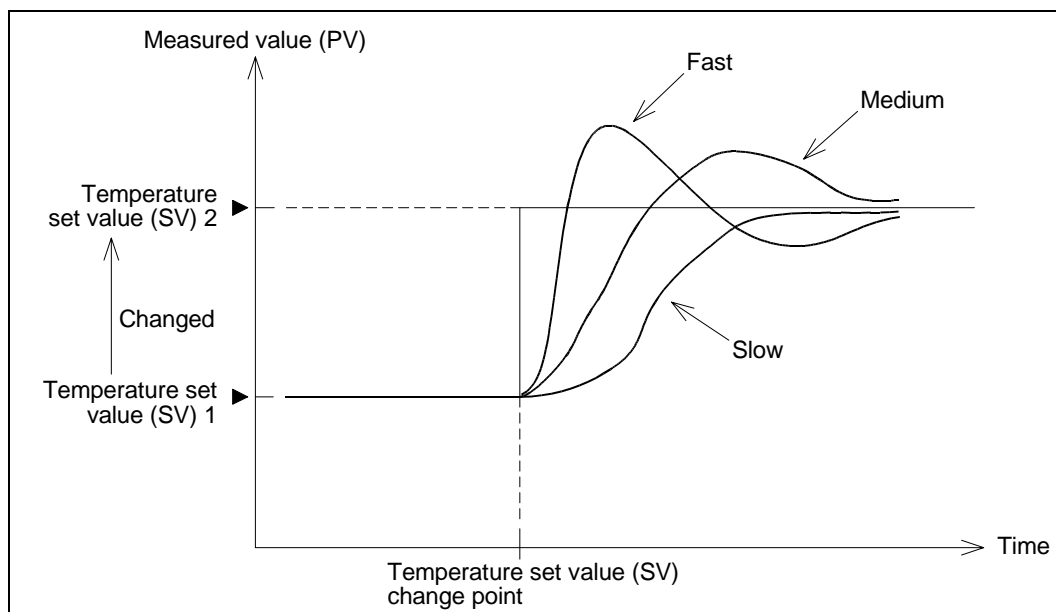

In order to increase the response speed of the control target to changes in the temperature set value (SV), select "fast".

In this case, however, a little overshoot cannot be avoided.

Overshoot is not desirable in some control targets. In order to prevent overshoot, select "slow".

**7.2.21 BFM #37 (CH1) and BFM #56 (CH2): Output limiter upper limit
BFM #38 (CH1) and BFM #57 (CH2): Output limiter lower limit**

In BFM #37 and BFM #56, set the output limiter upper limit of CH1 and CH2 respectively. In BFM #38 and BFM #57, set the output limiter lower limit of CH1 and CH2 respectively. Use these BFM when setting the upper limit and the lower limit for the setting of the control output value (MV) (BFM #5, BFM #6).

The allowable set range of the upper limit is from the output limiter lower limit to +105%. The allowable set range of the lower limit is from -5.0% to the output limiter upper limit.

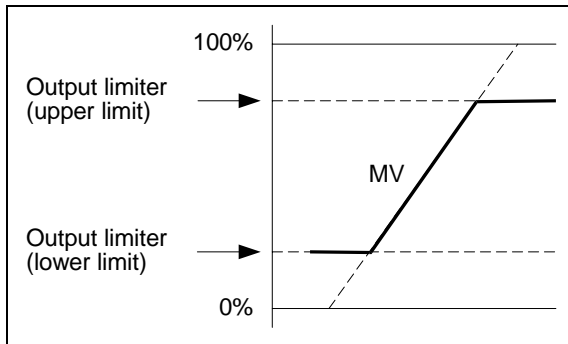

- While the output limiter is effective, proper PID constants may not be obtained during auto tuning.
It is recommended not to use the output limiter when auto tuning is used.
- While two-position control is used, the output limiter is not effective.

7.2.22 BFM #39 (CH1) and BFM #58 (CH2): Output change ratio limiter

In BFM #39, set the output change ratio limiter of CH1. In BFM #58, set the output change ratio limiter of CH2.

The output change ratio limiter function limits the variation of the control output value (MV) per unit time (1 sec). The output is limited in accordance with the preset output change ratio.

The allowable set range is from 0 to 100%.

When BFM #39/#58 is set to "0.0%", the output change ratio limiter function is disabled.

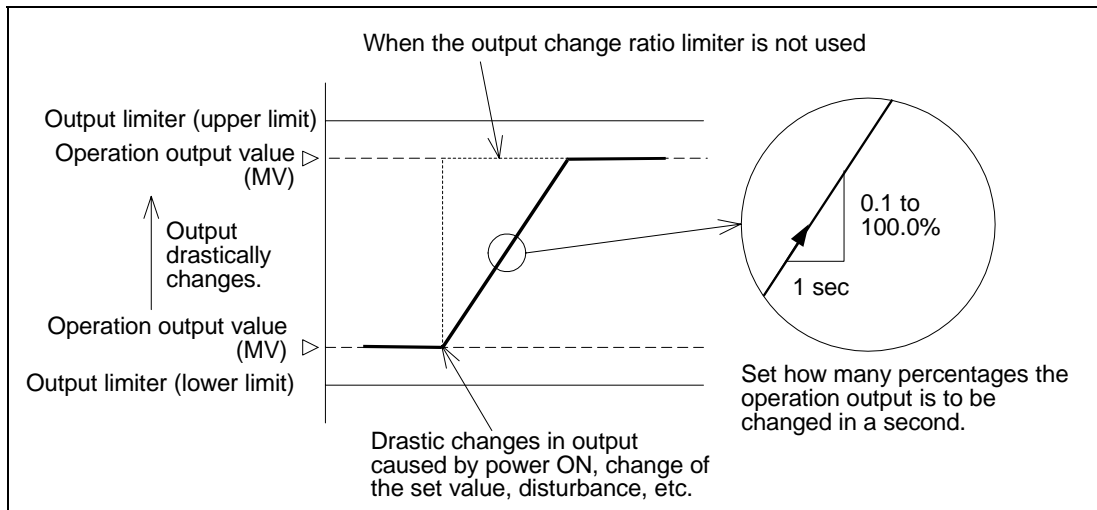

When the power is turned ON (outside the proportional band) or when the set value is considerably changed, the output does not drastically change but is performed in accordance with the preset inclination.

- When the output change ratio limiter is set to a small value (that is, when the inclination is small), the control response becomes slow and the effect of differential is eliminated.
- While two-position control is performed, the output change ratio limiter is disabled.
- While the output change ratio limiter is effective, proper PID constants may not be obtained during auto tuning. It is recommended not to use the output change ratio limiter when auto tuning is used.

7.2.23 BFM #40 (CH1) and BFM #59 (CH2): Sensor correction value setting (PV bias)

In BFM #40, set the sensor correction value of CH1. In BFM #59, set the sensor correction value of CH2.

The actual input value is added (corrected) by the sensor correction value, then stored as the measured value (BFM #3, BFM #4).

Use this correction value to correct the dispersion among sensors and the difference in the measured value (PV) from those by other instruments.

The allowable set range is $\pm 50.00\%$.

Example

Condition: To correct 2 °C in the range span of 400 °C

At this time, the sensor correction value is as follows.

$$\text{Sensor correction value} = 2 \text{ °C} / 400 \text{ °C} \times 100 = 0.5\%$$

The display value is as follows.

$$\text{Display value} = \text{Measured value (PV)} + \text{Sensor correction value}$$

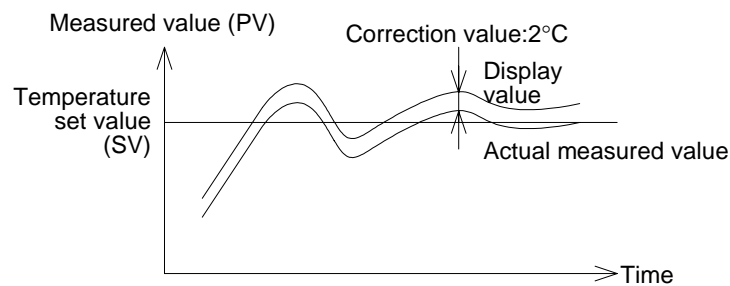

7.2.24 BFM #41 (CH1) and BFM #60 (CH2): Adjustment sensitivity (dead zone) setting

In BFM #41, set the adjustment sensitivity (dead zone) of CH1. In BFM #60, set the adjustment sensitivity (dead zone) of CH2.

By setting the adjustment sensitivity, repetitious turning ON/OFF of the output around the temperature set value (SV) can be prevented while two-position control is performed.

The value set to BFM #41/#60 is equally given to the upper portion and the lower portion of the temperature set value (BFM #12/#21). (For example, if the adjustment sensitivity value is set to "10%", 5% above the temperature set value and 5% below the temperature set value are treated as the dead zone (width of 10% in total).

The allowable set range is from 0.0 to 10.0%.

Example

Condition: When BFM #41/#60 is set to "10.0%" in the range span of 400 °C

$$400\text{ °C} \times 10.0\% / 100 = 40\text{ °C}$$

When the temperature set value is 200 °C, the range from 180 to 220 °C is treated as the dead zone.

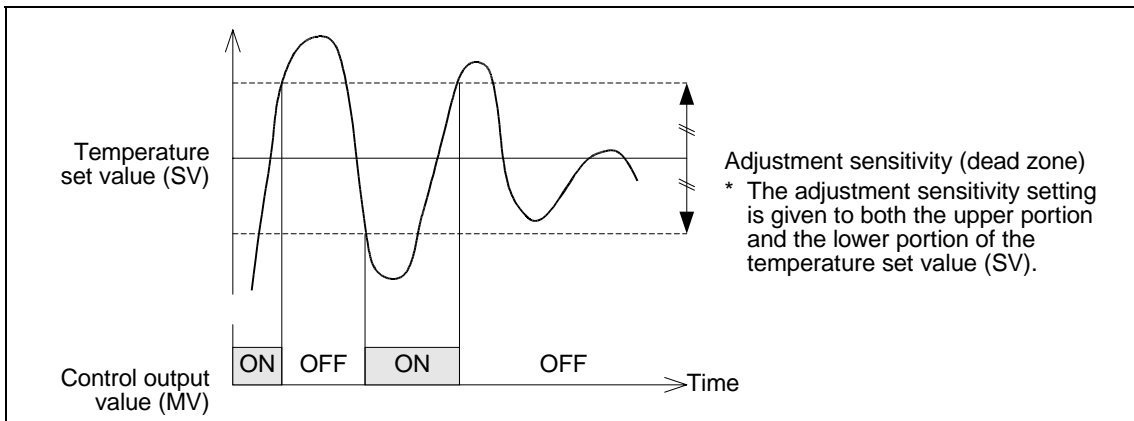

When the adjustment sensitivity (dead zone) is set to a large value, vertical fluctuation becomes large.

When the adjustment sensitivity is too small, small oscillations of the measured value cause chattering.

7.2.25 BFM #42 (CH1) and BFM #61 (CH2): Control output cycle setting

In BFM #42, set the control output cycle of CH1. In BFM #61, set the control output cycle of CH2.

Set the period of time in which the output turns ON and OFF.

The value set here multiplied by the control output value (%) is treated as the ON time. The value set here multiplied by "100 - Control output value (%)" is treated as the OFF time.

The allowable set range is from 1 to 100 sec.

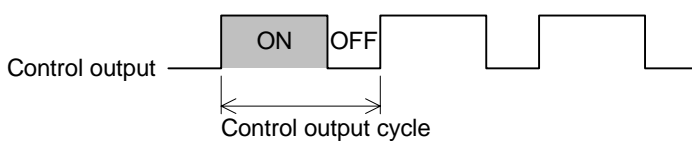

7.2.26 BFM #43 (CH1) and BFM #62 (CH2): Primary delay digital filter setting

In BFM #43, set the primary delay digital filter of CH1. In BFM #62, set the primary delay digital filter of CH2.

The FX2N-2LC is equipped with the software input filter so that fluctuation of the measured value (PV) caused by noise can be reduced. The time constant of this input filter can be set in accordance with the characteristics of the control target and the noise level.

If the time constant is too small, the input filter cannot give required effect. If the time constant is too large, the input responsibility is deteriorated.

The allowable set range is from 0 to 100 sec. When BFM #43/#62 is set to "0", the filter function is disabled.

While the filter function is disabled, data is acquired in the sampling cycle (500 ms).

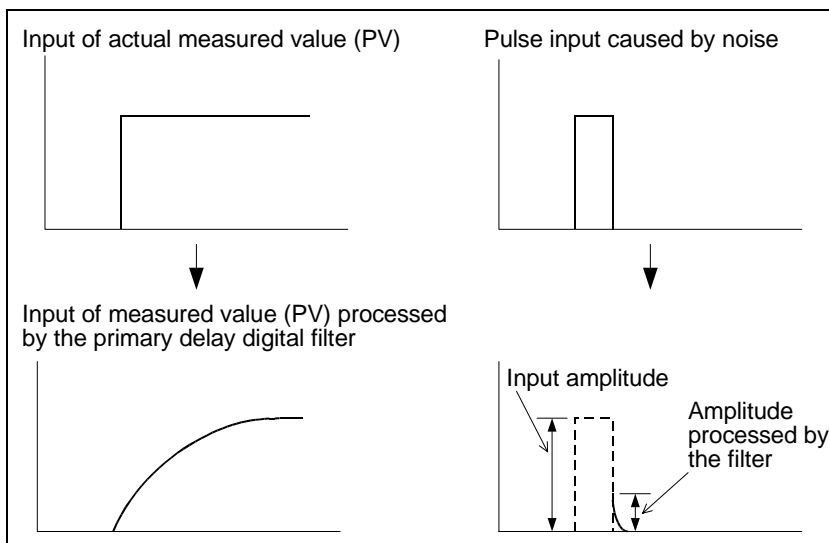

7.2.27 BFM #44 (CH1) and BFM #63 (CH2): Setting change ratio limiter

In BFM #44, set the setting change ratio limiter of CH1. In BFM #63, set the setting change ratio limiter of CH2.

The setting change ratio limiter function changes step by step the difference in the temperature set value when the temperature set value is changed.

Set the variation (%) per minute.

The allowable set range is from 0.1 to 100.0%.

When BFM #44/#63 is set to "0", the setting change ratio limiter function is disabled and the set value immediately changes.

Example

When the temperature set value 1 (SV1) is changed to the temperature set value 2 (SV2)

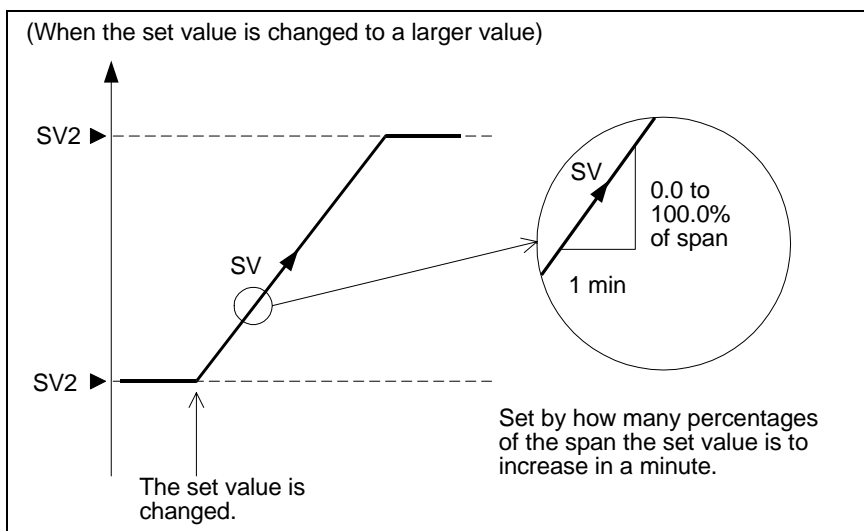

- When the power is turned ON, the PV changes to the SV step by step if the change ratio limiter function is used. (When the setting change ratio limiter function is used.)
- When the alarm function is used, the alarm wait function is not performed while the PV is changing to the SV step by step.

7.2.28 BFM #45 (CH1) and BFM #64 (CH2): AT (auto tuning) bias

In BFM #45, set the AT (auto tuning) bias of CH1. In BFM #64, set the AT (auto tuning) bias of CH2.

The allowable set range is \pm input range span ($^{\circ}\text{C} / ^{\circ}\text{F}$).

Set the AT bias for control targets in which the measured value (PV) should not exceed the temperature set value (SV) while auto tuning is performed.

The auto tuning function performs two-position control using the temperature set value (SV), hunts the measured value (PV), then calculates and sets each PID constant. However, for some control targets, overshoot caused by hunting is not desirable. Set the AT bias for such a case. When the AT bias is set, the set value (SV, AT point) with which auto tuning is performed can be changed.

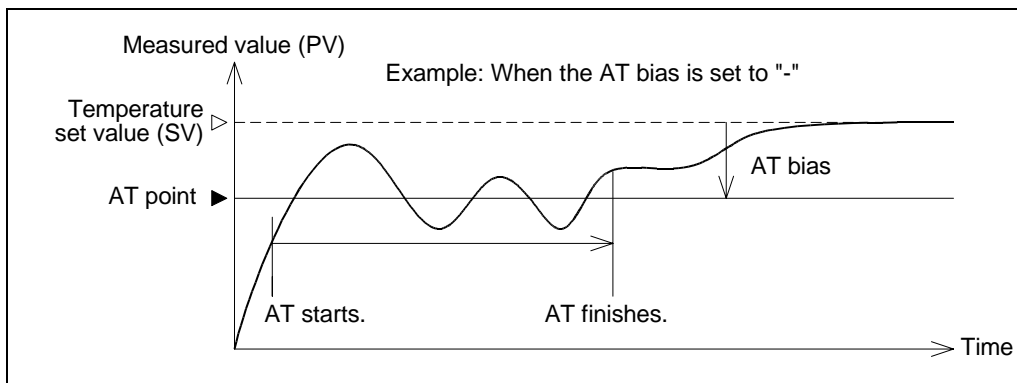

7.2.29 BFM #46 (CH1) and BFM #65 (CH2): Normal/reverse operation selection

In BFM #46, select the normal or reverse operation of CH1. In BFM #65, select the normal or reverse operation of CH2.

When BFM #46/#65 is set to "K0", normal operation is selected.

When BFM #46/#65 is set to "K1 (initial value)", reverse operation is selected.

Table 7.4:

Normal operation (0)	When actual temperature is higher than set value	To control cooling
Reverse operation (1)	When actual temperature is lower than set value	To control heating

The initial value is "reverse operation" (to control heating).

**7.2.30 BFM #47 (CH1) and BFM #66 (CH2): Setting the upper limit
BFM #48 (CH1) and BFM #67 (CH2): Setting the lower limit**

In BFM #47 and BFM #66, enter the upper range limit of CH1 and CH2 respectively. In BFM #48 and BFM #67, enter the lower range limit of CH1 and CH2 respectively.

Use these BFMs to set the upper and lower limits for the temperature set value (SV) (BFM #12, BFM #21). The default range is -100 to +1300 °C.

If the Set Value (SV) temperature is entered that is outside the input range, the "set range error" flag (BFM #0 b1) turns ON.

If an input range value (upper/lower) is entered that is not allowable, the "set range error" flag (BFM #0 b1) turns ON. (The same flag is used for both types of errors.)

When changing the input range values, make sure that the upper and lower limit values are inside the allowable input range.

The allowable set range for the lower limit is the higher of two values: the default value -100 °C or the lower limit for the sensor used (values shown on page 7-22). The allowable set range for the upper limit is the lower of two values: the default setting of +1300 °C or the upper limit for the sensor used (values shown on page 7-22). The initial value is the default input range (-100 to +1,300.)

7.2.31 BFM #49 (CH1) and BFM #68 (CH2): Loop breaking alarm judgement time

In BFM #49, set the loop breaking alarm judgement time of CH1. In BFM #68, set the loop breaking alarm judgement time of CH2.

The loop breaking alarm function starts to detect the variation of the measured value (PV) at every loop breaking alarm judgment time when the output becomes more than 100% (or the output limiter upper limit) or less than 0% (or the output limiter lower limit), then sets to ON the loop breaking alarm (CH1: BFM #1 b8, CH2: BFM #2 b8) when judging that there is an abnormality in the control loop.

The allowable set range is from 0 to 7,200 sec.

When BFM #49/#68 is set to "0", the loop breaking alarm function is disabled.

Abnormality judgment criteria

Table 7.5: Heating control (reverse operation)

When output is less than 0% or output limiter lower limit	When measured value (PV) does not decrease at least by loop breaking change criteria (2 °C) within loop breaking set time, an alarm is issued.
When output is more than 100% or output limiter upper limit	When measured value (PV) does not increase at least by loop breaking change criteria (2 °C) within loop breaking set time, an alarm is issued.

Table 7.6: Cooling control (normal operation)

When output is less than 0% or output limiter lower limit	When measured value (PV) does not decrease at least by loop breaking change criteria (2 °C) within loop breaking set time, an alarm is issued.
When output is more than 100% or output limiter upper limit	When measured value (PV) does not increase at least by loop breaking change criteria (2 °C) within loop breaking set time, an alarm is issued.

Abnormality targets

- 1) Abnormality in control target: Heater disconnection, lack of power supply, wiring mistake, etc.
- 2) Abnormality in sensor: Sensor disconnection, short-circuit, etc.
- 3) Abnormality in operating machine: Molten relay, wiring mistake, etc.
- 4) Abnormality in output circuit: Molten relay inside instrument, etc.
- 5) Abnormality in input circuit: No change in the measured value (PV) even after input has changed

The loop breaking alarm function judges abnormalities in the control loop, but cannot detect positions in which abnormalities occur.

Check each part of the control system in turn.

**7.2.32 In BFM #50, set the loop breaking alarm dead zone of CH1.
In BFM #69, set the loop breaking alarm dead zone of CH2.**

The loop breaking alarm function may issue alarms caused by disturbances (effect of another heat source, etc.) even if there is no abnormality in the control system. In order to prevent such alarms, by setting the loop breaking alarm dead zone, the region in which the alarm function is disabled (non-alarm status region) can be set.

For example, if the loop breaking alarm dead zone is set to "10 °C", 10 °C above the set value (SV) and 10°C below the set value (SV) are treated as the non-alarm status region (width of 20 °C in total).

While the measured value (PV) is located within the non-alarm region, alarm is not issued even if the alarm condition is satisfied.

The allowable set range is form 0.0 (or 0) to the input range span (°C or °F).

When BFM #50 / #69 is set to "0", the loop breaking alarm dead zone function is disabled.

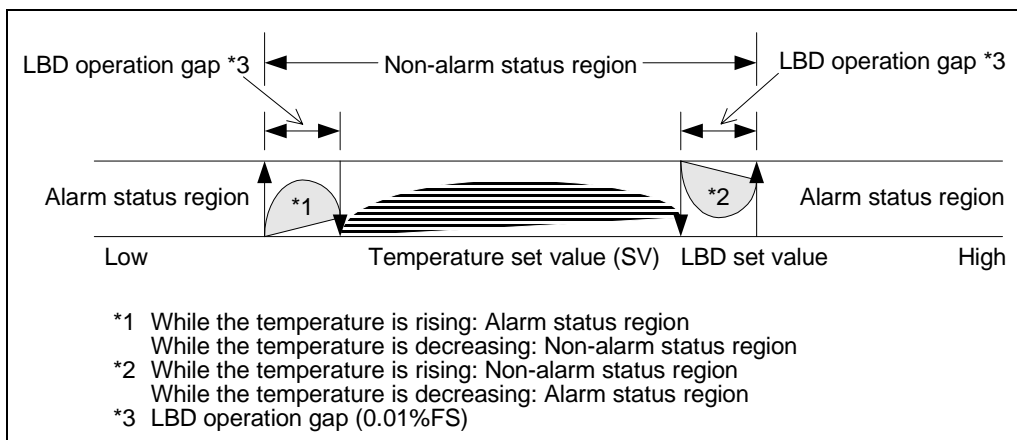

7.2.33 BFM #70 (CH1) and BFM #71 (CH2): Input type selection

In BFM #70, select the input type of CH1. In BFM #71, select the input type of CH2. The initial value is "2".

Table 7.7:

Set value	Sensor type	Input range	Unit
0	K	-200.0 to 200.0	10 ⁻¹ °C
1		-100.0 to 400.0	10 ⁻¹ °C
2		-100 to 1300	°C
3		-100 to 800	°F
4		-100 to 2400	°F
5	J	-200.0 to 200.0	10 ⁻¹ °C
6		-100.0 to 400.0	10 ⁻¹ °C
7		-100.0 to 800.0	10 ⁻¹ °C
8		-100 to 1200	°C
9		-100 to 1600	°F
10		-100 to 2100	°F
11	R	0 to 1700	°C
12		0 to 3200	°F
13	S	0 to 1700	°C
14		0 to 3200	°F
15	E	-200.0 to 200.0	10 ⁻¹ °C
16		0 to 1000	°C
17		0 to 1800	°F
18	T	-200.0 to 200.0	10 ⁻¹ °C
19		-200.0 to 400.0	10 ⁻¹ °C
20		0.0 to 400.0	10 ⁻¹ °C
21		-300.0 to 400.0	10 ⁻¹ °F
22		-300.0 to 700.0	10 ⁻¹ °F
23		0.0 to 700.0	10 ⁻¹ °F

Set value	Sensor type	Input range	Unit
24	B	0 to 1800	°C
25		0 to 3000	°F
26	N	0 to 1300	°C
27		0 to 2300	°F
28	PL II	0 to 1200	°C
29		0 to 2300	°F
30	WRe5-26	0 to 2300	°C
31		0 to 3000	°F
32	U	-200.0 to 600.0	10 ⁻¹ °C
33		-300.0 to 700.0	10 ⁻¹ °F
34	L	0.0 to 900.0	10 ⁻¹ °C
35		0 to 1600	°F
36	JPt100	-50.0 to 150.0	10 ⁻¹ °C
37		-200.0 to 500.0	10 ⁻¹ °C
38		-300.0 to 300.0	10 ⁻¹ °F
39		-300 to 900	°F
40	Pt100	-50.0 to 150.0	10 ⁻¹ °C
41		-200.0 to 600.0	10 ⁻¹ °C
42		-300.0 to 300.0	10 ⁻¹ °F
43		-300 to 1100	°F

*2 For B inputs, 0 to 399 °C (0 to 799 °F) is outside the precision compensation range.

*3 For PLII inputs, 0 to 32 °F is outside the precision compensation range.

*4 For WRe5 to WRe26 inputs, 0 to 32 °F is outside the precision compensation range.

7.2.34 BFM #72 to BFM #75: Alarm mode setting

The FX₂N-2LC is equipped with 14 types of alarms. Among them, up to 4 types can be used in accordance with the application.

Write the alarm No. used in Alarm 1 to BFM #72.

Write the alarm No. used in Alarm 2 to BFM #73.

Write the alarm No. used in Alarm 3 to BFM #74.

Write the alarm No. used in Alarm 4 to BFM #75.

The alarm modes set here are applied to both channels.

However, the set value of each alarm can be set for each channel, and the alarm result can be obtained for each channel also.

(CH1 set value: BFM #13 to BFM #16, CH2 set value: BFM #22 to BFM #25)

CH1 alarm result: BFM #1 b4 to b8, CH2 alarm result: BFM #2 b4 to b8)

Or a same alarm type can be set to two or more BFM Nos.

The initial value is "0 (alarm function OFF)". For the details, refer to Section 6.

Table 7.8:

Alarm No.	Alarm type	Description	Set range
0	Alarm function OFF	Alarm function is disabled.	---
1	Upper limit input value alarm	When measured value (PV) is more than alarm set value, an alarm is issued.	Input range
2	Lower limit input value alarm	When measured value (PV) is less than alarm set value, an alarm is issued.	Input range
3	Upper limit deviation alarm	When deviation (= Measured value (PV) - Set value (SV)) is more than alarm set value, an alarm is issued.	±Input width
4	Lower limit deviation alarm	When deviation (= Measured value (PV) - Set value (SV)) is less than alarm set value, an alarm is issued.	±Input width
5	Upper/lower limit deviation	When absolute deviation (= Measured value (PV) - Set value (SV)) is more than alarm set value, an alarm is issued.	+Input width
6	Range alarm	When absolute deviation (= Measured value (PV) - Set value (SV)) is less than alarm set value, an alarm is issued.	+Input width
7	Upper limit input value alarm with wait	When measured value (PV) is more than alarm set value, an alarm is issued. However, when power is turned ON, measured value is ignored.	Input range
8	Lower limit input value alarm with wait	When measured value (PV) is less than alarm set value, an alarm is issued. However, when power is turned ON, measured value is ignored.	Input range
9	Upper limit deviation value alarm with wait	When deviation (= Measured value (PV) - Set value (SV)) is more than alarm set value, an alarm is issued. However, when power is turned ON, measured value is ignored.	±Input width
10	Lower limit deviation value alarm with wait	When deviation (= Measured value (PV) - Set value (SV)) is less than alarm set value, an alarm is issued. However, when power is turned ON, measured value ignored.	±Input width

Table 7.8:

Alarm No.	Alarm type	Description	Set range
11	Upper/lower limit deviation value alarm with wait	When absolute deviation ($= \text{Measured value (PV)} - \text{Set value (SV)} $) is more than alarm set value, an alarm is issued. However, when power is turned ON, measured value is ignored.	+Input width
12	Upper limit deviation value alarm with re-wait	When deviation ($= \text{Measured value (PV)} - \text{Set value (SV)}$) is more than alarm set value, an alarm is issued. However, when power is turned ON and when set value is changed, measured value is ignored.	\pm Input width
13	Lower limit deviation value alarm with re-wait	When deviation ($= \text{Measured value (PV)} - \text{Set value (SV)}$) is less than alarm set value, an alarm is issued. However, when power is turned ON and when set value is changed, measured value is ignored.	\pm Input width
14	Upper/lower limit deviation value alarm with re-wait	When absolute deviation ($= \text{Measured value (PV)} - \text{Set value (SV)} $) is more than alarm set value, an alarm is issued. However, when power is turned ON and when set value is changed, measured value is ignored.	+Input width

Input range : Numeric value from the lower limit to the upper limit of input value

Input width : Width from the lower limit to the upper limit of input value (Input width = Upper limit value - Lower limit value)

\pm Input width: Both a positive and negative numeric values can be set.

+ Input width: Only a positive numeric value can be set.

7.2.35 BFM #76: Alarm 1/2/3/4 dead zone setting

In BFM #76, set the dead zone of alarms 1 to 4. This setting is applied to all of alarms 1 to 4. When the measured value (PV) is near the alarm set value, the alarm status and the non-alarm status may be repeated by fluctuation in inputs. In order to cope with such a case, by setting the alarm dead zone, repeating of the alarm status and the non-alarm status can be prevented.

The allowable set range is the input range (from 0.0 to 10.0%.)

Upper limit input value alarm and upper limit deviation alarm

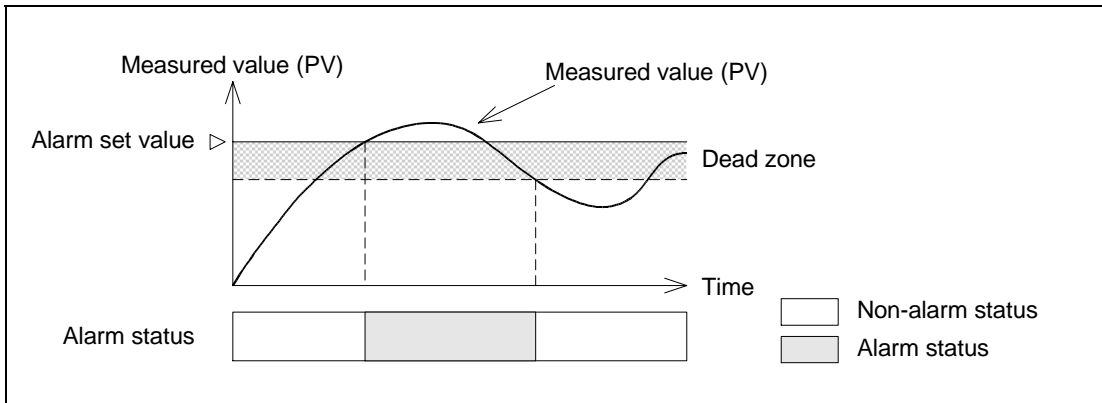

Lower limit input value alarm and lower limit deviation alarm

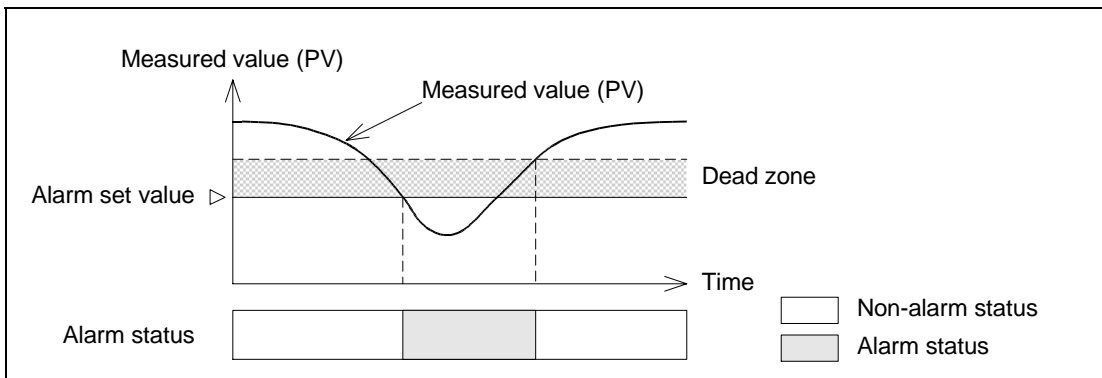

Upper/lower limit deviation alarm

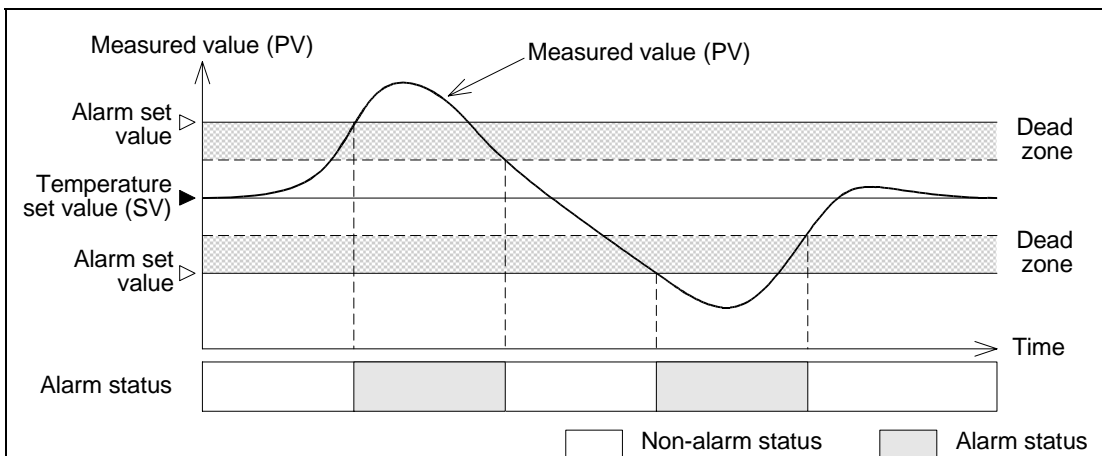

7

7.2.36 BFM #77: Number of times of alarm 1/2/3/4 delay

In BFM #77, set the number of alarm delays. This setting is applied to all alarms 1 to 4. The alarm delay function keeps the non-alarm status until the number of input samples exceeds the number of alarm delays, after the deviation between the measured value (PV) and the set value (SV) reaches the alarm set value. If the deviation remains in the alarm range until the number of input samples exceeds the number of alarm delays, an alarm is issued. The allowable set range is from 0 to 255 times. (input sampling cycle: 500 ms)

Example: When the number of alarm delays, is set to 5 times

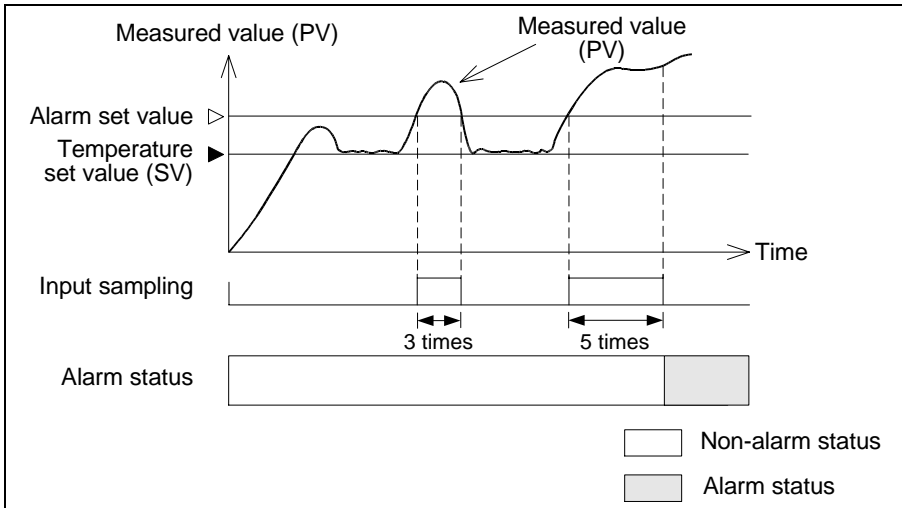

7.2.37 BFM #78: Number of times of heater disconnection alarm delay

In BFM #78, set the number of heater disconnection alarm delays. This setting is applied to both CH1 and CH2. If the abnormal status consecutively occurs in the heater current measured value (sampling cycle: 1 sec) by the preset number of times, an alarm is issued. The allowable set range is from 3 to 255 times.

7.2.38 BFM #79: Temperature rise completion range setting

In BFM #79, set the temperature rise completion range. This setting is applied to both CH1 and CH2. Set the temperature range in which the temperature rise completion range is judged based on the temperature set value. The actual temperature rise completion range is judged within the range above and below the temperature set value, so the range width is twice. Set integers from 1 to 10 for temperature (° C). (The setting value does not depend on BFM #70 and #71 input type selection.)

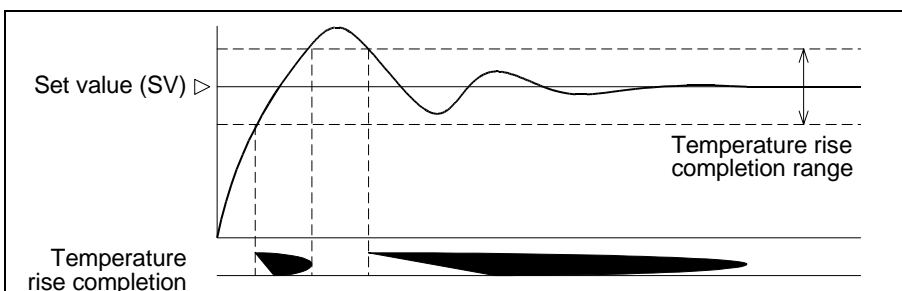

7.2.39 BFM #80: Temperature rise completion soak time

In BFM #80, set the temperature rise completion soak time. This setting is applied to both CH1 and CH2.

The temperature rise completion soak time is the period of time after the measured value reaches the temperature rise completion range until the temperature rise completion flag turns ON.

In order to cope with a case in which the measured value has reached the temperature rise completion range but is not stable yet, by setting the soak time, the wait time can be set for judgement on temperature rise completion.

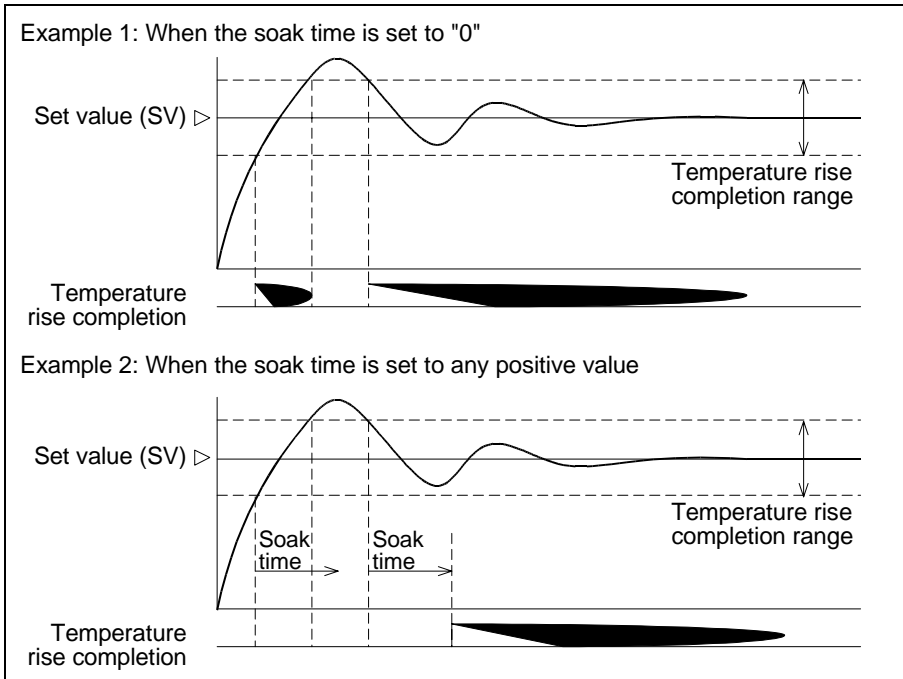

7.2.40 BFM #81: CT monitor method changeover

In BFM #81, change over the CT monitor method. This setting is applied to both CH1 and CH2. The current is detected by sampling performed every second.

While the temperature is controlled, the control output repeatedly turns ON and OFF. Accordingly, the current in the ON time (= ON current) and the current in the OFF time (= OFF current) are alternately displayed. If the output cycle is short, the displayed value is not stable and is difficult to read.

To cope with this, the display (monitor) method can be selected.

When BFM #81 is set to "K0 (initial value)", the ON current and the OFF current are alternately displayed.

When BFM #81 is set to "K1", only the ON current is displayed. Even in the OFF time, the ON current remains displayed.

When control is stopped, the OFF current is displayed without regard to the setting of BFM #81.

7.2.41 BFM #82: Set value range error address

When an out-of-range error occurs in the set value written to each BFM, BFM #82 indicates the BFM No. in which the error occurs.

While no error occurs, BFM #82 stores "0".

When an error occurs, BFM #82 stores the BFM No. in which the error occurs. Check the set range, set a proper value for the corresponding BFM, then reset the error (BFM #10).

7.2.42 BFM #83: Set value backup command

BFM #83 writes the values set to BFM #12 to BFM #29 and BFM #32 to BFM #81 to the EEPROM built in the FX_{2N}-2LC.

When the power is turned ON, the FX_{2N}-2LC transfers the data stored in the EEPROM to the buffer memories and use the data as the set values for temperature control. When the set values are backed up (written to the EEPROM) once, BFM #12 to BFM #29 and BFM #32 to BFM #81 do not have to be set at the next time and later. As a result, as soon as control starts (BFM #11), temperature control is enabled.

(At the time of shipment, the EEPROM stores the initial values.)

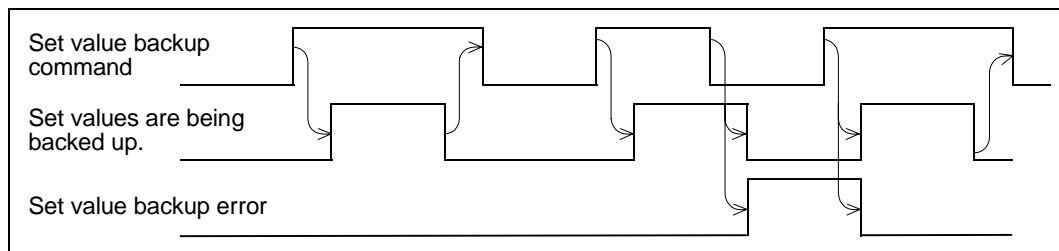

Description on operation

- 1) When the set value backup command turns on, the FX_{2N}-2LC turns on the set value backup flag.
- 2) When backup of the set values is completed, the set value backup flag turns off. When this flag turns off, turn off the set value backup command.
- 3) If the set value backup command turns off while the set values are being backed up, the set value backup error turns on. In such a case, normally back up the set values again. If the power is turned off and on while a backup error is present, each data is reset to the initial value.
- 4) While a set value range error (BFM #0 b1) is present, the set values are not backed up.

1	Introduction
2	Product Configuration
3	Specifications
4	Wiring
5	Introduction of Functions
6	Alarm
7	Buffer Memory (BFM)
8	Program Example
9	Diagnostic

8. Program Example



Cautions on Startup

- Never touch any terminal while the power is supplied.
If you touch a terminal while the power is supplied, you may get electrical shock or the unit may malfunction.
- Turn OFF the power before cleaning the unit or tightening the terminals.
If you clean the unit or tighten the terminals while the power is supplied, you may get electrical shock.
- Thoroughly read the manual, sufficiently assure safety, then perform temperature control.
An operation mistake may cause damages in the machine or accidents.



- Never disassemble or modify the unit. Disassembly or modification may cause failure, malfunction or fire.
* For repair, contact Mitsubishi Electric System Service.
- Turn OFF the power before connecting or disconnecting a connection cable such as extension cable.
If you connect or disconnect a connection cable while the power is supplied, failure or malfunction may be caused.

8.1 Program example

This paragraph introduces an example of program to operate the FX_{2N}-2LC.

Condition

Input range	: Model K -- 100.0 to 400.0 °C
PID values	: Set by auto tuning
Alarm	: Upper limit deviation alarm with re-wait and lower limit deviation alarm with re-wait
Alarm dead zone	: 1% (initial value)
Control response	: Medium
Operation mode	: Monitor + Temperature alarm + Control (initial value)
Control output cycle	: 30 sec (initial value)
Normal/reverse operation	: Reverse operation (initial value)
Loop breaking alarm judgement time	: 480 sec (initial value)
Temperature rise completion range	: 3 °C
CT monitor method	: ON current/OFF current (initial value)

The control output cycle, output limiter, output change ratio limiter, loop breaking alarm judgement time, alarm dead zone, heater disconnection alarm, sensor correction value, adjustment sensitivity (dead zone), primary delay digital filter, setting change ratio limiter, auto tuning bias, setting limiter and the temperature rise completion soak time are not set. (The initial values are used.)

Device assignment

Inputs

- X000: Performs initialization when the power is turned ON from OFF.
- X001: Resets errors when the power is turned ON from OFF.
- X002: Control start (ON)/stop (OFF)
- X003: Performs auto tuning when the power is turned ON from OFF (CH1).
- X004: Performs auto tuning when the power is turned ON from OFF (CH2).
- X005: Writes the EEPROM when the power is turned ON from OFF.

Auxiliary relays

- M0 to M15: Flags
- M20 to M35: Events (CH1)
- M40 to M55: Events (CH2)

Data registers

D0 , D1:Set values

D2: Not used

D3: Temperature measured value (PV) of CH1

D4: Temperature measured value (PV) of CH2

D5: Control output value (MV) of CH1

D6: Control output value (MV) of CH2

D7: Heater current measured value of CH1

D8: Heater current measured value of CH2

D82: Set value range error address

PLC program

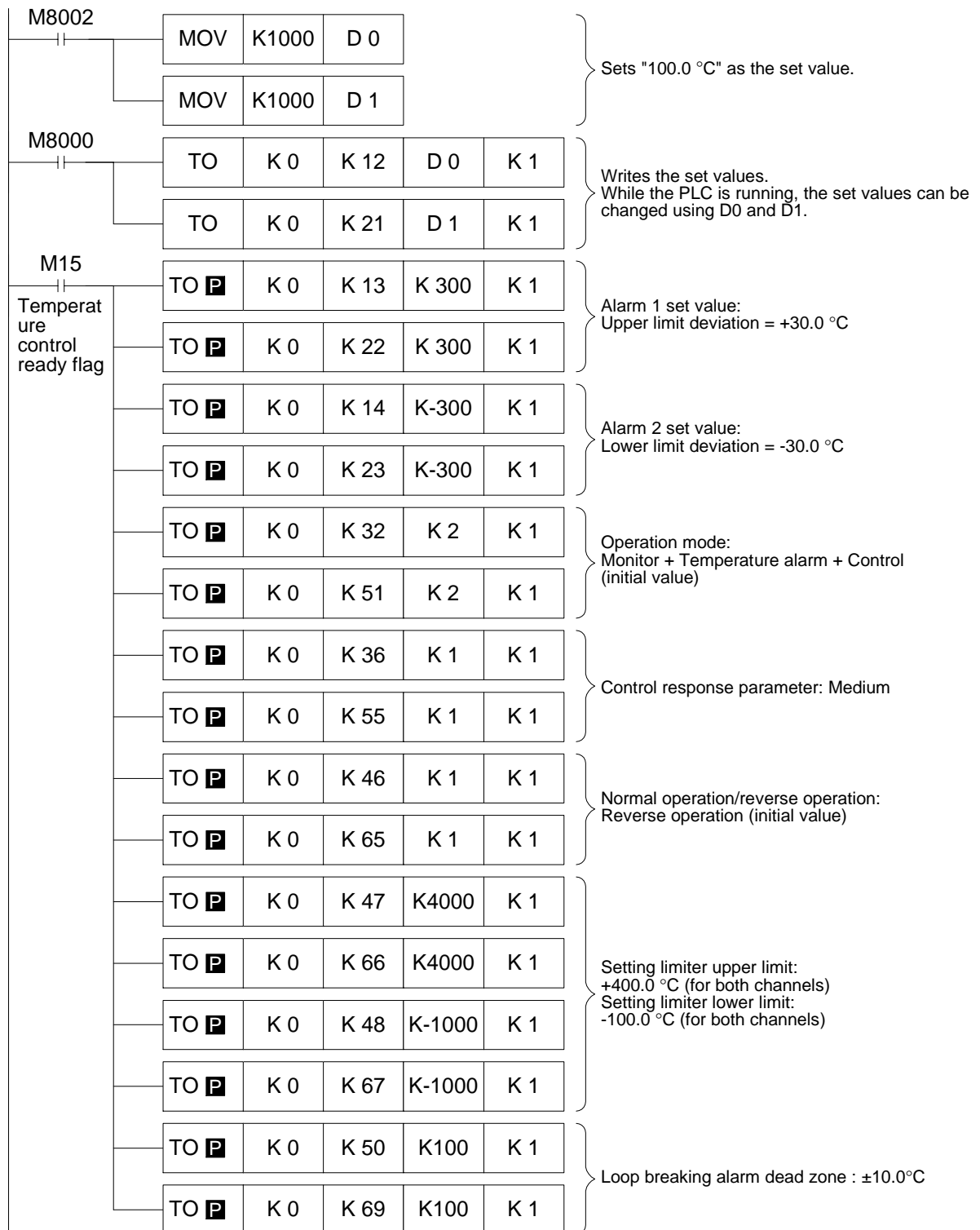

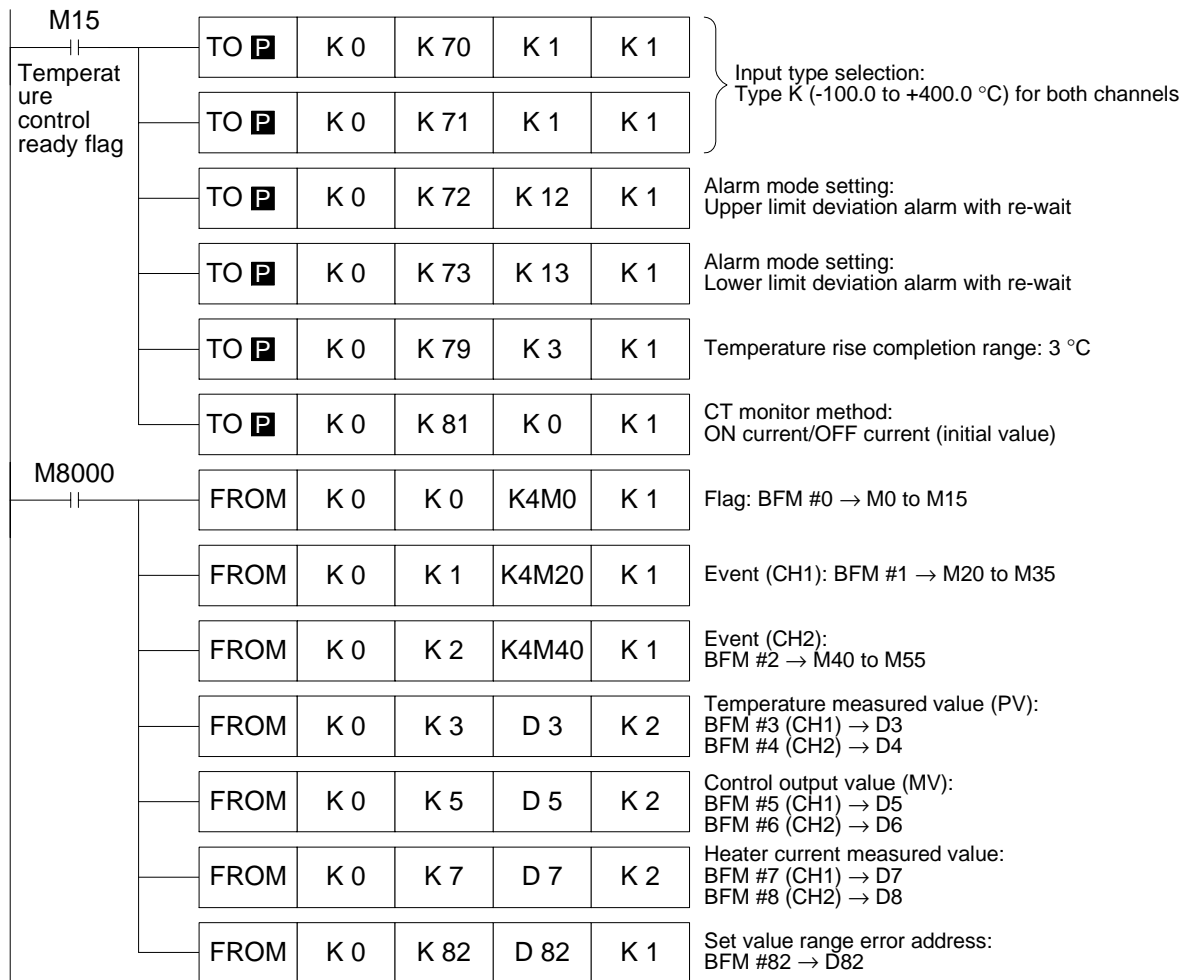

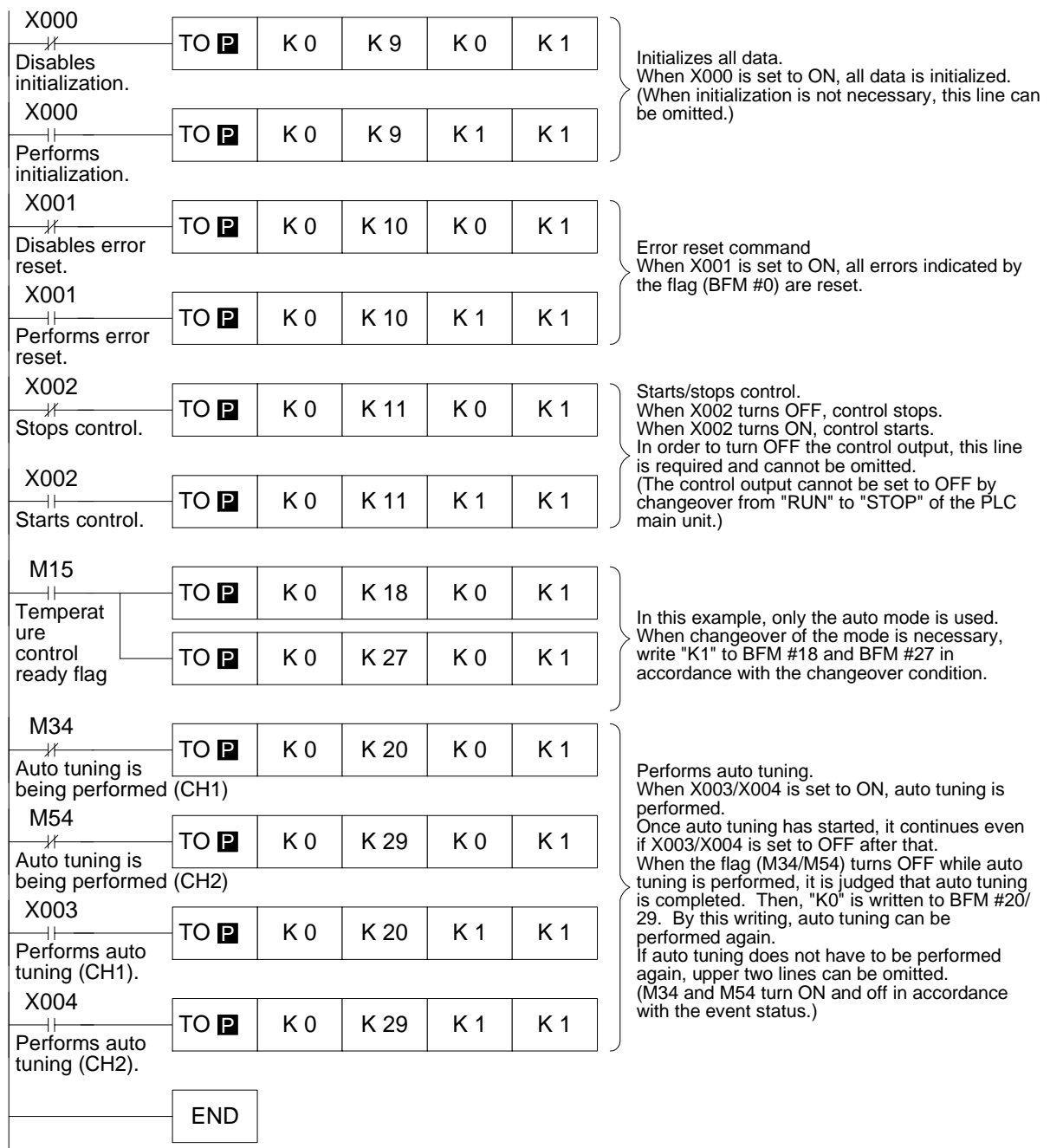

- In a practical program, if the setting has been determined by initialization or backup to the EEPROM, it is not required to write such setting again.

- In this example, the status of the flags (BFM #0) and the events (BFM #1 and BFM #2) can be monitored using auxiliary relays (M). In order to output such status to the outside, use each auxiliary relay as a contact and drive outputs (Y).

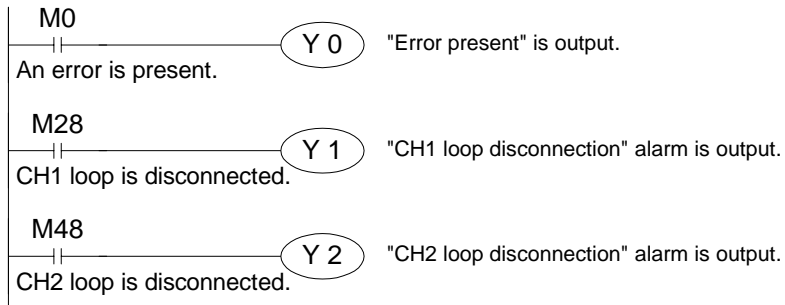

MEMO

1	Introduction
2	Product Configuration
3	Specifications
4	Wiring
5	Introduction of Functions
6	Alarm
7	Buffer Memory (BFM)
8	Program Example
9	Diagnostic

9. Diagnostic

By reading the flags (BFM #0) and the events (BFM #1 and BFM #2) using FROM instructions, you can confirm errors (such as lack of the driving power supply 24 V, heater disconnection and loop breaking) which can be recognized by the FX2N-2LC.

Table 9.1: Flags (BFM #0) indicating errors

Bit No.	Description	Operation
b0	Error present	Turns ON when an error among b1 to b10 below has occurred.
b1	Set value range error	Turns ON when data outside set range is written.
b2	24 VDC power supply error	Turns ON when driving power supply (24 VDC) is not supplied.
b3	Set value backup error	Turns ON when an error has been caused by noise or when a failure has occurred in FX2N-2LC. If contents of error are not eliminated even after power is turned OFF once then ON again, contact Mitsubishi Electric System Service.
⋮	⋮	⋮
b8	Sum check error for adjustment data error	Turns ON when an error has been caused by noise or when a failure has occurred in FX2N-2LC.
b9	Cold contact temperature compensation data error	If contents of error are not eliminated even after power is turned OFF once then ON again, contact Mitsubishi Electric System Service.
b10	A/D converted value error	

Events (BFM #1 and BFM #2) indicating errors

Table 9.2: Events (BFM #1 and BFM #2) indicating errors

Bit No.	Assignment	Description
b0	Input error (upper limit)	Turns ON when input value is over scale.
b1	Input error (lower limit)	Turns ON when input value is under scale.
b2	Cold contact temperature compensation data error	Turns ON when an error has been caused by noise or when a failure has occurred in FX2N-2LC.
b3	A/D converted value error	If contents of error are not eliminated even after power is turned OFF once then ON again, contact Mitsubishi Electric System Service.
b4	Alarm 1	Turns ON when an alarm has occurred.
b5	Alarm 2	Turns ON when an alarm has occurred.
b6	Alarm 3	Turns ON when an alarm has occurred.
b7	Alarm 4	Turns ON when an alarm has occurred.
b8	Loop breaking alarm	Turns ON when a loop breaking alarm has occurred.
b9	Heater disconnection alarm	Turns ON when a heater disconnection alarm has occurred.
b10	Heater meltdown alarm	Turns ON when a heater meltdown alarm has occurred.

When an error above has occurred, the contents described in the corresponding "Description" column may be causes.

Eliminate causes of errors, then reset all errors using BFM #10.

If causes of an error remain, the corresponding bit turns ON again.

Other causes of errors

In addition to the flags and the events, the following situation may be realized.

- 1) The FX_{2N}-2LC does not operate with the set values written by TO instructions.
 - Check whether or not the FX_{2N}-2LC is correctly connected to the PLC.
(Check the connector positions and the connection status.)
 - Check whether or not the unit No. and the BFM Nos. are correctly specified in FROM/TO instructions.
- 2) The POWER LED is not lit.
 - Check whether or not the FX_{2N}-2LC is correctly connected to the PLC.
(Check the connector positions and the connection status.)
 - Check whether or not the used capacity of the service power supply of the PLC main unit exceeds the allowable range.

HEADQUARTERS	
MITSUBISHI ELECTRIC EUROPE B.V. German Branch Gothaer Straße 8 D-40880 Ratingen Phone: +49 (0)2102 / 486-0 Fax: +49 (0)2102 / 486-1120	EUROPE
MITSUBISHI ELECTRIC EUROPE B.V. French Branch 25, Boulevard des Bouvets F-92741 Nanterre Cedex Phone: +33 (0)1 / 55 68 55 68 Fax: +33 (0)1 / 55 68 57 57	FRANCE
MITSUBISHI ELECTRIC EUROPE B.V. Irish Branch Westgate Business Park, Ballymount IRL-Dublin 24 Phone: +353 (0)1 4198800 Fax: +353 (0)1 4198890	IRELAND
MITSUBISHI ELECTRIC EUROPE B.V. Italian Branch Viale Colleoni 7 I-20041 Agrate Brianza (MI) Phone: +39 039 / 60 53 1 Fax: +39 039 / 60 53 12	ITALY
MITSUBISHI ELECTRIC CORPORATION Office Tower "Z" 14 F 8-12, 1 chome, Harumi Chuo-Ku Tokyo 104-6212 Phone: +81 3 622 160 60 Fax: +81 3 622 160 75	JAPAN
MITSUBISHI ELECTRIC EUROPE B.V. UK Branch Travellers Lane UK-Hatfield, Herts. AL10 8XB Phone: +44 (0)1707 / 27 61 00 Fax: +44 (0)1707 / 27 86 95	UK
MITSUBISHI ELECTRIC EUROPE B.V. Spanish Branch Carretera de Rubí 76-80 E-08190 Sant Cugat del Vallés (Barcelona) Phone: +34 93 / 565 3131 Fax: +34 93 / 589 1579	SPAIN
MITSUBISHI ELECTRIC AUTOMATION 500 Corporate Woods Parkway Vernon Hills, IL 60061 Phone: +1 847 478 21 00 Fax: +1 847 478 22 83	USA

EUROPEAN REPRESENTATIVES	
GEVA Wiener Straße 89 AT-2500 Baden Phone: +43 (0)2252 / 85 55 20 Fax: +43 (0)2252 / 488 60	AUSTRIA
TEHNIKON Oktyabrskaya 16/5, Off. 703-711 BY-220030 Minsk Phone: +375 (0)17 / 210 46 26 Fax: +375 (0)17 / 210 46 26	BELARUS
Koning & Hartman B.V. Industrial Solutions Woluwelaan 31 BE-1800 Vilvoorde Phone: +32 (0)2 / 257 02 40 Fax: +32 (0)2 / 257 02 49	BELGIUM
AKHNATON 4 Andrej Ljapchev Blvd. Pb 21 BG-1756 Sofia Phone: +359 (0)2 / 97 44 05 8 Fax: +359 (0)2 / 97 44 06 1	BULGARIA
INEA CR d.o.o. Losinjska 4 a HR-10000 Zagreb Phone: +385 (0)1 / 36 940 -01/-02/-03 Fax: +385 (0)1 / 36 940 -03	CROATIA
AutoCont Control Systems, s.r.o. Jelinkova 59/3 CZ-721 00 Ostrava Svinov Phone: +420 (0)59 / 5691 150 Fax: +420 (0)59 / 5691 199	CZECH REPUBLIC
AutoCont Control Systems, s.r.o. Technologická 374/6 CZ-708 00 Ostrava-Pustkovec Phone: +420 595 691 150 Fax: +420 595 691 199	CZECH REPUBLIC
B:TECH, a.s. Na Ostrove 84 CZ-58001 Havlickuv Brod Phone: +420 (0)569 / 408 841 Fax: +420 (0)569 / 408 889	CZECH REPUBLIC
B:TECH, a.s. Headoffice U Borové 69 CZ-580 01 Havlickuv Brod Phone: +420 569 777 777 Fax: +420 569 777 778	CZECH REPUBLIC
Beijer Electronics A/S Lautrupvej 1-3 DK-2750 Ballerup Phone: +45 (0)70 / 26 46 46 Fax: +45 (0)70 / 26 48 48	DENMARK
Beijer Electronics Eesti OÜ Pärnu mnt.160i EE-11317 Tallinn Phone: +372 (0)6 / 51 81 40 Fax: +372 (0)6 / 51 81 49	ESTONIA
Beijer Electronics OY Jaakonkatu 2 FIN-01620 Vantaa Phone: +358 (0)207 / 463 500 Fax: +358 (0)207 / 463 501	FINLAND
UTECO A.B.E.E. 5, Mavrogenous Str. GR-18542 Piraeus Phone: +30 211 / 1206 900 Fax: +30 211 / 1206 999	GREECE
Meltrade Ltd. Fertő utca 14. HU-1107 Budapest Phone: +36 (0)1 / 431-9726 Fax: +36 (0)1 / 431-9727	HUNGARY
Beijer Electronics SIA Vestienas iela 2 LV-1035 Riga Phone: +371 (0)784 / 2280 Fax: +371 (0)784 / 2281	LATVIA

EUROPEAN REPRESENTATIVES	
Beijer Electronics UAB Savanoriu Pr. 187 LT-02300 Vilnius Phone: +370 (0)5 / 232 3101 Fax: +370 (0)5 / 232 2980	LITHUANIA
INTEHSIS srl bld. Traian 23/1 MD-2060 Kishinev Phone: +373 (0)22 / 66 4242 Fax: +373 (0)22 / 66 4280	MOLDOVA
Koning & Hartman B.V. Haarlerbergweg 21-23 NL-1101 CH Amsterdam Phone: +31 (0)20 / 587 76 00 Fax: +31 (0)20 / 587 76 05	NETHERLANDS
Beijer Electronics AS Postboks 487 NO-3002 Drammen Phone: +47 (0)32 / 24 30 00 Fax: +47 (0)32 / 84 85 77	NORWAY
MPL Technology Sp. z o.o. Ul. Krakowska 50 PL-32-083 Balice Phone: +48 (0)12 / 630 47 00 Fax: +48 (0)12 / 630 47 01	POLAND
Sirius Trading & Services srl Aleea Lacul Morii Nr. 3 RO-060841 Bucuresti, Sector 6 Phone: +40 (0)21 / 430 40 06 Fax: +40 (0)21 / 430 40 02	ROMANIA
CRAFT Consulting & Engineering d.o.o. Bulevar Svetog Cara Konstantina 80-86 SER-18106 Nis Phone: +381 (0)18 / 292-24-4/5, 523 962 Fax: +381 (0)18 / 292-24-4/5, 523 962	SERBIA
INEA SR d.o.o. Karadjordjeva 12/260 SER-113000 Smederevo Phone: +381 (0)26 / 617 163 Fax: +381 (0)26 / 617 163	SERBIA
CS MTrade Slovensko, s.r.o. Vajanskeho 58 SK-92101 Piestany Phone: +421 (0)33 / 7742 760 Fax: +421 (0)33 / 7735 144	SLOVAKIA
INEA d.o.o. Stegne 11 SI-1000 Ljubljana Phone: +386 (0)1 / 513 8100 Fax: +386 (0)1 / 513 8170	SLOVENIA
Beijer Electronics Automation AB Box 426 SE-20124 Malmö Phone: +46 (0)40 / 35 86 00 Fax: +46 (0)40 / 35 86 02	SWEDEN
ECONOTEC AG Hinterdorfstr. 12 CH-8309 Nürensdorf Phone: +41 (0)44 / 838 48 11 Fax: +41 (0)44 / 838 48 12	SWITZERLAND
GTS Darulaceze Cad. No. 43 KAT. 2 TR-34384 Okmeydani-Istanbul Phone: +90 (0)212 / 320 1640 Fax: +90 (0)212 / 320 1649	TURKEY
CSC Automation Ltd. 15, M. Raskova St., Fl. 10, Office 1010 UA-02002 Kiev Phone: +380 (0)44 / 494 33 55 Fax: +380 (0)44 / 494-33-66	UKRAINE

EURASIAN REPRESENTATIVES	
Kazpromautomatics Ltd. 2, Scladskaya str. KAZ-470046 Karaganda Phone: +7 3212 / 50 11 50 Fax: +7 3212 / 50 11 50	KAZAKHSTAN
ELEKTROSTILY Rubzovskaja nab. 4-3, No. 8 RU-105082 Moscow Phone: +7 495 / 545 3419 Fax: +7 495 / 545 3419	RUSSIA
ICOS Industrial Computer Systems ZAO Ryazanskij Prospekt, 8A, Office 100 RU-109428 Moscow Phone: +7 495 / 232 0207 Fax: +7 495 / 232 0327	RUSSIA
NPP "URALEKTRA" Sverdlova 11A RU-620027 Ekaterinburg Phone: +7 343 / 353 2745 Fax: +7 343 / 353 2461	RUSSIA

MIDDLE EAST REPRESENTATIVES	
Ilan & Gavish Ltd. Automation Service 24 Shenkar St., Kiryat Arie IL-49001 Petah-Tiqva Phone: +972 (0)3 / 922 18 24 Fax: +972 (0)3 / 924 0761	ISRAEL
Texel Electronics Ltd. 2 Ha'umanut, P.O.B. 6272 IL-42160 Netanya Phone: +972 (0)9 / 863 08 91 Fax: +972 (0)9 / 885 24 30	ISRAEL

AFRICAN REPRESENTATIVE	
CBI Ltd. Private Bag 2016 ZA-1600 Isando Phone: +27 (0)11 / 928 2000 Fax: +27 (0)11 / 392 2354	SOUTH AFRICA