

# FX<sub>1N</sub>

## FX<sub>1N</sub>-2AD-BD Analog Input Expansion Board

### User's Manual

JY992D96201B

This manual contains text, diagrams and explanations which will guide the reader in the correct installation, safe use and operation of the FX<sub>1N</sub>-2AD-BD Analog Input Expansion Board and should be read and understood before attempting to install or use the unit. Further information can be found in the associated manuals list below.

Specifications are subject to change without notice

### Guidelines for the Safety of the User and Protection of the FX<sub>1N</sub>-2AD-BD Analog Input Expansion Board.

This manual has been written to be used by trained and competent personnel. The definition of such a person or persons is as follows:

- a) Any engineer using the product associated with this manual, should be of a competent nature, trained and qualified to the local and national standards. These engineers should be fully aware of all aspects of safety with regards to automated equipment.
- b) Any commissioning or service engineer must be of a competent nature, trained and qualified to the local and national standards.
- c) All operators of the completed equipment should be trained to use that product in a safe and coordinated manner in compliance to established safety practices.

**Note:** The term 'completed equipment' refers to a third party constructed device which contains or uses the product associated with this manual.

#### Note's on the Symbols Used in this Manual

At various times through out this manual certain symbols will be used to highlight points of information which are intended to ensure the users personal safety and protect the integrity of equipment.



- 1) Indicates that the identified danger **WILL** cause physical and property damage.



- 2) Indicates that the identified danger could **POSSIBLY** cause physical and property damage.

- Under no circumstances will Mitsubishi Electric be liable or responsible for any consequential damage that may arise as a result of the installation or use of this equipment.
- All examples and diagrams shown in this manual are intended only as an aid to understanding the text, not to guarantee operation. Mitsubishi Electric will accept no responsibility for actual use of the product based on these illustrative examples.
- Owing to the very great variety in possible application of this equipment, you must satisfy yourself as to its suitability for your specific application.

### Associated Manual

	Manual Name	Manual Number	Description
	FX1S Series Programmable controllers Hardware Manual	JY992D83901	Describes contents related to hardware of the FX1S series PLC, such as specifications, wiring and installation.
	FX1N Series Programmable controllers Hardware Manual	JY992D89301	Describes contents related to hardware of the FX1N series PLC, such as specifications, wiring and installation.
⊙	FX Series of Programmable controllers Programming Manual II	JY992D88101	Describes instructions in FX1S/FX1N/FX2N/FX2NC series.

⊙ Indispensable manual

# 1. Introduction

The FX1N-2AD-BD analog input expansion board (hereafter called "2AD" or "expansion board") is to be installed in an FX1S or FX1N series PLC, to increase the analog input by 2 points.

## 1.1 Features of 2AD

- 1) Analog input of two points can be increased using 2AD. If a 2AD is used, internal mounting in the top of the PLC means that there is no need for a change to the installation area of the PLC.
- 2) Voltage input (0 ~10V) or current input (4 ~ 20mA) for analog to digital conversion can be set by switching the auxiliary relays assigned to each channel.  
Moreover, a digital value after conversion of each channel is stored in special data register allocated to each channel, as shown in the table below.  
However, the analog to digital conversion characteristic cannot be adjusted.

**Table 1.1: Allocated Device**

Device	Description
M8112	Switch of input mode of Ch1 flag OFF: Voltage input mode (0 ~ 10V) ON: Current input mode (4 ~ 20mA)
M8113	Switch of input mode of Ch2 flag OFF: Voltage input mode (0 ~ 10V) ON: Current input mode (4 ~ 20mA)
D8112	Digital value of Ch1
D8113	Digital value of Ch2

## 1.2 External Dimensions and Each Part Name

Dimensions: mm (inches)    Accessory: Top cover for board ×1,  
M3 self-tapping screw ×3 (to fix top cover ×1, to mount board ×2)

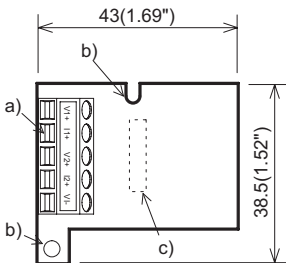

- a) Terminals to connect analog module  
The top face of this terminal block is higher than the top face of the panel cover of the programmable controller by approximately 7mm (0.28").

**Table 1.2: Allocation Terminal**

Terminal name	Content
V1+	Voltage input terminal for channel 1(Ch1)
I1+	Current input terminal for channel 1(Ch1)
V2+	Voltage input terminal for channel 2(Ch2)
I2+	Current input terminal for channel 2(Ch2)
VI-	Common terminal for each channel

- b) Mounting holes (2- Ø4.0 / 0.16")  
c) Connector for PLC

## 1.3 System Configuration

- Only one expansion board can be used on one FX1S and FX1N PLC main unit.  
Do not try to install two or more expansion boards. (They will not function)
- The 2AD cannot be used with a FX1N-EEPROM-8L or FX1N-5DM.

## 1.4 Applicable PLC

**Table 1.3: Applicable Programmable Controller**

PLC Type	Applicable version
FX1S series	V2.00 or later
FX1N series	V2.00 or later

## 2. Specifications

### 2.1 General Specifications

Same as the programmable controller main unit. (Refer to the programmable controller main unit manual)

### 2.2 Power Supply Specifications

Power supplied by internal feed of the programmable controller main unit.

### 2.3 Performance Specifications

**Table 2.1: Performance Specifications**

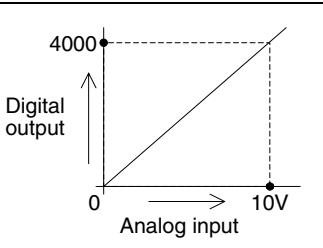
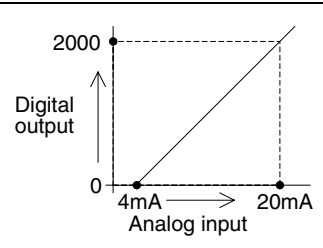
Item	Specification	
	Voltage input	Current input
Range of analog input	DC 0 ~ 10V (input resistance 300k $\Omega$ ) Absolute maximum input: -0.5V, +15V	DC 4 ~ 20mA (input resistance 250 $\Omega$ ) Absolute maximum input: -2mA, +60mA
Digital output	12bit binary	
Resolution	2.5mV (10V / 4000)	8 $\mu$ A {(20mA - 4mA) / 2000}
Integrated accuracy	$\pm$ 1% Against the full scale (0 ~ 10V: $\pm$ 0.1V)	$\pm$ 1% Against the full scale (4 ~ 20mA: $\pm$ 0.16mA)
A/D conversion time	Approx. 30ms [15ms x 2 channels] (D8112 or D8113 are updated after the END instruction)*1	
Input characteristics		
Insulation	No insulation between each channel or the PLC.	
Occupation point	0 points (2AD is not subject to the standard maximum number of control points in the host PLC, as it operated via data registers).	

\*1 The A/D conversion is started following the END statement. A/D conversion of Channel 1 and 2 is performed in turn and not in simultaneous operation. Channel 1 conversion is completed in approximately 15ms, however, at the End statement conversion of the present value stored in D8112 is dependent on PLC scan time. Channel 2 will start at the same time that Channel 1 completes the refresh of D8112.

## 3. Installation



### Caution:

- Cut off all phases of power source before installing / removing or performing wiring work on the master in order to avoid electric shock or damage of product.
- After the installation and wiring etc. replace the PLCs top cover before power ON.



### Note:

- Securely install the expansion board, and fix to the PLC. Defective contact can cause malfunction.
- The tightening torque for fix the board or top cover is 0.3 ~ 0.6 N·m. Tighten securely to avoid malfunction.



### Note:

Only one expansion board can be used per main unit of FX1s and FX1N PLC. Do not try to install two or more expansion boards.  
Moreover, the 2AD cannot be used with the FX1N-EEPROM-8L or the FX1N-5DM.

The following is a generic explanation of how to install a expansion board to the PLC.

- Top cover for expansion board
- M3 self-tapping screw to mount expansion board
- M3 self-tapping screw to fix top cover
- External port for optional equipment
- Expansion board

Note: Do not remove this screw.

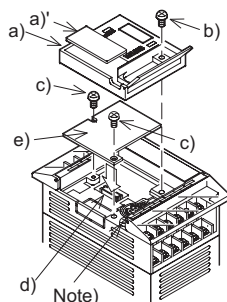

- 1) Remove the top cover of the main unit and keep.
- 2) Plug expansion board "e)" into the external port "d)".
- 3) Fix expansion board to main unit using M3 self-tapping screws "c)". (Tightening torque: 0.3 ~ 0.6N·m)
- 4) Attach top cover for expansion board "a)" removing section "a)" to expose connector etc.
- 5) Secure top cover with M3 self-tapping screw "b)". (Tightening torque: 0.3 ~ 0.6N·m)

## 4. Wiring



### Caution:

Cut off all phases of power source before installing / removing or performing wiring work on the expansion board in order to avoid electric shock or damage of product.



### Note:

- Do not lay signal cable near to high voltage power cable or house them in the same trunking duct. Effects of noise or surge induction may occur. Keep signal cables a safe distance of more than 100 mm (3.94") from these power cables.
- Ground the shield wire or the shield of a shielded cable. Do not, however, ground at the same point as high voltage lines.
- Never solder the end of any cables.  
Make sure that the number of connected cables is not more than the unit has been designed for.
- Never connect cables of a non permitted size.
- Fix cables so that any stress is not directly applied on the terminal block or the cable connection area.
- The terminal tightening torque is 0.5 ~ 0.6 N·m. Tighten securely to avoid malfunction.

### 4.1 Applicable cables

- Use AWG26 ~ 16 for connection with input.
- The terminal tightening torque is 0.5 ~ 0.6 N·m.
- When using a different type of cable, defective contact at the terminal is possible. Use a crimp terminal to achieve a good contact.

**Table 4.1: Liner and Sectional Area**

Linear	Sectional Area (mm <sup>2</sup> )	Terminal
AWG26	0.1288	Stranded cable: Remove sheath, twist core wires, then connect cable. Single cable: Remove sheath, then connect cable.
:	:	
:	:	
AWG16	1.309	

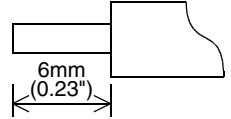

### 4.2 Wiring

The channel not used is short-circuit and uses the terminal "VO+" and the terminal "VI-". The channel number enters "O".

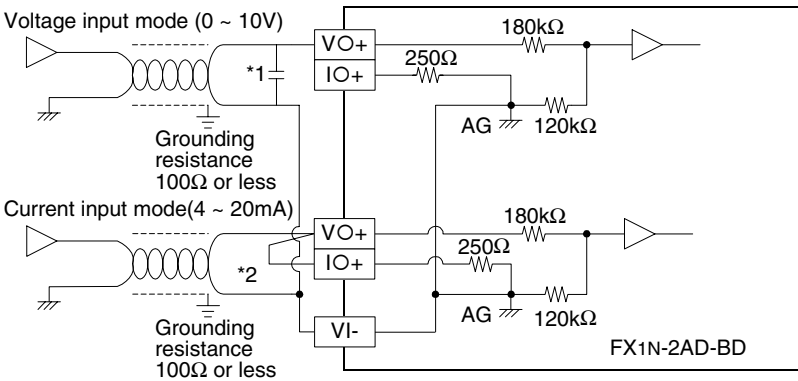

\*1 Connect a 0.1 ~ 0.47μF at 25V DC capacitor in position"\*1" when there is voltage ripple in the voltage input or there will be a lot of noise.

\*2 For current input, short circuit "VO+" and "IO+" as shown in the diagram.

## 5. Example Program

Analog amount (0 ~ 10V, 4 ~ 20mA) input to each channel is stored in data registers (D8112, D8113) as digital values. The values are stored automatically at each END instruction and calculated using the analog to digital conversion characteristic, specified with special auxiliary relays M8112 and M8113.

### 5.1 Allocated Device

**Table 5.1: Allocation of Device**

Device	Description
M8112	Switch of input mode of Ch1 flag OFF: Voltage input mode (0 ~ 10V) ON: Current input mode (4 ~ 20mA)
M8113	Switch of input mode of Ch2 flag OFF: Voltage input mode (0 ~ 10V) ON: Current input mode (4 ~ 20mA)
D8112	Digital value of Ch1
D8113	Digital value of Ch2

### 5.2 Basic Example Program



**Note:**

- Drive M8112 and M8113 which specifies the analog to digital conversion characteristic with M8000 ("a" type contact of the RUN monitor) or M8001 ("b" type contact of the RUN monitor).  
Do not change the ON/OFF state while the analog to digital conversion is operating. The analog to digital conversion is not executed correctly when M8112 or M8113 are turned ON and OFF during the conversion process.
- Do not change the digital value of D8112 or D8113 after A/D conversion in the 2AD, by manipulating the user program, a programming tool, or GOT (graphic operation terminal), etc.

The following program example sets Ch1 in the voltage input mode, Ch2 in the current input mode, with the A/D converted digital value of each channel stored in D0 and D1.

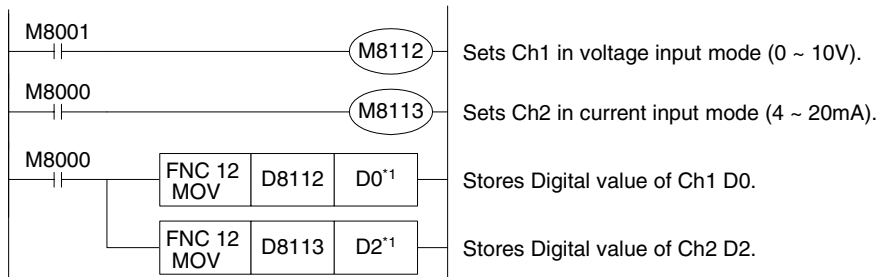

\*1 If a digital value is not stored in D0 or D2, D8112 and D8113 can be used directly for set values and other instructions, etc. of timers and counters.

### 5.3 Example Application Program

As the 2AD does not have Offset and Gain capabilities, if values are required outside the standard specification range, additional program commands are required to either multiply or divide the conversion values. For an example application, please see FX programming manual II.



**Note:**

- Accuracy and resolution of the analog to digital conversion are different from the specification because the additional program commands.
- The original range of the analog input is not changed.

### 5.3.1 Example Application Program 1

In voltage input mode, the 2AD converts analog values from 0 ~ 10V to the digital output of 0 ~ 4000. If using a digital range of 0 ~ 10000 in the program, the range must be converted from 0 ~ 4000 to 0 ~ 10000 as shown in the programming example below. Digital values that are converted from analog values are stored in D8112 or D8113.

The analog input does not have exact resolution of 2.5 mV because the digital value is converted from a range of 0 ~ 4000 to 0 ~ 10000.

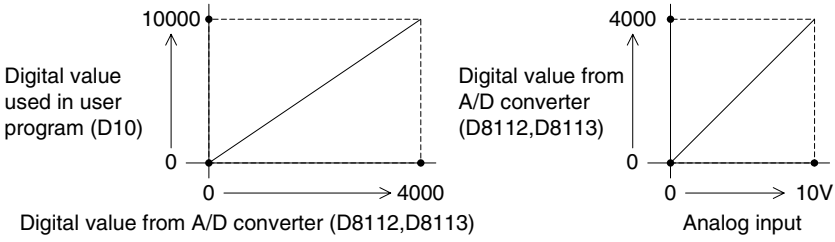

If a digital value in the range of 0 ~ 10000 is used in D10, please see below.

Digital value used in user program:  $D10 = 10 \times (D8112 \text{ or } D8113) \div 4$

The program example based on the equation above is as shown in the figure below. (In Ch1 case)

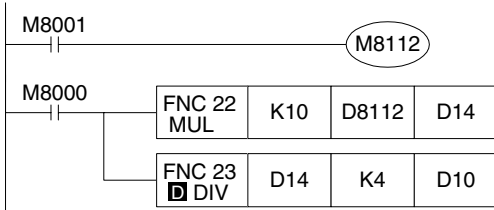

### 5.3.2 Example Application Program 2

In current input mode, the 2AD converts analog values from 4 ~ 20mA to the digital output of 0 ~ 2000. If using a digital range of 4000 ~ 20000 in the program, the range must be converted from 0 ~ 2000 to 4000 ~ 20000 as shown in the programming example below. Digital values that are converted from analog values are stored in D8112 or D8113.

The analog input does not have exact resolution of 8  $\mu$ A because the digital value is converted from a range of 0 ~ 2000 to 4000 ~ 20000.

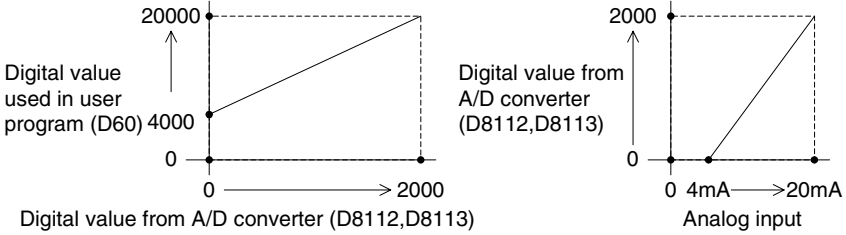

If a digital value in the range of 4000 ~ 20000 is used in D60, please see below.

Digital value used in user program:  $D60 = 8 \times (D8112 \text{ or } D8113) + 4000$

The program example based on the equation above is as shown in the figure below. (In Ch2 case))

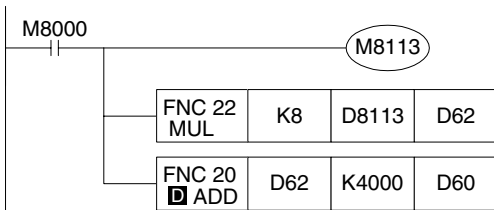

Manual number : JY992D96201

Manual revision : B

Date : JULY 2004



# FX1N-2AD Analog Input Expansion Board

## User's Manual

JY992D96201B

This manual contains text, diagrams and explanations which will guide the reader in the correct installation, safe use and operation of the FX1N-2AD-BD Analog Input Expansion Board and should be read and understood before attempting to install or use the unit. Further information can be found in the associated manuals list below.

Specifications are subject to change without notice

### Guidelines for the Safety of the User and Protection of the FX1N-2AD-BD Analog Input Expansion Board.

This manual has been written to be used by trained and competent personnel. The definition of such a person or persons is as follows:

- Any engineer using the product associated with this manual, should be of a competent nature, trained and qualified to the local and national standards. These engineers should be fully aware of all aspects of safety with regards to automated equipment.
- Any commissioning or service engineer must be of a competent nature, trained and qualified to the local and national standards.
- All operators of the completed equipment should be trained to use that product in a safe and coordinated manner in compliance to established safety practices.

**Note:** The term 'completed equipment' refers to a third party constructed device which contains or uses the product associated with this manual.

### Note's on the Symbols Used in this Manual

At various times through out this manual certain symbols will be used to highlight points of information which are intended to ensure the users personal safety and protect the integrity of equipment.



- Indicates that the identified danger **WILL** cause physical and property damage.



- Indicates that the identified danger could **POSSIBLY** cause physical and property damage.

- Under no circumstances will Mitsubishi Electric be liable or responsible for any consequential damage that may arise as a result of the installation or use of this equipment.
- All examples and diagrams shown in this manual are intended only as an aid to understanding the text, not to guarantee operation. Mitsubishi Electric will accept no responsibility for actual use of the product based on these illustrative examples.
- Owing to the very great variety in possible application of this equipment, you must satisfy yourself as to its suitability for your specific application.

### Associated Manual

Manual Name	Manual Number	Description
FX1S Series Programmable controllers Hardware Manual	JY992D83901	Describes contents related to hardware of the FX1S series PLC, such as specifications, wiring and installation.
FX1N Series Programmable controllers Hardware Manual	JY992D89301	Describes contents related to hardware of the FX1N series PLC, such as specifications, wiring and installation.
FX Series of Programmable controllers Programming Manual II	JY992D88101	Describes instructions in FX1S/FX1N/FX2N/FX2NC series.

Ⓢ Indispensable manual

## 1. Introduction

The FX1N-2AD-BD analog input expansion board (hereafter called "2AD" or "expansion board") is to be installed in an FX1S or FX1N series PLC, to increase the analog input by 2 points.

### 1.1 Features of 2AD

- Analog input of two points can be increased using 2AD. If a 2AD is used, internal mounting in the top of the PLC means that there is no need for a change to the installation area of the PLC.
- Voltage input (0 ~ 10V) or current input (4 ~ 20mA) for analog to digital conversion can be set by switching the auxiliary relays assigned to each channel. Moreover, a digital value after conversion of each channel is stored in special data register allocated to each channel, as shown in the table below. However, the analog to digital conversion characteristic cannot be adjusted.

**Table 1.1: Allocated Device**

Device	Description
M8112	Switch of input mode of Ch1 flag OFF: Voltage input mode (0 ~ 10V) ON: Current input mode (4 ~ 20mA)
M8113	Switch of input mode of Ch2 flag OFF: Voltage input mode (0 ~ 10V) ON: Current input mode (4 ~ 20mA)
D8112	Digital value of Ch1
D8113	Digital value of Ch2

### 1.2 External Dimensions and Each Part Name

Dimensions: mm (inches) Accessory: Top cover for board ×1, M3 self-tapping screw ×3 (to fix top cover ×1, to mount board ×2)

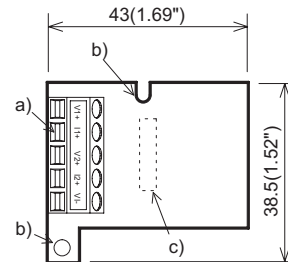

- Terminals to connect analog module  
The top face of this terminal block is higher than the top face of the panel cover of the programmable controller by approximately 7mm (0.28").

**Table 1.2: Allocation Terminal**

Terminal name	Content
V1+	Voltage input terminal for channel 1(Ch1)
I1+	Current input terminal for channel 1(Ch1)
V2+	Voltage input terminal for channel 2(Ch2)
I2+	Current input terminal for channel 2(Ch2)
VI-	Common terminal for each channel

- Mounting holes (2- Ø4.0 / 0.16")
- Connector for PLC

### 1.3 System Configuration

- Only one expansion board can be used on one FX1S and FX1N PLC main unit. Do not try to install two or more expansion boards. (They will not function)
- The 2AD cannot be used with a FX1N-EEPROM-8L or FX1N-5DM.

### 1.4 Applicable PLC

**Table 1.3: Applicable Programmable Controller**

PLC Type	Applicable version
FX1S series	V2.00 or later
FX1N series	V2.00 or later

## 2. Specifications

### 2.1 General Specifications

Same as the programmable controller main unit. (Refer to the programmable controller main unit manual)

### 2.2 Power Supply Specifications

Power supplied by internal feed of the programmable controller main unit.

### 2.3 Performance Specifications

**Table 2.1: Performance Specifications**

Item	Specification	
	Voltage input	Current input
Range of analog input	DC 0 ~ 10V (input resistance 300kΩ) Absolute maximum input: -0.5V, +15V	DC 4 ~ 20mA (input resistance 250Ω) Absolute maximum input: -2mA, +60mA
Digital output	12bit binary	
Resolution	2.5mV (10V /4000)	8μA {(20mA - 4mA) /2000}
Integrated accuracy	±1% Against the full scale (0 ~ 10V: ±0.1V)	±1% Against the full scale (4 ~ 20mA: ±0.16mA)
A/D conversion time	Approx. 30ms [15ms x 2 channels] (D8112 or D8113 are updated after the END instruction)*1	
Input characteristics		
Insulation	No insulation between each channel or the PLC.	
Occupation point	0 points (2AD is not subject to the standard maximum number of control points in the host PLC, as it operated via data registers).	

\*1 The A/D conversion is started following the END statement. A/D conversion of Channel 1 and 2 is performed in turn and not in simultaneous operation. Channel 1 conversion is completed in approximately 15ms, however, at the End statement conversion of the present value stored in D8112 is dependent on PLC scan time. Channel 2 will start at the same time that Channel 1 completes the refresh of D8112.

## 3. Installation



### Caution:

- Cut off all phases of power source before installing / removing or performing wiring work on the master in order to avoid electric shock or damage of product.
- After the installation and wiring etc. replace the PLCs top cover before power ON.



### Note:

- Securely install the expansion board, and fix to the PLC. Defective contact can cause malfunction.
- The tightening torque for fix the board or top cover is 0.3 ~ 0.6 N·m. Tighten securely to avoid malfunction.



### Note:

Only one expansion board can be used per main unit of FX1S and FX1N PLC. Do not try to install two or more expansion boards. Moreover, the 2AD cannot be used with the FX1N-EEPROM-8L or the FX1N-5DM.

The following is a generic explanation of how to install a expansion board to the PLC.

- Top cover for expansion board
- M3 self-tapping screw to mount expansion board
- M3 self-tapping screw to fix top cover
- External port for optional equipment
- Expansion board

Note: Do not remove this screw.

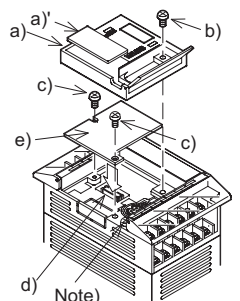

- Remove the top cover of the main unit and keep.
- Plug expansion board "e" into the external port "d".
- Fix expansion board to main unit using M3 self-tapping screws "c". (Tightening torque: 0.3 ~ 0.6N·m)
- Attach top cover for expansion board "a" removing section "a'" to expose connector etc.
- Secure top cover with M3 self-tapping screw "b)". (Tightening torque: 0.3 ~ 0.6N·m)



## 4. Wiring



### Caution:

Cut off all phases of power source before installing / removing or performing wiring work on the expansion board in order to avoid electric shock or damage of product.



### Note:

- Do not lay signal cable near to high voltage power cable or house them in the same trunking duct. Effects of noise or surge induction may occur. Keep signal cables a safe distance of more than 100 mm (3.94") from these power cables.
- Ground the shield wire or the shield of a shielded cable. Do not, however, ground at the same point as high voltage lines.
- Never solder the end of any cables. Make sure that the number of connected cables is not more than the unit has been designed for.
- Never connect cables of a non permitted size.
- Fix cables so that any stress is not directly applied on the terminal block or the cable connection area.
- The terminal tightening torque is 0.5 ~ 0.6 N·m. Tighten securely to avoid malfunction.

### 4.1 Applicable cables

- Use AWG26 ~ 16 for connection with input.
- The terminal tightening torque is 0.5 ~ 0.6 N·m.
- When using a different type of cable, defective contact at the terminal is possible. Use a crimp terminal to achieve a good contact.

Table 4.1: Liner and Sectional Area

Linear	Sectional Area (mm <sup>2</sup> )	Terminal
AWG26	0.1288	Stranded cable: Remove sheath, twist core wires, then connect cable.
:	:	:
AWG16	1.309	Single cable: Remove sheath, then connect cable.

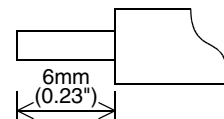

### 4.2 Wiring

The channel not used is short-circuit and uses the terminal "VO+" and the terminal "VI-". The channel number enters "O".

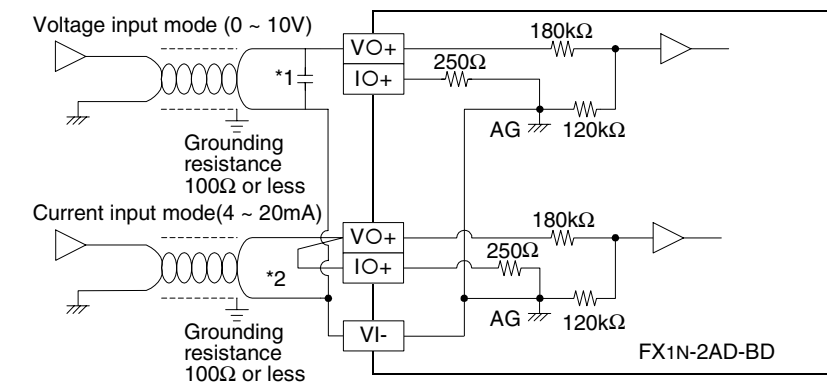

\*1 Connect a 0.1 ~ 0.47μF at 25V DC capacitor in position\*\*1 when there is voltage ripple in the voltage input or there will be a lot of noise.

\*2 For current input, short circuit "VO+" and "IO+" as shown in the diagram.

## 5. Example Program

Analog amount (0 ~ 10V, 4 ~ 20mA) input to each channel is stored in data registers (D8112, D8113) as digital values. The values are stored automatically at each END instruction and calculated using the analog to digital conversion characteristic, specified with special auxiliary relays M8112 and M8113.

### 5.1 Allocated Device

Table 5.1: Allocation of Device

Device	Description
M8112	Switch of input mode of Ch1 flag OFF: Voltage input mode (0 ~ 10V) ON: Current input mode (4 ~ 20mA)
M8113	Switch of input mode of Ch2 flag OFF: Voltage input mode (0 ~ 10V) ON: Current input mode (4 ~ 20mA)
D8112	Digital value of Ch1
D8113	Digital value of Ch2

### 5.2 Basic Example Program



#### Note:

- Drive M8112 and M8113 which specifies the analog to digital conversion characteristic with M8000 ("a" type contact of the RUN monitor) or M8001 ("b" type contact of the RUN monitor). Do not change the ON/OFF state while the analog to digital conversion is operating. The analog to digital conversion is not executed correctly when M8112 or M8113 are turned ON and OFF during the conversion process.
- Do not change the digital value of D8112 or D8113 after A/D conversion in the 2AD, by manipulating the user program, a programming tool, or GOT (graphic operation terminal), etc.

The following program example sets Ch1 in the voltage input mode, Ch2 in the current input mode, with the A/D converted digital value of each channel stored in D0 and D1.

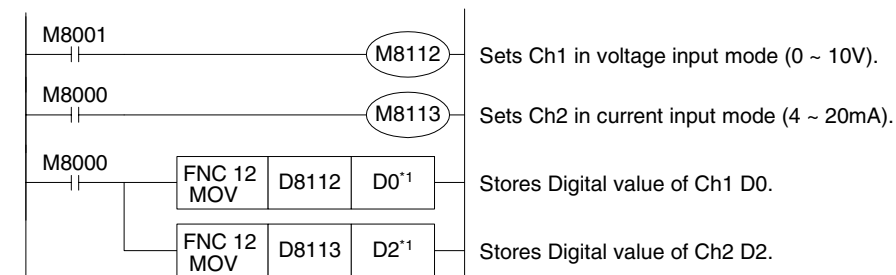

\*1 If a digital value is not stored in D0 or D2, D8112 and D8113 can be used directly for set values and other instructions, etc. of timers and counters.

### 5.3 Example Application Program

As the 2AD does not have Offset and Gain capabilities, if values are required outside the standard specification range, additional program commands are required to either multiply or divide the conversion values. For an example application, please see FX programming manual II.



#### Note:

- Accuracy and resolution of the analog to digital conversion are different from the specification because the additional program commands.
- The original range of the analog input is not changed.

### 5.3.1 Example Application Program 1

In voltage input mode, the 2AD converts analog values from 0 ~ 10V to the digital output of 0 ~ 4000. If using a digital range of 0 ~ 10000 in the program, the range must be converted from 0 ~ 4000 to 0 ~ 10000 as shown in the programming example below. Digital values that are converted from analog values are stored in D8112 or D8113.

The analog input does not have exact resolution of 2.5 mV because the digital value is converted from a range of 0 ~ 4000 to 0 ~ 10000.

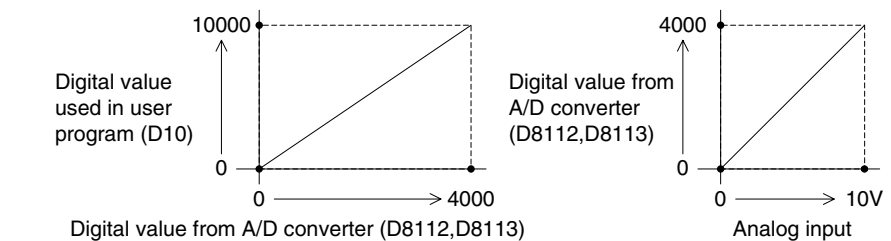

If a digital value in the range of 0 ~ 10000 is used in D10, please see below.

Digital value used in user program: D10 = 10 × (D8112 or D8113) ÷ 4

The program example based on the equation above is as shown in the figure below. (In Ch1 case)

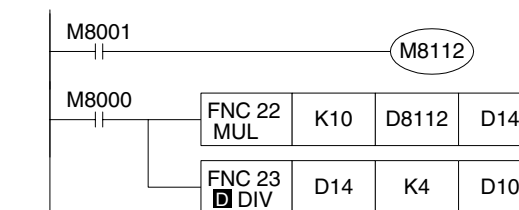

### 5.3.2 Example Application Program 2

In current input mode, the 2AD converts analog values from 4 ~ 20mA to the digital output of 0 ~ 2000. If using a digital range of 4000 ~ 20000 in the program, the range must be converted from 0 ~ 2000 to 4000 ~ 20000 as shown in the programming example below. Digital values that are converted from analog values are stored in D8112 or D8113.

The analog input does not have exact resolution of 8 μA because the digital value is converted from a range of 0 ~ 2000 to 4000 ~ 20000.

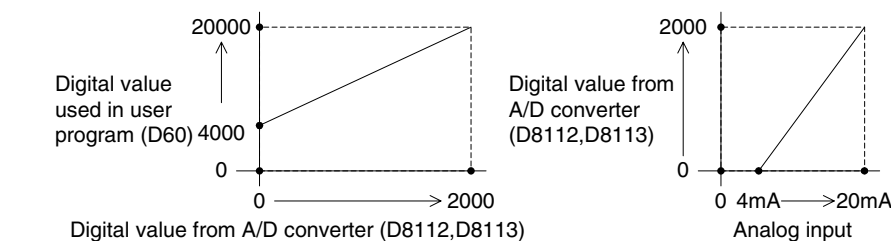

If a digital value in the range of 4000 ~ 20000 is used in D60, please see below.

Digital value used in user program: D60 = 8 × (D8112 or D8113) + 4000

The program example based on the equation above is as shown in the figure below. (In Ch2 case)

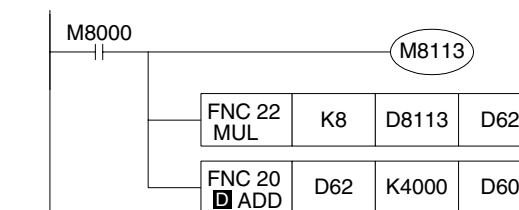

Manual number : JY992D96201

Manual revision : B

Date : JULY 2004