



<b>Identification</b>	Type	BOX-M12-3L4
	Part-No.	400050
<b>Description</b>		
	M12 Actuator sensor boxes IP 68 with LED indication and connected PUR cable 4-way, 8-way / 3-pole + PE c-track compatible, halogen free	
<b>Technical data</b>		
Nominal voltage	DC 24 V	
Nominal voltage range	10 – 30	
Rated current	max. 2A per channel	
Amperage range	max. total 12 A	
Number of terminations	3-pole + PE	
Slots	4-way	
Cable length (m)	5.0 m	
Status Indication	Supply: 2 × LED green, I/O: each 1 × LED yellow	
Current Consumption per LED	< 10 mA / LED	
Coding	A	
Contact resistance	< 5 mΩ	
<b>General</b>		
Form	M12 × 1, connector	

13.11.2013 – Subject to technical modification

Part-No. 400050

USA: LUTZE INC.

13330 South Ridge Drive • Charlotte, NC 28273, USA  
Tel. +1 (704) 504-0222 • Fax +1 (704) 504-0223  
www.lutze.com • info@lutze.com

United Kingdom: LÜTZE Ltd.

Unit 3, Sandy Hill Park  
Sandy Way, Amington • GB-Tamworth, Staffs B77 4DU  
Tel. +44 (0)1827 31333-0 • Fax +44 (0)1827 31333-2  
www.lutze.com • sales.gb@lutze.co.uk



SYSTEMATIC TECHNOLOGY

## Technical data sheet - Actuator sensor interface

Rated insulation voltage (EN 50178)	32 V
Test voltage	1.0 kV
Pollution degree	3
Insulation resistance	$> 10^9 \Omega$
Contact resistance	$< 5 \text{ m}\Omega$
Class of flammability according to UL 94	V0
Protection class	68, in screwed condition
Housing material	PBT grey
Contact material	CuZn, gold-plated
Thread material	CuSn nickel plated
Gasket	Viton
Cable construction	$3 \times 1.0 + 4 \times 0.34 \text{ mm}^2$
Cable jacket	PUR
Conductor insulation	PP coloured
Cable diameter	7.5 mm
Bending radius	fixed: $4 \times D$ , cable track: $10 \times D$
Storage temperature range	$-40 \text{ }^\circ\text{C} - 90 \text{ }^\circ\text{C}$
Operation temperature range	$-20 \text{ }^\circ\text{C} - 80 \text{ }^\circ\text{C}$
Temperature range cable fixed	$-40 \text{ }^\circ\text{C} - 80 \text{ }^\circ\text{C}$
Temperature range cable moving	$-5 \text{ }^\circ\text{C} - 80 \text{ }^\circ\text{C}$
Class of flammability according to UL 94	V0
Dimensions (w × h × d)	$60.0 \times 25.0 \times 102.0 \text{ mm}$
Weight (kg/piece)	0.860
Approvals	cURus
PU	1
C-track chain properties	Type C

### C-track chain properties

C-track chain properties	Type A	Type B	Type C
Bending cycles min.	5 million	4 million	2 million
Minimum bending radius	$10 \times D$	$10 \times D$	$10 \times D$
Travel distance	10 m	10 m	5 m
Acceleration	$7 \text{ m/s}^2$	$10 \text{ m/s}^2$	$5 \text{ m/s}^2$
Speed	3 m/s	3 m/s	3 m/s
Conduction properties (TYPE A+B+C)	PUR halogen free for extreme demands <ul style="list-style-type: none"><li>• Very good chemical stability</li><li>• Very resistant to oils and lubricants</li><li>• Very high abrasion resistance</li><li>• Halogen free</li><li>• Silicone free, free of paint wetting impairment substances</li><li>• Resistant to microbes and hydrolysis</li><li>• Good UV stability</li></ul>		

13.11.2013 – Subject to technical modification

Part-No. 400050

USA: LUTZE INC.

13330 South Ridge Drive • Charlotte, NC 28273, USA

Tel. +1 (704) 504-0222 • Fax +1 (704) 504-0223

www.lutze.com • info@lutze.com

United Kingdom: LÜTZE Ltd.

Unit 3, Sandy Hill Park

Sandy Way, Amington • GB-Tamworth, Staffs B77 4DU

Tel. +44 (0)1827 31333-0 • Fax +44 (0)1827 31333-2

www.lutze.com • sales.gb@lutze.co.uk



SYSTEMATIC TECHNOLOGY

# Technical data sheet • Actuator sensor interface

## Dimensions

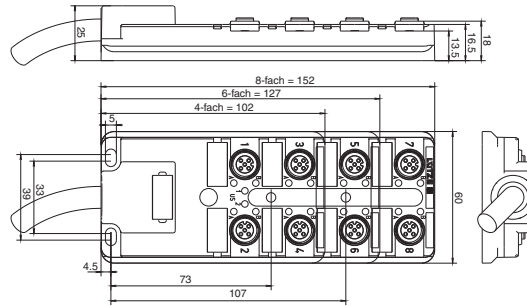

## PIN assignment

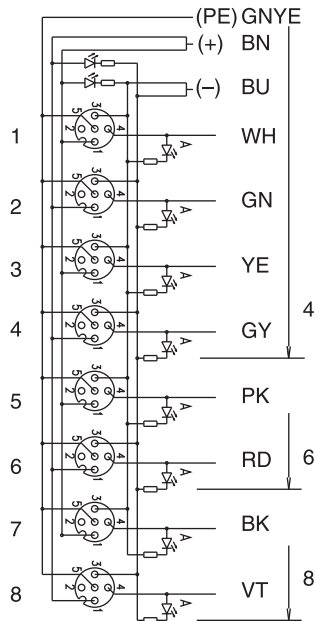

## Logo



## Accessories

Accessories	Article number	Type	PU
protective cover M12	499994	SK M12	50
T-junction M12 on 2 × M12	490026	T-connector M12/ M12	10
T-junction M12 on 2 × M8	490038	T-connector M12/ M8	10

13.11.2013 – Subject to technical modification

Part-No. 400050

USA: LUTZE INC.

13330 South Ridge Drive • Charlotte, NC 28273, USA

Tel. +1 (704) 504-0222 • Fax +1 (704) 504-0223

www.lutze.com • info@lutze.com

United Kingdom: LÜTZE Ltd.

Unit 3, Sandy Hill Park

Sandy Way, Amington • GB-Tamworth, Staffs B77 4DU

Tel. +44 (0)1827 31333-0 • Fax +44 (0)1827 31333-2

www.lutze.com • sales.gb@lutze.co.uk



SYSTEMATIC TECHNOLOGY