

3-phase switching power supply
regulated, 480 W, 3-phase



Identification	Type	WRA 480-24
	Part-No.	722805

Input

Nominal voltage	3× AC 380–500 V
Operation voltage range	3× AC 340–576 V; 3× DC 480–820 V
Line frequency	47 Hz – 63 Hz
Rated current	$U_i = AC 400 V: 1.5 A / U_i = AC 480 V: 1.2 A$
Inrush current	20 A
Internal fuse	T3, 15 A / per phase
External fuse	Automatic: 3 × B 10 A, C 6 A
Power Factor Correction P.F.C.	0.7

Load Side

Rated voltage output	DC 24 V
Rated current output	20 A
Low power loss	58 W (AC 380 V)
Voltage trim range	22.5 –28.5 V
Accuracy	1 %
Line regulation	±1 %
Load regulation	Single ±1 %, Parallel ±5 %
Temperature coefficient	±0.03 % / °C
Ripple & Noise	100 mV

08.11.2013 – Subject to technical modification

Part-No. 722805

USA: LUTZE INC.

13330 South Ridge Drive • Charlotte, NC 28273, USA
Tel. +1 (704) 504-0222 • Fax +1 (704) 504-0223
www.lutze.com • info@lutze.com

United Kingdom: LÜTZE Ltd.

Unit 3, Sandy Hill Park
Sandy Way, Amington • GB-Tamworth, Staffs B77 4DU
Tel. +44 (0)1827 31333-0 • Fax +44 (0)1827 31333-2
www.lutze.com • sales.gb@lutze.co.uk



SYSTEMATIC TECHNOLOGY

Technical data sheet • Power supply

Hold up time	min. 20 ms
Status indication DC ON LED green	≥17.6–19.4 V
Status indication DC LOW LED red	≤17.6–19.4 V
Parallel/redundant operation	max 3 devices with 90 % load current each, switching with switch S/P
Efficiency	90 %
Rated over load protection	115–135 %
Over voltage protection	125–137 %
Short circuit characteristics	Current limit (C) / Hiccup-Mode (D); switching with switch C/D Hiccup-Mode: deactivation within 3s and restart after 30s

General

Switching frequency	approx. 80 kHz
Insulation voltage input/output	3.0 kV _{eff}
Insulation voltage input / ground	AC 1.5 kV _{eff}
Insulation resistance at DC 500 V	100 MΩ
Operation temperature range	-25 °C – 71 °C (derating)
Derating	-2.5% / °C starting at 61 °C
Storage temperature range	-25 °C – 85 °C
M.T.B.F.	411000 h
Relative humidity	20–90% RH, non-condensing
Dimensions (w × h × d)	150.0 × 125.0 × 116.0 mm
Cooling	Natural air cooling, 25 mm distance on all sides
Installation position	vertical
Housing material	metal
Protection class	IP 20
Field installation	rail TS 35 (EN 50022)
Application height	3000 m
IP rating	I (SELV, PELV)
Overvoltage category	II
Pollution degree	2
Weight (kg/piece)	1.750
Termination	Screw terminal: 0.2–4.0 mm ² , max. 0.62 Nm
Approvals	UL: UL 508 listed; cUL: UL 60950-1 accepted; TÜV: EN 60950-1; CE: EN 61000-6-3 / EN 55022 Class B, EN 61000-3-2, EN 61000-3-3, EN 61000-6-2, EN 55024

Monitoring

DC ON Control (Rdy)	Normally open
Switching voltage	DC 60 V
Switching current	max. 300 mA
Insulation voltage	DC 500 V

08.11.2013 – Subject to technical modification

Part-No. 722805

USA: LUTZE INC.

13330 South Ridge Drive • Charlotte, NC 28273, USA

Tel. +1 (704) 504-0222 • Fax +1 (704) 504-0223

www.lutze.com • info@lutze.com

United Kingdom: LÜTZE Ltd.

Unit 3, Sandy Hill Park

Sandy Way, Amington • GB-Tamworth, Staffs B77 4DU

Tel. +44 (0)1827 31333-0 • Fax +44 (0)1827 31333-2

www.lutze.com • sales.gb@lutze.co.uk



SYSTEMATIC TECHNOLOGY

Technical data sheet • Power supply

Dimensions

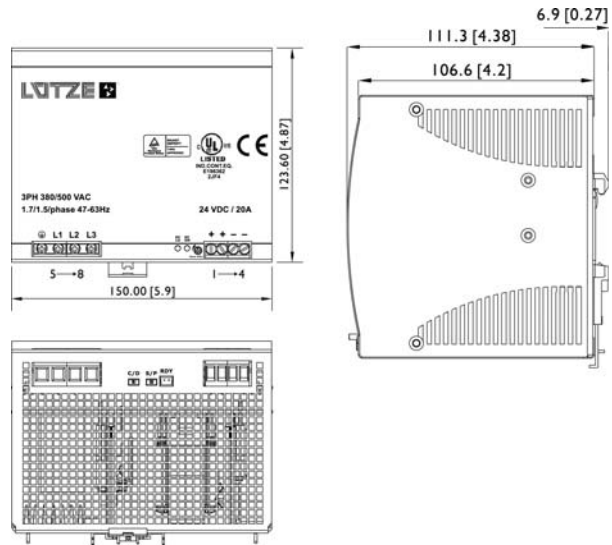

PIN assignment

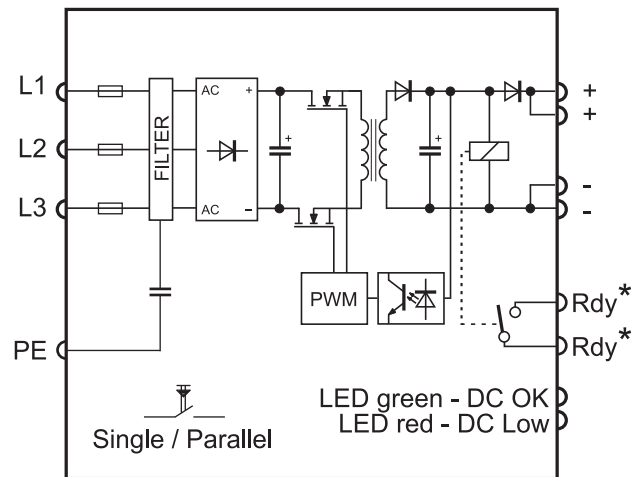

* for 24V version only

08.11.2013 – Subject to technical modification

Part-No. 722805

USA: LUTZE INC.

13330 South Ridge Drive • Charlotte, NC 28273, USA
 Tel. +1 (704) 504-0222 • Fax +1 (704) 504-0223
 www.lutze.com • info@lutze.com

United Kingdom: LÜTZE Ltd.

Unit 3, Sandy Hill Park
 Sandy Way, Amington • GB-Tamworth, Staffs B77 4DU
 Tel. +44 (0)1827 31333-0 • Fax +44 (0)1827 31333-2
 www.lutze.com • sales.gb@lutze.co.uk



SYSTEMATIC TECHNOLOGY

Derating

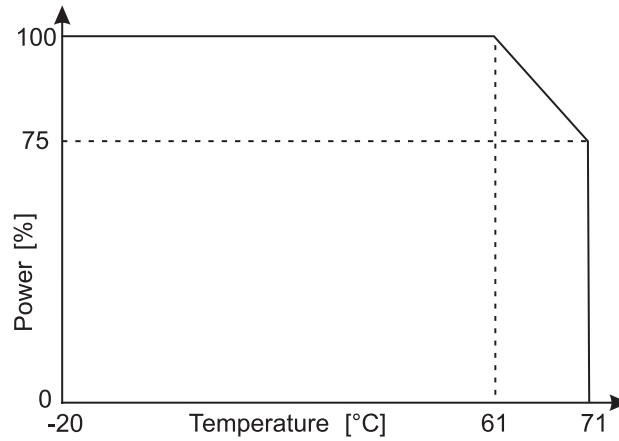

Parallel/redundant mode

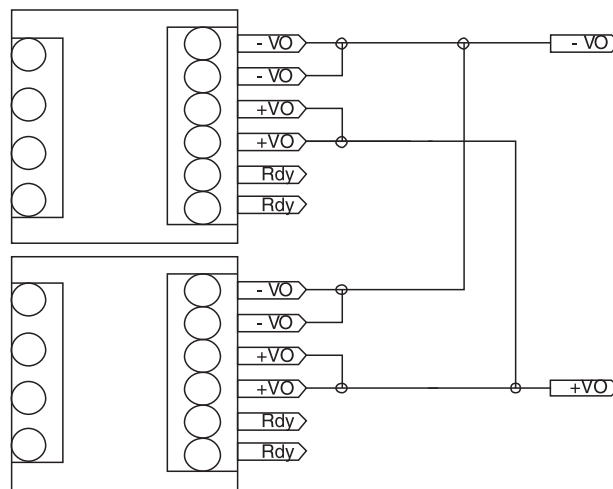

08.11.2013 – Subject to technical modification

Part-No. 722805

USA: LUTZE INC.

13330 South Ridge Drive • Charlotte, NC 28273, USA

Tel. +1 (704) 504-0222 • Fax +1 (704) 504-0223

www.lutze.com • info@lutze.com

United Kingdom: LÜTZE Ltd.

Unit 3, Sandy Hill Park

Sandy Way, Amington • GB-Tamworth, Staffs B77 4DU

Tel. +44 (0)1827 31333-0 • Fax +44 (0)1827 31333-2

www.lutze.com • sales.gb@lutze.co.uk



SYSTEMATIC TECHNOLOGY

Short circuit characteristics

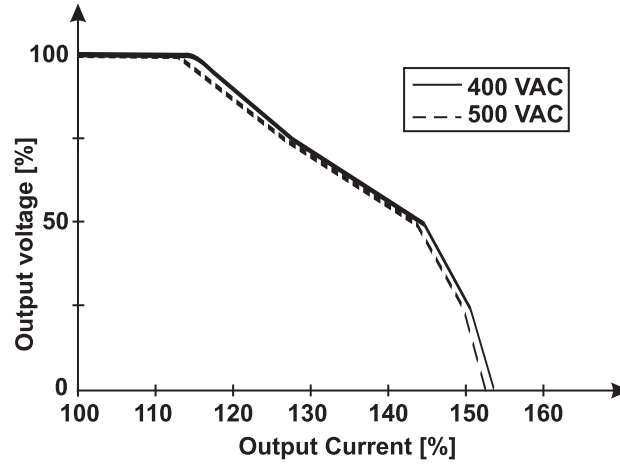

08.11.2013 – Subject to technical modification

Part-No. 722805

USA: LUTZE INC.

13330 South Ridge Drive • Charlotte, NC 28273, USA

Tel. +1 (704) 504-0222 • Fax +1 (704) 504-0223

www.lutze.com • info@lutze.com

United Kingdom: LÜTZE Ltd.

Unit 3, Sandy Hill Park

Sandy Way, Amington • GB-Tamworth, Staffs B77 4DU

Tel. +44 (0)1827 31333-0 • Fax +44 (0)1827 31333-2

www.lutze.com • sales.gb@lutze.co.uk



SYSTEMATIC TECHNOLOGY